

RUDOLF

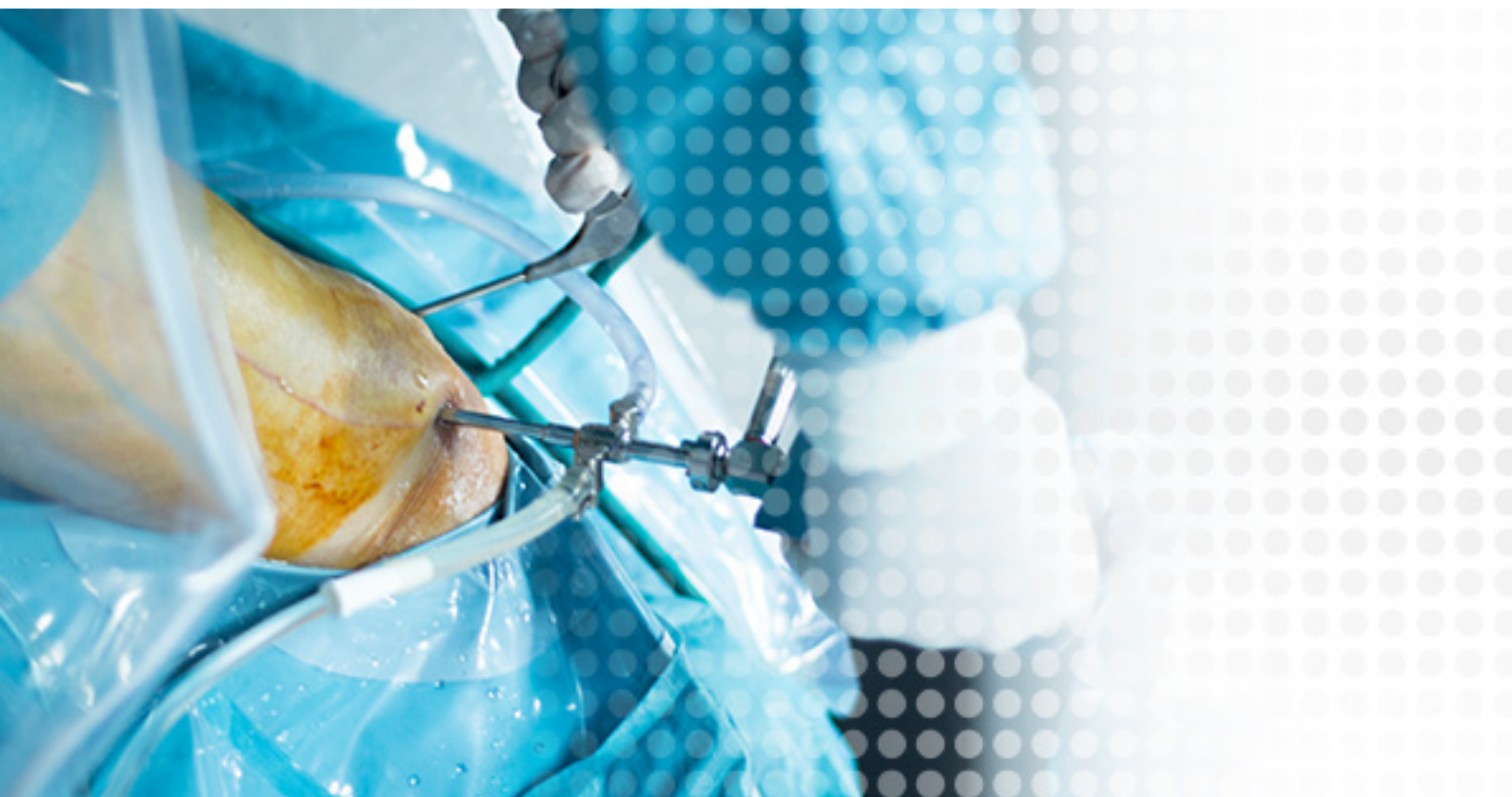

# Arthroscopy Basic

Instruments, Optics, Accessories





# Qualität Made by RUDOLF Medical

## *Quality Made by RUDOLF Medical*

**RUDOLF Instrumente und Endoskope** sind auch heute noch „Made in Germany“ und werden mit neuester, computergesteuerter Präzisionstechnik gefertigt und von Spezialisten in Handarbeit perfektioniert. RUDOLF Produkte sind das Ergebnis konsequenter Entwicklungs- und Forschungsarbeit in Kooperation mit unseren Anwendern. Unsere langjährige Erfahrung in der Produktion von chirurgischen Instrumenten spiegelt sich in Qualität und Leistung wieder. RUDOLF Hightech-Produkte für die Arthroskopie unterstützen Sie bei der präzisen und schonenden Behandlung von Gelenkdefekten.

**Chirurgische Instrumente** aus dem Hause RUDOLF sind eine Investition in die Zukunft und zeichnen sich durch Qualität und Langlebigkeit aus.



*RUDOLF instruments and endoscopes are still „Made in Germany“ and are manufactured with the latest, computer-controlled precision technology and hand-finished by specialists. RUDOLF products are the result of consequent development and research work in cooperation with our end user. Our long of experience in the production of surgical instruments is reflected in quality and performance. RUDOLF high-tech products for arthroscopy support you in the precise and gentle treatment of joint defects.*

**Surgical instruments** from RUDOLF are an investment in the future and are outstanding for their quality and durability.





# RUDOLF Medical Endoskope

## RUDOLF Medical Endoscopes



Alle **RUDOLF MEDICAL** Endoskope werden nach höchsten Anforderungen an Präzision und Genauigkeit entwickelt und gefertigt.

All **RUDOLF MEDICAL** Endoscopes are developed according to the highest demands on precision and accuracy and are manufactured.

### Endoskope - Technische Merkmale

Optische Systeme entsprechen den Anforderungen für **HD (High Definition)**:

- Neueste Generation von Lichtfaser für beste Bildausleuchtung
- Höhere Tiefenschärfe bei maximaler Helligkeit, exzellentem Kontrast und brillanter Detailtreue
- Optimierung der optischen Systeme auf die Anforderungen der jeweiligen Anwendung
- Höchste Lebensdauer durch den Einsatz von hochwertigen Materialien (Gold, Saphirglas) in Verbindung mit modularer Fertigungstechnik.

### Endoscopes - Technical Features

The optical systems designed according to the demands for **HD (High Definition)**:

- Latest generation of illumination fibers for highest illumination level
- Increased depth of field at maximum luminosity, excellent contrast and brilliant detail rendition
- Optical systems especially designed according to the needs for the specific application
- Maximum service life thanks to the use of high-quality materials (gold, sapphire glass) in conjunction with modular production technology.

## Endoskope für Arthroskopie

### Endoscopes for Arthroscopy

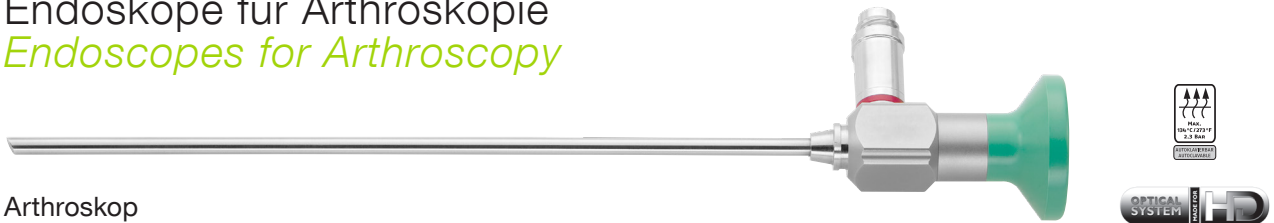

Arthroskop  
Arthroscope

Kennfarbe Colour code	Blickrichtung Direction of view	Durchmesser Diameter	Nutzlänge (NL) Working length (WL)	Bestell-Nr. Ordering no.
grün green	0°	4.0 mm	175 mm – 7"	<b>AT140-000</b>
rot red	30°	4.0 mm	175 mm – 7"	<b>AT140-030</b>
gelb yellow	70°	4.0 mm	175 mm – 7"	<b>AT140-070</b>



Antibeslagmittel für Endoskope,  
steril, 30 ml  
Antifog solution for endoscopes,  
sterile, 30 ml

**RU 8880-05**

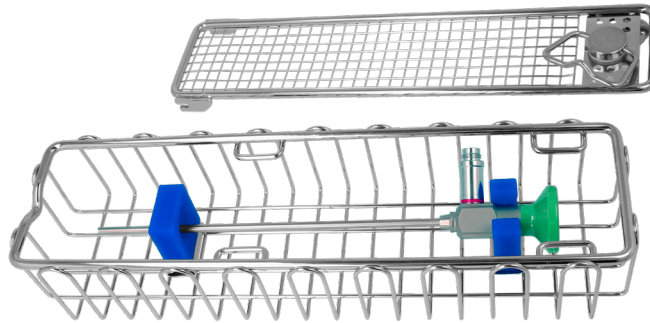

Siebkorb für ein Endoskop  
*Wire basket for one endoscope*

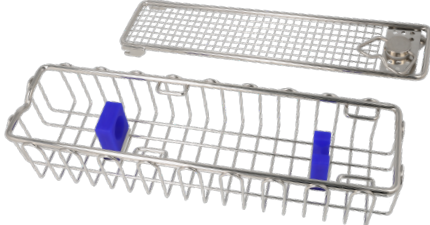
Beschreibung <i>Description</i>	Abmessungen (LxBxH) <i>Dimensions (l x w x h)</i>	Modell <i>Model</i>	Bestell-Nr. <i>Ordering no.</i>
Für Endoskop von 175 mm <i>For endoscop 175 mm</i>	290 x 80 x 52 mm		<b>RU8908-01</b>





Kunststoffhülse  
*Plastic tube*

Beschreibung <i>Description</i>	Abmessungen (L) <i>Dimensions (l)</i>	Modell <i>Model</i>	Bestell-Nr. <i>Ordering no.</i>
Kunststoffhülse für Optiken bis Ø 5 mm <i>Plastic tube for endoscopes up to Ø 5 mm</i>	190 mm – 7½"		<b>RZ010-000</b>

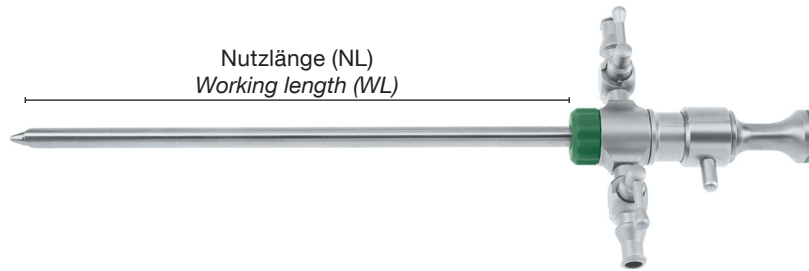

Arthroskopschäfte, Ø 5,5 mm  
für Endoskope Ø4,0mm und Nutzlänge 175 mm  
*Arthroscope Sheaths, Ø 5.5 mm  
for Endoscopes Ø4.0mm and Working Length 175 mm*



Schaft mit **drehbarem** Spülanschluss, 2 Hähne  
*Sheath with **rotatable** irrigation connection, 2 stopcocks*

Blickrichtung <i>Direction of view</i>	Nutzlänge (NL) <i>Working length (WL)</i>	Modell <i>Model</i>	Bestell-Nr. <i>Ordering no.</i>
 UNIVERSAL	143 mm		<b>AT040-001</b>
 30°	143 mm		<b>AT040-002</b>

Schaft mit **drehbarem** Spülanschluss, 2 Hähne  
*Sheath with **rotatable** irrigation connection, 2 stopcocks*

Blickrichtung <i>Direction of view</i>	Nutzlänge (NL) <i>Working length (WL)</i>	Modell <i>Model</i>	Bestell-Nr. <i>Ordering no.</i>
 UNIVERSAL	143 mm		<b>AT040-101</b>
 30°	143 mm		<b>AT040-102</b>





Pflegefett für Hähne, 40g  
*Lubricant for stopcocks, 40g*

**RU 8880-50**

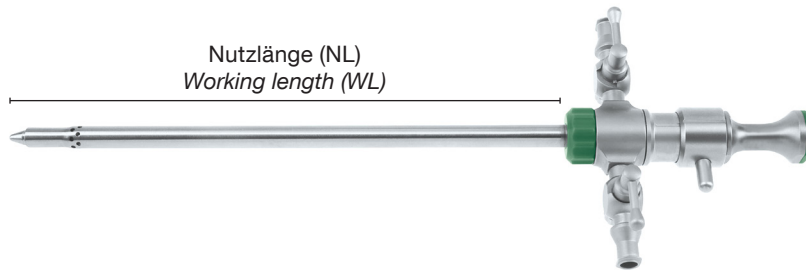

High-Flow Arthroskopschäfte, Ø 6,0 mm  
 für Endoskope Ø4,0mm und Nutzlänge 175 mm  
*High-Flow Arthroscope Sheaths, Ø 6.0 mm  
 for Endoscopes Ø4.0mm and Working Length 175 mm*



Schaft mit **drehbarem** Spülanschluss, 2 Hähne  
*Sheath with **rotatable** irrigation connection, 2 stopcocks*

Blickrichtung <i>Direction of view</i>	Nutzlänge (NL) <i>Working length (WL)</i>	Modell <i>Model</i>	Bestell-Nr. <i>Ordering no.</i>
  UNIVERSAL	143 mm		<b>AT040-201</b>

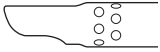
Schaft mit **festem** Spülanschluss, 2 Hähne  
*Sheath with **fixed** irrigation connection, 2 stopcocks*

Blickrichtung <i>Direction of view</i>	Nutzlänge (NL) <i>Working length (WL)</i>	Modell <i>Model</i>	Bestell-Nr. <i>Ordering no.</i>
  UNIVERSAL	146 mm		<b>AT040-211</b>



Pflegefett für Hähne, 40g  
*Lubricant for stopcocks, 40g*

**RU 8880-50**

# Trokare / Obturatoren



## Trocars / Obturators



für Arthroskopschäfte mit Ø5,5 mm  
for Arthroscope Sheaths with Ø5.5 mm

Nutzlänge (NL)  
Working length (WL)





Modell Model	Beschreibung Description	Durchmesser Diameter	Nutzlänge (NL) Working length (WL)	Bestell-Nr. Ordering no.
	Dreikant, schneidend Triangular, sharp	4.0 mm	175 mm – 7"	<b>AT040-121</b>
	Kegelförmig, stumpf Conical, blunt	4.0 mm	175 mm – 7"	<b>AT040-122</b>

für Arthroskopschäfte mit Ø6,0 mm, Ø6,5 mm  
for Arthroscope Sheaths with Ø6.0 mm, Ø6.5 mm

Nutzlänge (NL)  
Working length (WL)







Modell Model	Beschreibung Description	Durchmesser Diameter	Nutzlänge (NL) Working length (WL)	Bestell-Nr. Ordering no.
	Dreikant, schneidend Triangular, sharp	4.3 mm	175 mm – 7"	<b>AT040-021</b>
	Kegelförmig, stumpf Conical, blunt	4.3 mm	175 mm – 7"	<b>AT040-022</b>
	Kugelförmig Ball-shaped	4.3 mm	175 mm – 7"	<b>AT040-023</b>

# Inflow-Spülkanülen

## Inflow Irrigation Cannulas

### SET AT045-001

Beschreibung Description	Modell Model
Inflow-Spülkanüle, Ø 4,5 mm Inflow irrigation cannula, Ø 4.5 mm <b>AT045-009</b>	
Infusionsadapter Infusion adapter <b>AT045-010</b>	 1/1
Trocar für Kanüle, dreikant, schneidend Trocar for cannula triangular, sharp <b>AT045-011</b>	
Obturator, stumpf Obturator, blunt <b>AT045-012</b>	



## SET AT045-040

Beschreibung <i>Description</i>	Modell <i>Model</i>
Inflow-Spülkanüle, (NL) 70 mm, Ø 3,2 mm, Luer-Lock, mit Hahn <i>Inflow-irrigation cannula, (WL) 70 mm, Ø 3.2 mm, Luer-Lock, with stopcock</i>  AT045-023	
Trokardorn, für Spülkanüle Ø 3,2 mm, mit Luer-Lock <i>Trocar spike, for cannula Ø 3.2 mm, Luer-Lock</i>  AT045-021	
Obturator, für Spülkanüle Ø 3,2 mm, mit Luer-Lock <i>Obturator, for cannula Ø 3.2 mm, Luer-Lock</i>  AT045-022	

## SET AT045-041

Beschreibung <i>Description</i>	Modell <i>Model</i>
Inflow-Spülkanüle, (NL) 70 mm, Ø 4,5 mm, Luer-Lock, mit Hahn <i>Inflow-irrigation cannula, (WL) 70 mm, Ø 4.5 mm, Luer-Lock, with stopcock</i>  AT045-031	
Trokardorn, für Spülkanüle Ø 4,5 mm, mit Luer-Lock <i>Trocar spike, for cannula Ø 4.5 mm, Luer-Lock</i>  AT045-032	
Obturator, für Spülkanüle Ø 4,5 mm, mit Luer-Lock <i>Obturator, for cannula Ø 4.5 mm, Luer-Lock</i>  AT045-033	



Pflegefett für Hähne, 40g  
*Lubricant for stopcocks, 40g*







**RU 8880-50**

# Basis-Set für große Gelenke

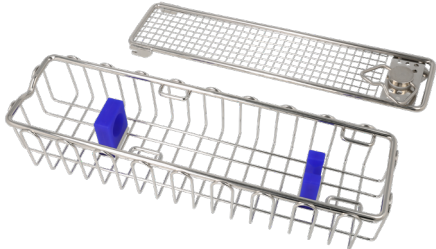
## Basic Set for Big Joints



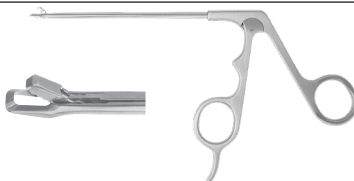
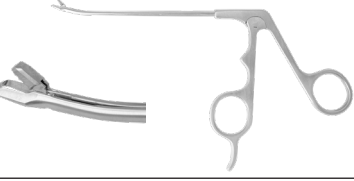

### SET AT040-1000

Artikel Item	Beschreibung Description	Bestell-Nr. Ordering no.
	Arthroskop, autoklavierbar, Ø 4,0mm, 30°, NL 175 mm <i>Arthroscope, autoclavable, Ø 4.0mm, 30°, WL 175mm</i>	<b>AT140-030</b>
	Siebkorb für Endoskop Ø 1,0mm - 5,0mm, 290x80x52 mm (LxBxH) <i>Wire basket for endoscope Ø 1.0mm - 5.0mm, 290x80x52 mm (l x w x h)</i>	<b>RU8908-01</b>
	Schaft mit drehbarem Spülanschluss, 2 Hähne, Ø 5,5mm, 30°, NL 143 mm <i>Sheath with fixed irrigation connection, 2 stopcocks, Ø 5.5mm, 30°, WL 143mm</i>	<b>AT040-102</b>
	Trokar/Obturator, kegelförmig, stumpf, Ø 4,3-4,0mm, NL 175 mm <i>Trocar/Obturator, conical, blunt, Ø 4.3-4.0mm, WL 175mm</i>	<b>AT040-022</b>
	Set Hochleistungslichtleitkabel, inkl. Adapter, Länge 2300 mm, Ø 3,5 mm <i>Set high performance light cable, incl. adapters, length 2300 mm, Ø 3.5 mm</i>	<b>IM201-2311</b>
	Hakensonde, 3,0mm, graduiert <i>Hook probe, 3.0mm, graduated</i>	<b>AT304-027</b>
	RUDOLF ARTHRO-CUT Standard-Korbstanze, gerade <i>RUDOLF ARTHRO-CUT standard basket punch, straight</i>	<b>AT301-001</b>
	RUDOLF ARTHRO-CUT Standard-Korbstanze, aufgebogen <i>RUDOLF ARTHRO-CUT standard basket punch, upswept</i>	<b>AT301-003</b>
	RUDOLF ARTHRO-CUT Alligator-Fasszange, gerade <i>RUDOLF ARTHRO-CUT alligator grasping forceps, straight</i>	<b>AT301-070</b>

# Basis-Set für große Gelenke

## Basic Set for Big Joints

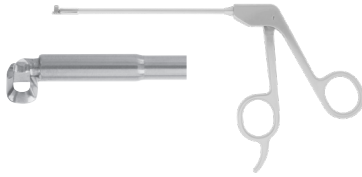
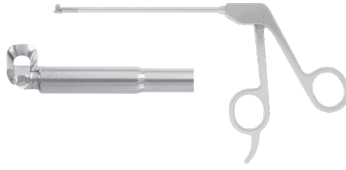

Artikel Item	Beschreibung Description	Bestell-Nr. Ordering no.
	RUDOLF ARTHRO-CUT Korbstanze, 90°, links <i>RUDOLF ARTHRO-CUT basket punch, 90°, left</i>	<b>AT302-092</b>
	RUDOLF ARTHRO-CUT Korbstanze, 90°, rechts <i>RUDOLF ARTHRO-CUT basket punch, 90°, right</i>	<b>AT302-093</b>
	RUDOLF ARTHRO-CUT Slim Line, aufwärts links <i>RUDOLF ARTHRO-CUT Slim Line, upbiter left</i>	<b>AT300-013</b>

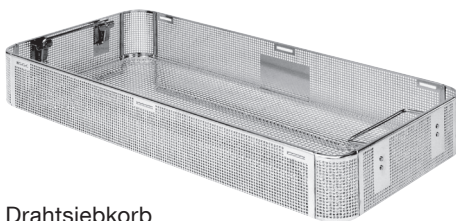

Drahtsiebkorb  
*Wire basket*

480 x 240 x 70 mm

**CS342-070**

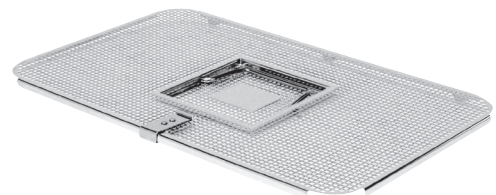

Deckel für Siebkorb  
*Lid for perforated basket*

480 x 240 mm

**CS342-000**



Silikon-Noppenmatte für  
Drahtsiebkorb und Siebkorb  
*Silicone stud mat for  
wire basket and perforated basket*

480 x 220 mm

**CS347-000**



Entsorgungsmarke  
für Drahtsiebkörbe  
*Metal label for  
wire basket*

beschriftet  
*labeled*

**CS961-021**

# Präzision für Perfektionisten: ARTHRO-CUT

## *Precision for Perfectionists: ARTHRO-CUT*



**RUDOLF ARTHRO-CUT** Handinstrumente sind mit zwei unterschiedlichen Griffvarianten erhältlich. Neben dem Standardgriff mit ergonomischen Daumenringen, ist die **ARTHRO-CUT**-Linie auch mit einem speziellen Ring-Branchen-Griff verfügbar. Diese Griffform überzeugt durch eine verbesserte Kraftübertragung und sorgt für einen leichteren Schnitt auch bei groben Knorpelstrukturen.

**RUDOLF ARTHRO-CUT** hand instruments are available with two different handle designs. In addition to the standard handle with ergonomic thumb rings, the **ARTHRO-CUT** line is also available with a special ring-branch handle. This handle form impresses with improved force transmission and ensures an easier cut even with thick cartilage structures.

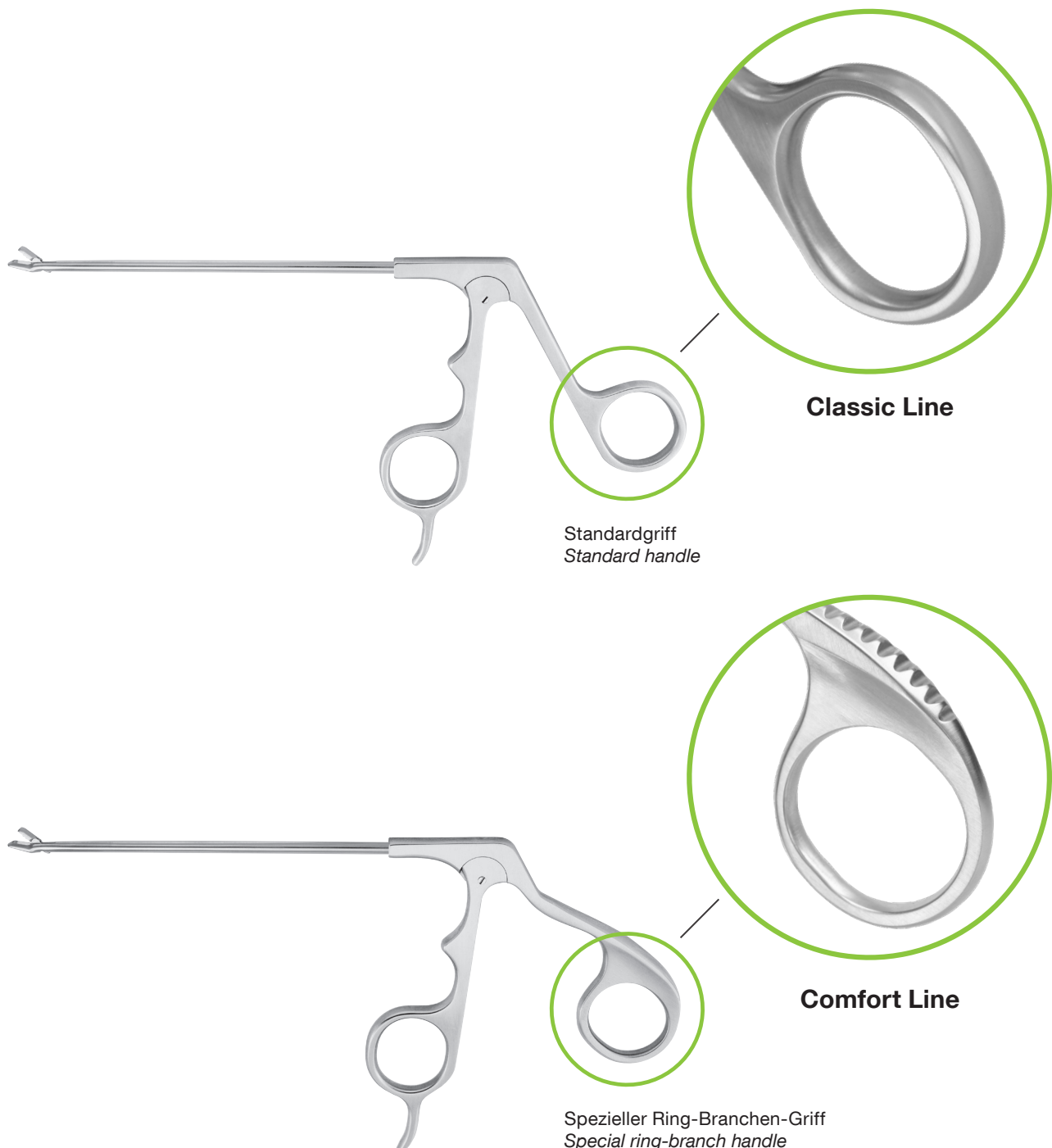



Auch die Maulteile der **ARTHRO-CUT**- Stanzen sind in den unterschiedlichen Ausführungen standard, slim und narrow erhältlich, so ist ein präzises Arbeiten in unterschiedlichen OP-Situationen möglich.

*The jaws of the **ARTHRO-CUT** punches are also available in standard, slim and narrow designs, enabling precise work under different surgical conditions.*

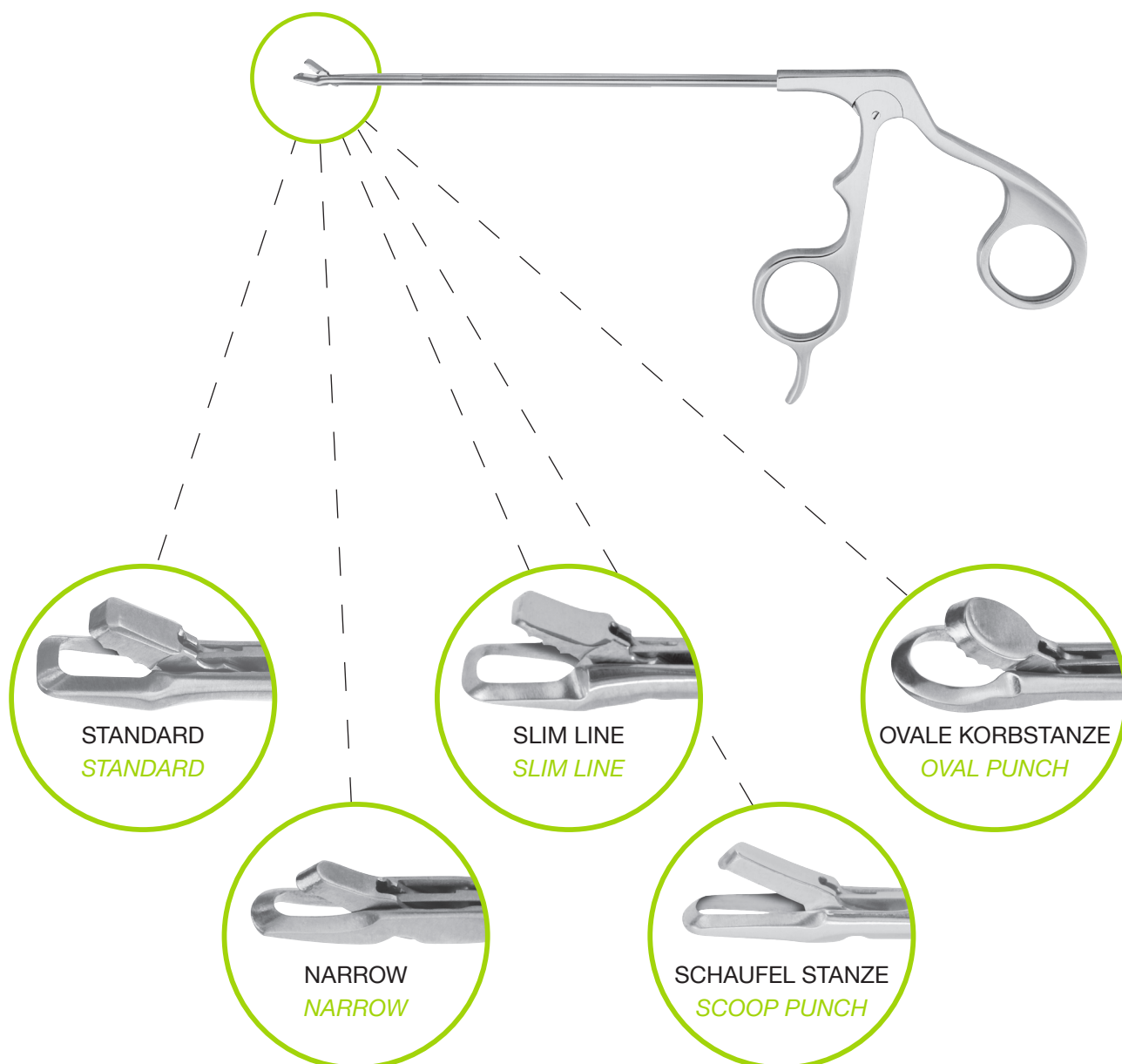





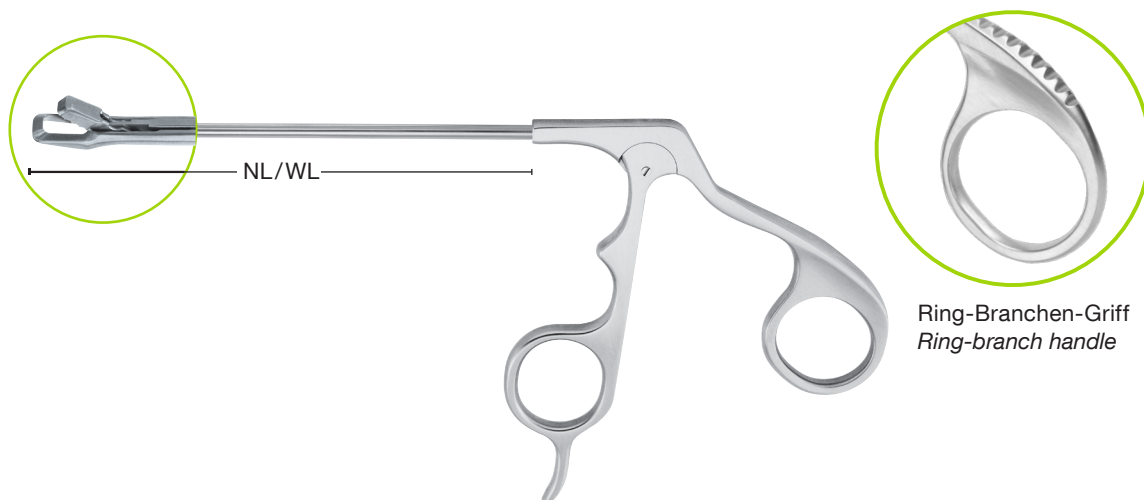

# ARTHRO-CUT Comfort Line – Standard

## ARTHRO-CUT Comfort Line – Standard



### Stanze Standard

### Punch Standard

Modell Model	Schnittbreite Cutting width	Maulteilunterseite (Höhe) Lower jaw (height)	Maulteil (Gesamthöhe) Jaw (total height)	Nutzlänge (NL) Working length (WL)	Bestell-Nr. Ordering no.
 gerade straight	3.2 mm	1.5 mm	2.0 mm	120 mm – 4¾"	<b>AT300-001</b>
 aufwärts upbiter					<b>AT300-002</b>
 aufwärts, links gebogen upbiter, left curved	3.2 mm	1.5 mm	2.0 mm	120 mm – 4¾"	<b>AT300-004</b>
 aufwärts, rechts gebogen upbiter, right curved					<b>AT300-005</b>
 gerade, links gebogen straight, left curved	3.2 mm	1.5 mm	2.0 mm	120 mm – 4¾"	<b>AT300-006</b>
 gerade, rechts gebogen straight, right curved					<b>AT300-007</b>





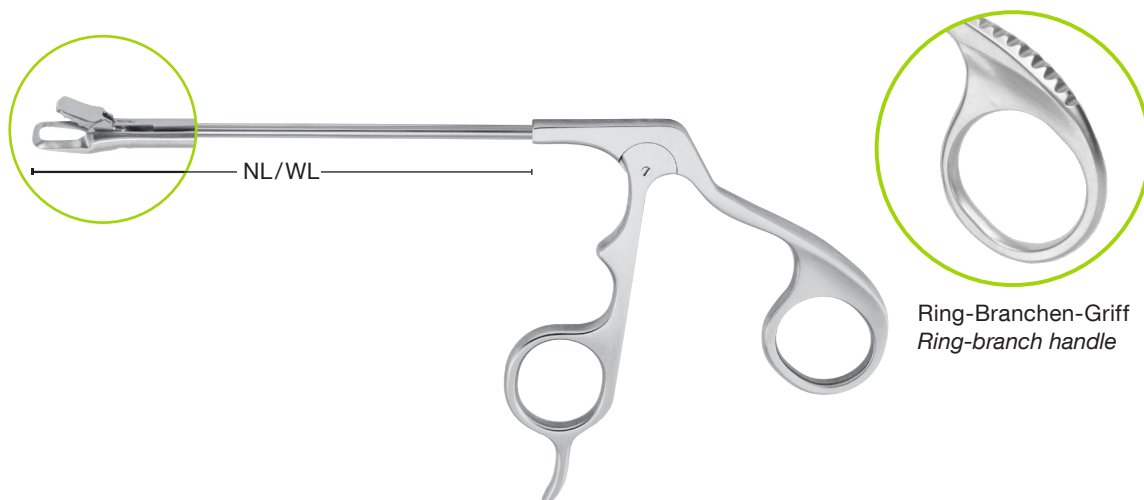

# ARTHRO-CUT Comfort Line – Slim

## ARTHRO-CUT Comfort Line – Slim



Ring-Branchen-Griff  
Ring-branch handle

### Stanze Slim Punch Slim

Modell Model	Schnittbreite Cutting width	Maulteilunterseite (Höhe) Lower jaw (height)	Maulteil (Gesamthöhe) Jaw (total height)	Nutzlänge (NL) Working length (WL)	Bestell-Nr. Ordering no.
 gerade straight	3.2 mm	1.5 mm	2.0 mm	120 mm – 4¾"	<b>AT300-010</b>
 aufwärts upbiter					<b>AT300-011</b>
 aufwärts, links gebogen upbiter, left curved	3.2 mm	1.5 mm	2.0 mm	120 mm – 4¾"	<b>AT300-013</b>
 aufwärts, rechts gebogen upbiter, right curved					<b>AT300-014</b>
 gerade, links gebogen straight, left curved	3.2 mm	1.5 mm	2.0 mm	120 mm – 4¾"	<b>AT300-015</b>
 gerade, rechts gebogen straight, right curved					<b>AT300-016</b>

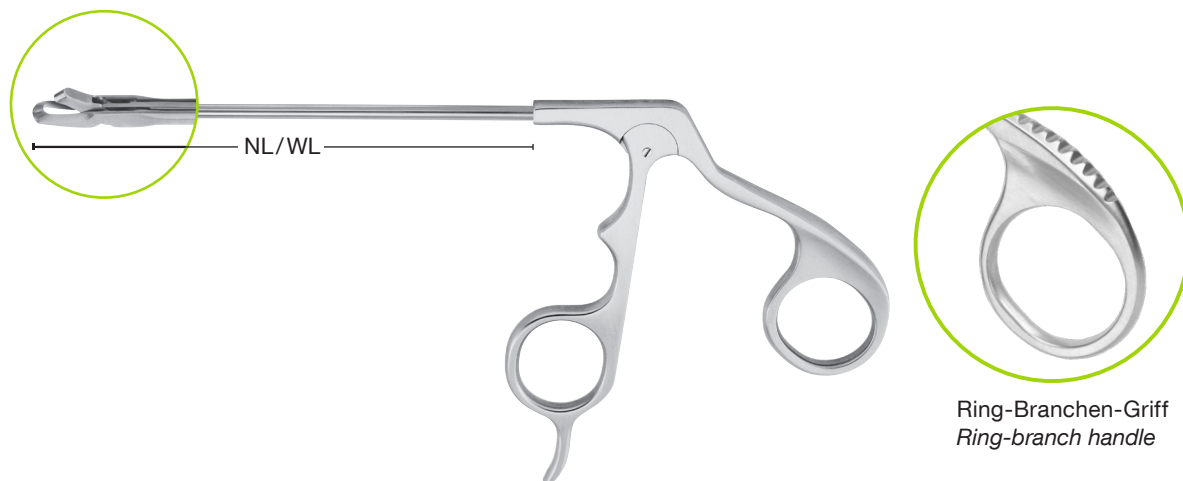

# ARTHRO-CUT Comfort Line – Narrow

## ARTHRO-CUT Comfort Line – Narrow



Ring-Branchen-Griff  
Ring-branch handle

### Stanze Narrow Punch Narrow

Modell Model	Schnittbreite Cutting width	Maulteilunterseite (Höhe) Lower jaw (height)	Maulteil (Gesamthöhe) Jaw (total height)	Nutzlänge (NL) Working length (WL)	Bestell-Nr. Ordering no.
 gerade straight	2.2 mm	1.5 mm	2.0 mm	120 mm – 4¾"	<b>AT300-020</b>
 aufwärts upbiter					<b>AT300-021</b>

# ARTHRO-CUT Comfort Line – Schaufel Stanze

## ARTHRO-CUT Comfort Line – Scoop Punch

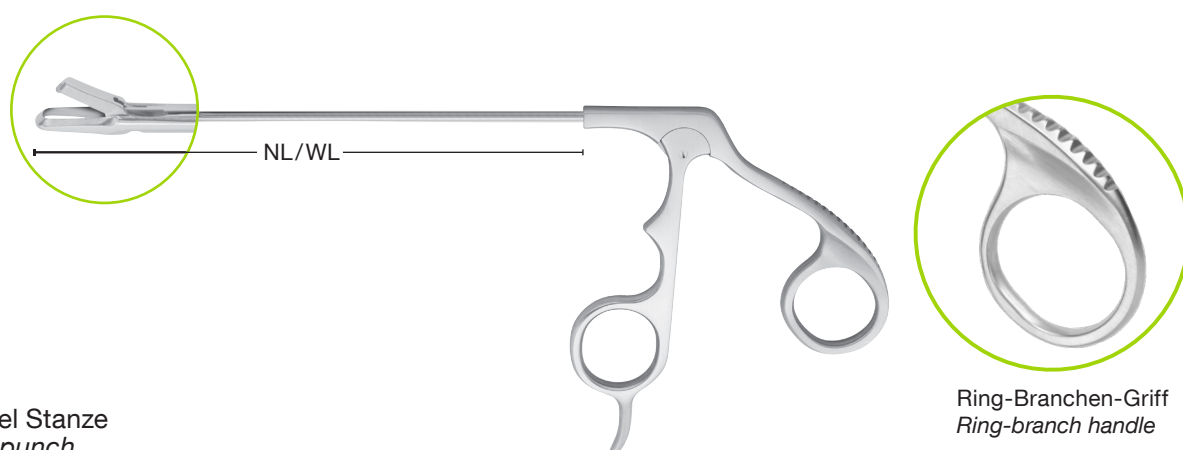

Ring-Branchen-Griff  
Ring-branch handle

### Schaufel Stanze Scoop punch

Modell Model	Schnittbreite Cutting width	Maulteilunterseite (Höhe) Lower jaw (height)	Maulteil (Gesamthöhe) Jaw (total height)	Nutzlänge (NL) Working length (WL)	Bestell-Nr. Ordering no.
 gerade straight	2.0 mm	1.5 mm	2.0 mm	120 mm – 4¾"	<b>AT300-040</b>





# ARTHRO-CUT Comfort Line – Ovale Korbstanzen

## ARTHRO-CUT Comfort Line – Oval Punches



### Ovale Korbstanze



#### Oval punch

Modell Model	Schnittbreite Cutting width	Maulteilunterseite (Höhe) Lower jaw (height)	Maulteil (Gesamthöhe) Jaw (total height)	Nutzlänge (NL) Working length (WL)	Bestell-Nr. Ordering no.
 gerade straight	4.5 mm	1.5 mm	2.0 mm	120 mm – 4¾"	<b>AT300-030</b>
 aufwärts upbiter	4.5 mm	1.5 mm	2.0 mm	120 mm – 4¾"	<b>AT300-031</b>

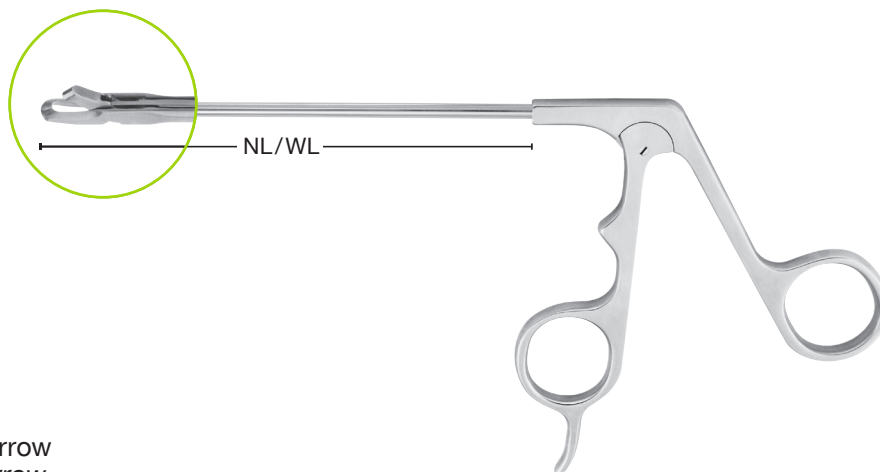
ARTHRO-CUT Classic Line – Narrow  
*ARTHRO-CUT Classic Line – Narrow*



Stanze Narrow  
 Punch Narrow

Modell Model	Schnittbreite Cutting width	Maulteilunterseite (Höhe) Lower jaw (height)	Maulteil (Gesamthöhe) Jaw (total height)	Nutzlänge (NL) Working length (WL)	Bestell-Nr. Ordering no.
 gerade straight	2.2 mm	1.5 mm	2.0 mm	120 mm – 4¾"	<b>AT301-020</b>
 aufwärts upbiter					<b>AT301-021</b>

ARTHRO-CUT Classic Line – Schaufel Stanze  
*ARTHRO-CUT Classic Line – Scoop Punch*

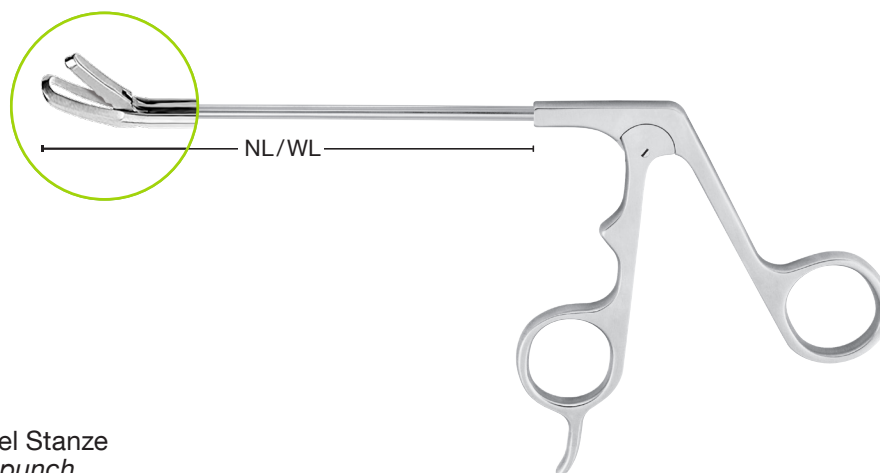

Schaufel Stanze  
 Scoop punch





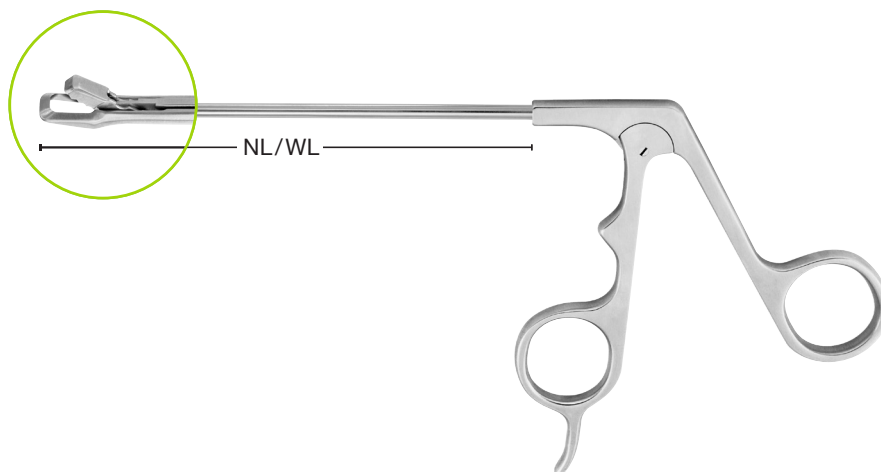

Modell Model	Schnittbreite Cutting width	Maulteilunterseite (Höhe) Lower jaw (height)	Maulteil (Gesamthöhe) Jaw (total height)	Nutzlänge (NL) Working length (WL)	Bestell-Nr. Ordering no.
 aufwärts upbiter	2.0 mm	1.5 mm	2.0 mm	120 mm – 4¾"	<b>AT301-051</b>

# ARTHRO-CUT Classic Line – Standard Korbstanzen

## ARTHRO-CUT Classic Line – Standard Punches



### Korbstanze Standard Punch Standard





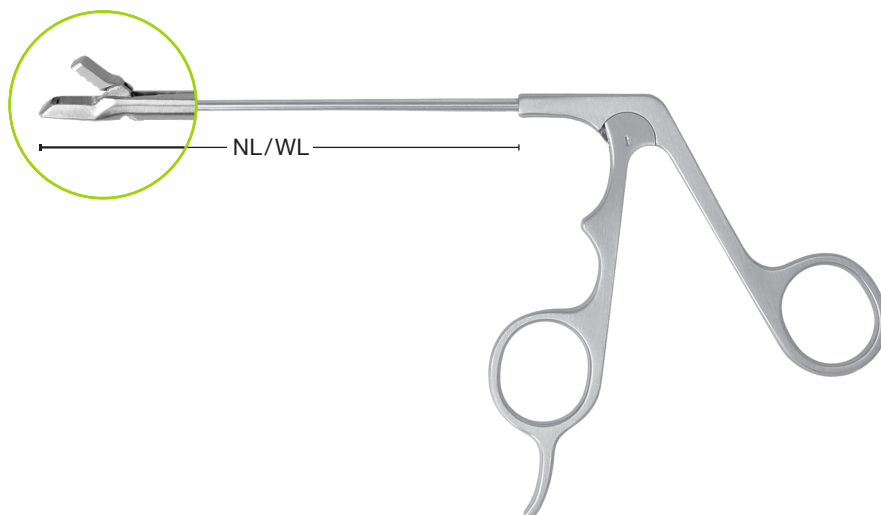

Modell Model	Schnittbreite Cutting width	Maulteilunterseite (Höhe) Lower jaw (height)	Maulteil (Gesamthöhe) Jaw (total height)	Nutzlänge (NL) Working length (WL)	Bestell-Nr. Ordering no.
 gerade straight	3.2 mm	1.5 mm	2.0 mm	120 mm – 4¾"	AT301-001
 aufwärts upbiter					AT301-002
 aufgebogen upswept					AT301-003
 aufwärts, links gebogen upbiter, left curved	3.2 mm	1.5 mm	2.0 mm	120 mm – 4¾"	AT301-004
 aufwärts, rechts gebogen upbiter, right curved					AT301-005
 gerade, links gebogen straight, left curved	3.2 mm	1.5 mm	2.0 mm	120 mm – 4¾"	AT301-006
 gerade, rechts gebogen straight, right curved					AT301-007

# ARTHRO-CUT Classic Line – Slim Korbstanze

## ARTHRO-CUT Classic Line – Slim Punch



### Korbstanze Slim Punch Slim



Modell Model	Schnittbreite Cutting width	Maulteilunterseite (Höhe) Lower jaw (height)	Maulteil (Gesamthöhe) Jaw (total height)	Nutzlänge (NL) Working length (WL)	Bestell-Nr. Ordering no.
 gerade straight	3.2 mm	1.5 mm	2.0 mm	120 mm – 4¾"	<b>AT301-010</b>
 aufwärts upbiter					<b>AT301-011</b>
 aufgebogen upswept					<b>AT301-012</b>
 aufwärts, links gebogen upbiter, left curved	3.2 mm	1.5 mm	2.0 mm	120 mm – 4¾"	<b>AT301-013</b>
 aufwärts, rechts gebogen upbiter, right curved					<b>AT301-014</b>
 gerade, links gebogen straight, left curved	3.2 mm	1.5 mm	2.0 mm	120 mm – 4¾"	<b>AT301-015</b>
 gerade, rechts gebogen straight, right curved					<b>AT301-016</b>

# ARTHRO-CUT Classic Line – Ovale Korbstanzen

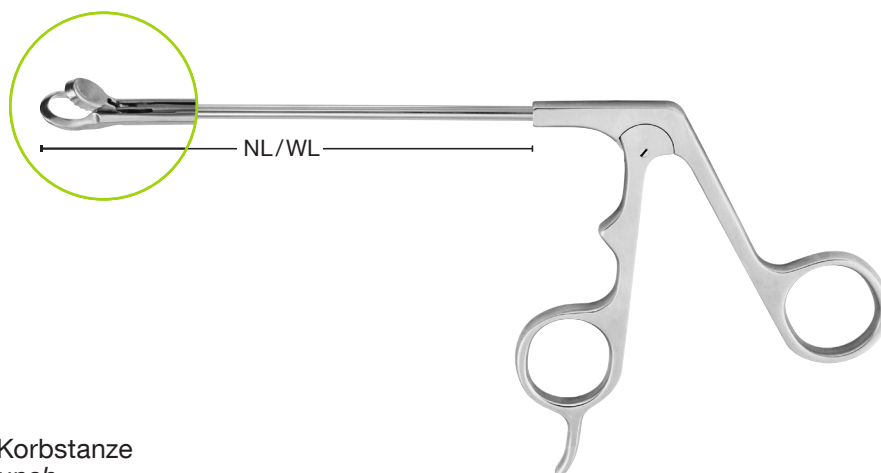
## ARTHRO-CUT Classic Line – Oval Punches



Ovale Korbstanze  
Oval punch



Modell Model	Schnittbreite Cutting width	Maulteilunterseite (Höhe) Lower jaw (height)	Maulteil (Gesamthöhe) Jaw (total height)	Nutzlänge (NL) Working length (WL)	Bestell-Nr. Ordering no.
 gerade straight	4.5 mm	1.5 mm	2.0 mm	120 mm – 4¾"	<b>AT301-030</b>
 aufwärts upbiter	4.5 mm	1.5 mm	2.0 mm	120 mm – 4¾"	<b>AT301-031</b>

# ARTHRO-CUT Classic Line – Retrograde Stanzen

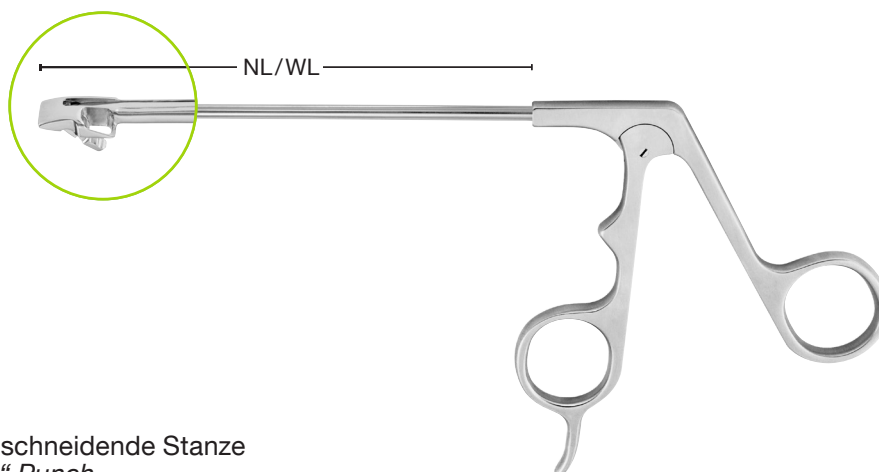
## ARTHRO-CUT Classic Line – Backbiter Punches



Retrograd schneidende Stanze  
„Backbiter“ Punch

Modell Model	Maulteil (Gesamthöhe), 2,3 mm Jaw (total height), 2.3 mm	Nutzlänge (NL) Working length (WL)	Bestell-Nr. Ordering no.
 links left	2.3 mm	120 mm – 4¾"	<b>AT301-080</b>
 rechts right	2.3 mm	120 mm – 4¾"	<b>AT301-081</b>

ARTHRO-CUT Classic Line – Scheren Stanze  
*ARTHRO-CUT Classic Line – Scissors Punch*

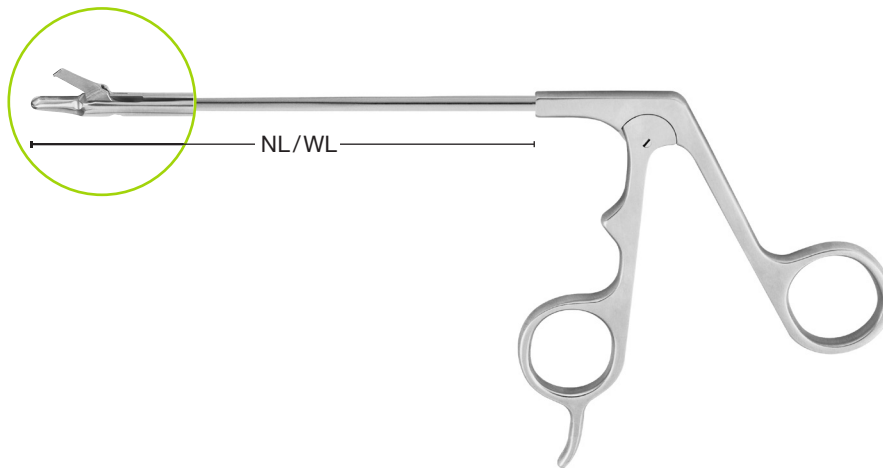



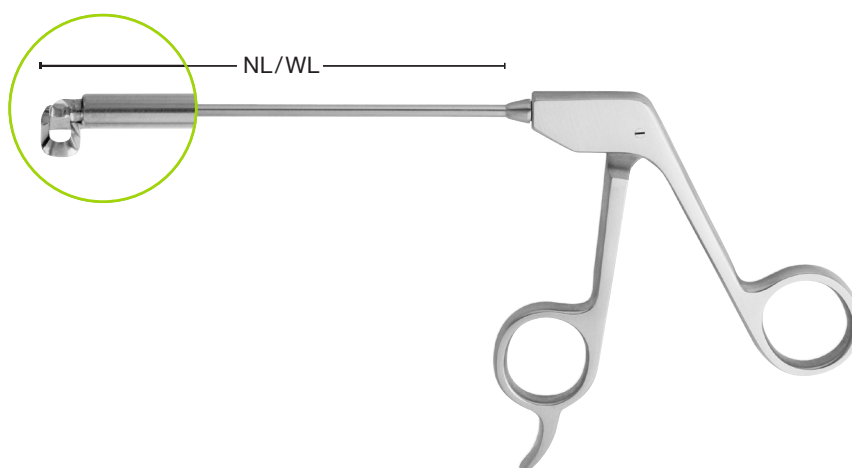

Scheren Stanze  
*Scissors punch*

Modell <i>Model</i>	Schnittbreite <i>Cutting width</i>	Maulteilunterseite (Höhe) <i>Lower jaw (height)</i>	Maulteil (Gesamthöhe) <i>Jaw (total height)</i>	Nutzlänge (NL) <i>Working length (WL)</i>	Bestell-Nr. <i>Ordering no.</i>
 gerade <i>straigh</i>	0.8 mm	1.5 mm	2.0 mm	120 mm – 4¾"	<b>AT301-060</b>

ARTHRO-CUT Classic Line – Korbstanzen 90°  
*ARTHRO-CUT Classic Line – Basket Punches 90°*



Korbstanze 90°  
*Basket Punch 90°*

Modell <i>Model</i>	Maulteil (Gesamthöhe) <i>Jaw (total height)</i>	Nutzlänge (NL) <i>Working length (WL)</i>	Bestell-Nr. <i>Ordering no.</i>
 links <i>left</i>	2.2 mm	120 mm – 4¾"	<b>AT302-090</b>
 rechts <i>right</i>	2.2 mm	120 mm – 4¾"	<b>AT302-091</b>
 links <i>left</i>	3.4 mm	120 mm – 4¾"	<b>AT302-092</b>
 rechts <i>right</i>	3.4 mm	120 mm – 4¾"	<b>AT302-093</b>

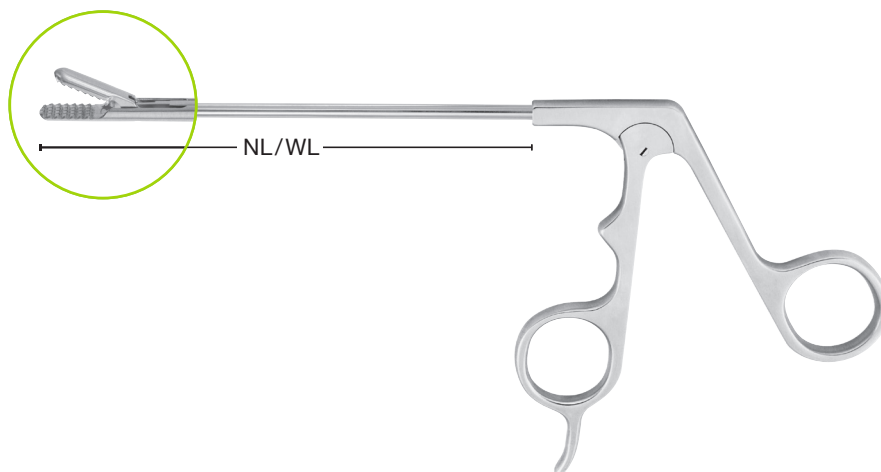

# Fasszangen

## Grasping Forceps



### Alligator Fasszange

#### Alligator grasping forceps

Modell Model	Maulteil (Gesamthöhe) Jaw (total height)	Nutzlänge (NL) Working length (WL)	Bestell-Nr. Ordering no.
 gerade straight	3.2 mm	120 mm – 4¾"	<b>AT301-070</b>
 gerade straight	2.7 mm	120 mm – 4¾"	<b>AT301-071</b>

### Super Fasszange

#### Super grasping forceps

Modell Model	Maulteil (Gesamthöhe) Jaw (total height)	Nutzlänge (NL) Working length (WL)	Bestell-Nr. Ordering no.
 gerade straight	3.2 mm	120 mm – 4¾"	<b>AT301-072</b>

### Fasszange

#### Grasping forceps

Modell Model	Maulteil (Gesamthöhe) Jaw (total height)	Nutzlänge (NL) Working length (WL)	Bestell-Nr. Ordering no.
 gerade straight	2.7 mm	120 mm – 4¾"	<b>AT301-073</b>





Meniskus Fasszange mit Feststellschraube  
*Meniscus Grasping Forceps with Locking Screw*

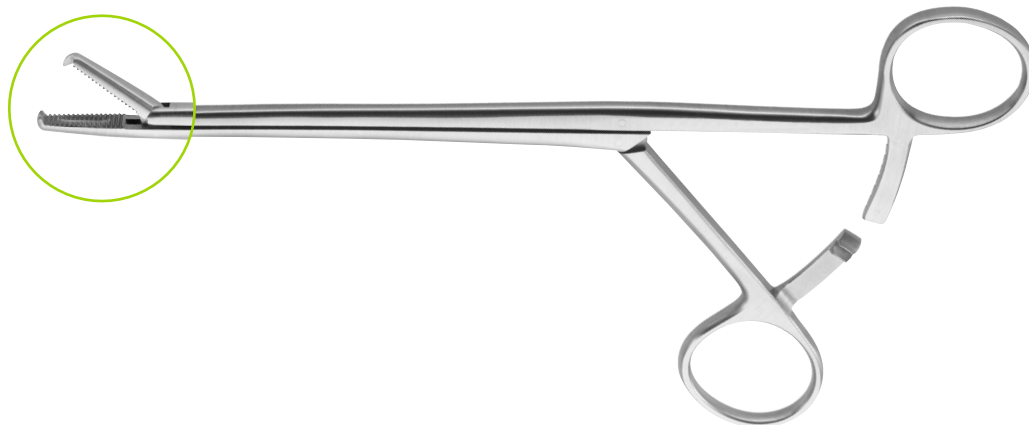

Modell Model	Beschreibung Description	Länge Working length	Bestell-Nr. Ordering no.
	Meniskus Fasszange mit Komfortgriff, Feststellschraube, 1x2 Zähne, gezahnt <i>Meniscus grasping forceps with comfort handle, locking screw, 1x2 teeth, serrated</i>	170 mm – 6¾"	<b>AT303-020</b>

Meniskus Fasszange mit Sperre  
*Meniscus Grasping Forceps with Ratchet*





Modell Model	Beschreibung Description	Länge Working length	Bestell-Nr. Ordering no.
	Meniskus Fasszange mit Sperre, gerade, gezahnt <i>Meniscus grasping forceps with ratchet, straight, serrated jaw</i>	100 mm – 4"	<b>AT302-020</b>

# Mikrofraktor und Raspeln

## *Microfractor and Rasps*



Mikrofraktor, Schaft Ø 4,0 mm  
*Microfractor, shaft Ø 4.0 mm*

Modell <i>Model</i>	Blickrichtung <i>Direction of view</i>	Nutzlänge (NL) <i>Working length (WL)</i>	Bestell-Nr. <i>Ordering no.</i>
	30°	175 mm – 7"	<b>AT304-001</b>
	45°	175 mm – 7"	<b>AT304-002</b>
	60°	175 mm – 7"	<b>AT304-003</b>



Raspel, grob, Schaft Ø 4,0 mm  
*Rasp, rough, shaft Ø 4.0 mm*

Modell <i>Model</i>	Blickrichtung <i>Direction of view</i>	Nutzlänge (NL) <i>Working length (WL)</i>	Bestell-Nr. <i>Ordering no.</i>
	gerade <i>straight</i>	120 mm – 4¾"	<b>AT304-004</b>

# Arthroskopie-Instrumente mit festem Handgriff

## Arthroscopy Instruments with Fixed Handle





Modell Model	Beschreibung Description	Bestell-Nr. Ordering no.
	Skalpellmesser Scalpel Knife	<b>AT304-011</b>
	Retrograd Messer, 45° Retrograde Knife, 45°	<b>AT304-012</b>
	Bananenmesser, gezahnt Banana knife, serrated	<b>AT304-014</b>
	Hakenmesser, 3 mm Hook knife, 3 mm	<b>AT304-015</b>
	Bajonettmesser Bayonet knife	<b>AT304-019</b>
	Sichelmesser Sickle knife	<b>AT304-020</b>
	Smillie Meniskotom, 3 mm Smillie meniscotome, 3 mm	<b>AT304-021</b>
	Ring-Kürette, Ø 3 mm Ring curette, Ø 3 mm	<b>AT304-024</b>
	Ring-Kürette, Ø 7 mm Ring curette, Ø 7 mm	<b>AT304-025</b>
	Löffel, Ø 3 mm, 30° gebogen Spoon, Ø 3 mm, 30° curved	<b>AT304-026</b>
	Hakensonde, Ø 3 mm, graduiert Hook probe, Ø 3 mm, graduated	<b>AT304-027</b>
	Hakensonde, Ø 5 mm, graduiert Hook probe, Ø 5 mm, graduated	<b>AT304-028</b>
	Hakensonde, spitz Hook probe, pointed	<b>AT304-029</b>

# Arthroskopie-Instrumente mit abnehmbaren Universalhandgriff

## Arthroscopy Instruments with Removable Universal Handle





Komplett mit Griff, Schaft Ø 3 mm  
Complete with handle, shaft Ø 3 mm

Modell Model	Beschreibung Description	Bestell-Nr. Ordering no.
	Ring-Kürette, Ø 3 mm Ring curette, Ø 3 mm	<b>AT304-214</b>
	Löffel, Ø 3 mm, 30° gebogen Spoon, Ø 3 mm, 30° curved	<b>AT304-216</b>
	Hakensonde, Ø 3 mm, graduiert Hook probe, Ø 3 mm, graduated	<b>AT304-217</b>



Aufsatz, allein, Schaft Ø 3 mm  
Tip, only, shaft Ø 3 mm

Modell Model	Beschreibung Description	Bestell-Nr. Ordering no.
	Ring-Kürette, Ø 3 mm Ring curette, Ø 3 mm	<b>AT304-114</b>
	Löffel, Ø 3 mm, 30° gebogen Spoon, Ø 3 mm, 30° curved	<b>AT304-116</b>
	Hakensonde, Ø 3 mm, graduiert Hook probe, Ø 3 mm, graduated	<b>AT304-117</b>

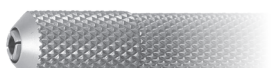

Griff, einzeln, für Aufsätze mit Schaft Ø 3 mm  
Handle, only, for tips with shaft Ø 3 mm

Modell Model	Beschreibung Description	Bestell-Nr. Ordering no.
	Griff Handle	<b>AT304-200</b>

Bipolare HF-Elektroden, wiederverwendbar  
*Bipolar HF Electrodes, reusable*

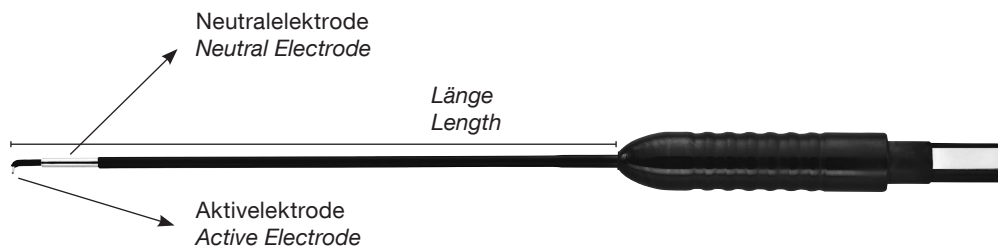







Modell Model	Beschreibung Description	Länge Length	Bestell-Nr. Ordering no.
	Bipolare Hakenelektrode, 1,5x0,6 mm <i>Bipolar hook electrode, 1.5x0.6 mm</i>	115 mm – 4½"	<b>AT450-001</b>
	Bipolare Hakenelektrode, 4,0x0,6 mm <i>Bipolar hook electrode, 4.0x0.6 mm</i>	115 mm – 4½"	<b>AT450-002</b>
	Bipolare Elektrode „Booster“ <i>Bipolar electrode „Booster“</i>	115 mm – 4½"	<b>AT450-006</b>

# Kabel für bipolare Instrumente

## Cable for bipolar instruments

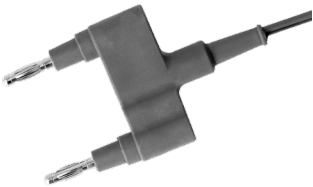

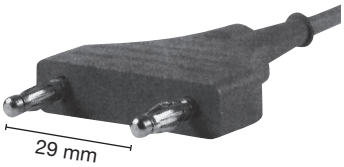
	Flachstecker <i>Flat plug</i>		2-Pin Stecker US-Standard <i>2-pin plug US-Standard</i>	
				
	Instrumentenseite <i>Instrument side</i>			
Geräteseite <i>Generator side</i>	Länge <i>Length</i>		Länge <i>Length</i>	
 Steg biegsam / <i>flexible joint</i>	4 m	HF310-104	4 m	HF310-3031
 Erbe	3 m	HF310-113	–	–
 Martin, Berchtold, Aesculap	3 m	HF310-123	–	–
	5 m	HF310-125	–	–
 Valleylab, Lamidey, EMC 29 mm	3 m	HF310-133	3 m	HF310-333
	5 m	HF310-135	–	–

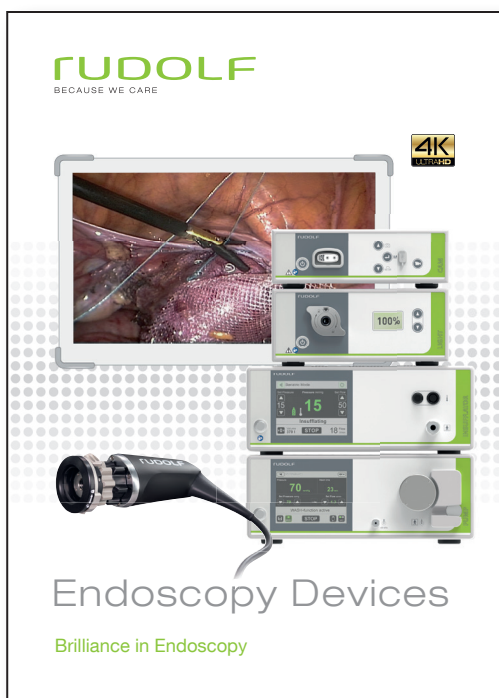

Informationen zu Endoskopiegeräten ZK 583-02  
*Information on endoscopy devices ZK 583-02*



RUDOLF Medical GmbH + Co. KG, weltweit vertreten, vertraut auf bleibende Werte und setzt diese durch enge Kundenbeziehungen um. RUDOLF Medical bietet innovative Hightech-Produkte, Handinstrumente, starre Endoskope sowie effiziente Serviceleistungen für zahlreiche chirurgische Fachgebiete an.

*RUDOLF Medical GmbH + Co. KG, represented worldwide, translates its belief in lasting values by fostering close customer relationships and offering innovative high technology products, hand instruments, rigid endoscopes as well as efficient services for numerous surgical disciplines.*

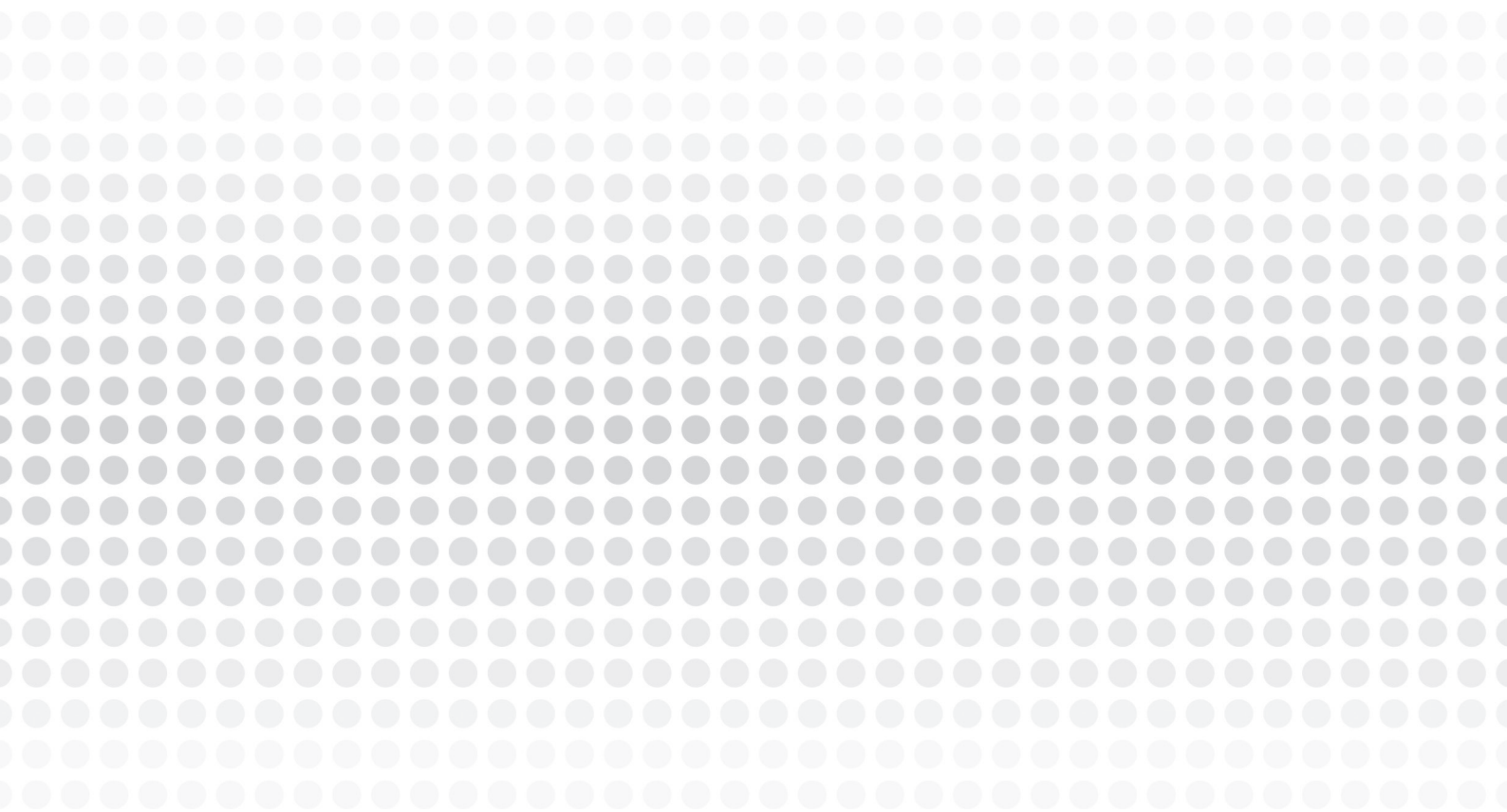

# RUDOLF

**RUDOLF** Medical GmbH + Co. KG  
Zollerstr. 1, 78567 Fridingen, Germany  
Tel. +49 7463 9956-0  
sales@rudolf-med.com  
www.rudolf-med.com

Vertrieb durch:  
Distributed by:



**MITTELSTAND  
GLOBAL**  
HEALTH MADE  
IN GERMANY