

RUDOLF

BECAUSE WE CARE



ENT

EAR, NOSE & THROAT

INHALTSVERZEICHNIS

CONTENTS

Kapitel 1 – 12

Chapter 1 – 12

1	Endoskope, Kaltlichtkabel	<i>Endoscopes, Cold Light Cables</i>	1
2	Hochfrequenz-Chirurgie	<i>High-Frequency Surgery</i>	2
3	Allgemeines Instrumentarium	<i>General Surgical Instruments</i>	3
4	Otologie und Ohr-Mikroinstrumente	<i>Otology and Ear Microsurgery Instruments</i>	4
5	Rhinologie und Rhinoplastik	<i>Rhinology and Rhinoplasty</i>	5
6	Adenotomie und Tonsillektomie	<i>Adenoidectomy and Tonsillectomy</i>	6
7	Sinuskopie	<i>Sinuscopy</i>	7
8	Tracheotomie	<i>Tracheotomy</i>	8
9	Endolaryngeale Mikrochirurgie	<i>Endolaryngeal Microsurgery</i>	9
10	Bronchoskopie und Oesophagoskopie	<i>Bronchoscopy and Oesophagoscopy</i>	10
11	Reinigung, Pflege und Sterilisation	<i>Cleaning, Care and Sterilization</i>	11
12	Nummernindex	<i>Numerical Index</i>	12

KAPITEL I – Endoskope, Kaltlichtkabel
CHAPTER I – Endoscopes, Cold Light Cables



Seite / Page

Endoskope	<i>Endoscopes</i>	5
Kaltlichtkabel - HTT	<i>Cold Light Cable - HTT</i>	6
Adapter für Kaltlichtkabel	<i>Fittings For Cold Light Cabels</i>	7



2,7

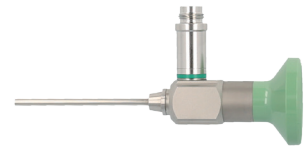

Bestell Nr. Ordering no.	Durchmesser Diameter	Blickrichtung View direction	Arbeitslänge Working length	Erkennungsfarbe Identification colour
EN127-000	2.7 mm	0° Otoscope	50 mm	grün / green
EN127-030	2.7 mm	30° Otoscope	50 mm	rot / red

4

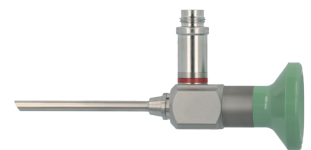

Bestell Nr. Ordering no.	Durchmesser Diameter	Blickrichtung View direction	Arbeitslänge Working length	Erkennungsfarbe Identification colour
EN140-100	4 mm	0° Otoscope	50 mm	grün / green
EN140-130	4 mm	30° Otoscope	50 mm	rot / red

2,7



Bestell Nr. Ordering no.	Durchmesser Diameter	Blickrichtung View direction	Arbeitslänge Working length	Erkennungsfarbe Identification colour
EN127-100	2.7 mm	0° Sinuscope	175 mm	grün / green
EN127-130	2.7 mm	30° Sinuscope	175 mm	rot / red
EN127-170	2.7 mm	70° Sinuscope	175 mm	gelb / yellow

4



Bestell Nr. Ordering no.	Durchmesser Diameter	Blickrichtung View direction	Arbeitslänge Working length	Erkennungsfarbe Identification colour
EN140-000	4 mm	0° Sinuscope	175 mm	grün / green
EN140-030	4 mm	30° Sinuscope	175 mm	rot / red
EN140-045	4 mm	45° Sinuscope	175 mm	schwarz / black
EN140-070	4 mm	70° Sinuscope	175 mm	gelb / yellow

Kaltlichtkabel - HTT - Kabel

Cold light cable - HTT-cables



20% mehr Lichtdurchlässigkeit
als bei Standardkabeln

20% more light transmission
than with standard cables



HTT

High Transmission Technology
High Transmission Technology

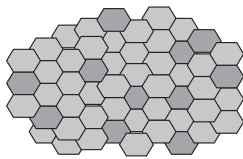

Für Endoskope < Ø 5 mm → Lichtkabel Ø 3,5 mm
For endoscope < Ø 5 mm → light cable Ø 3.5 mm

Länge Length	Durchmesser Diameter	Bestell Nr. Ordering no.	Set Bestell Nr. Ordering Set no.
1.8 m	Ø 3.5 mm	IM201-181	IM201-1811
2.3 m	Ø 3.5 mm	IM201-231	IM201-2311
3.0 m	Ø 3.5 mm	IM201-301	IM201-3011
3.5 m	Ø 3.5 mm	IM201-351	IM201-3511

ohne Adapter
without fittings

inkl. RUDOLF / Storz Anschluss IM220-020 + IM220-040
(Endoskop- und Lichtquellenseite)
incl. RUDOLF / Storz fitting IM220-020 + IM220-040
(Endoscope and light source side)



Weitere Geräte finden Sie in ZK 583-02 Endoskopiegeräte
More units can be found in ZK 583-02 Endoscopy Devices

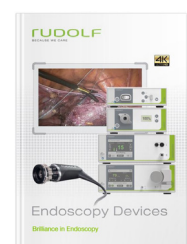

Adapter für Kaltlichtkabel Fittings for cold light cables

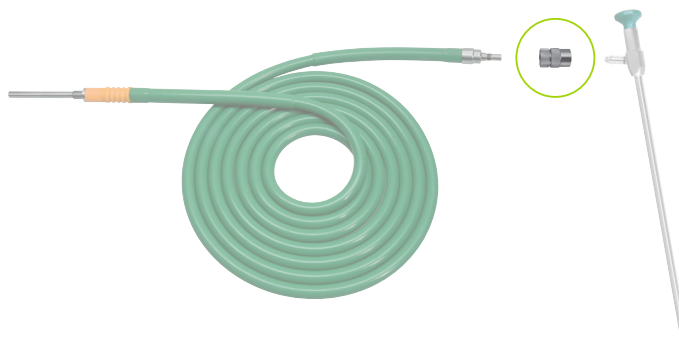

Adapter Endoskopseite (Lichtausgang) Adapter Endoscope Side (Light Output)	Verbindung Connection	Bestell Nr. Ordering no.
RUDOLF / Storz		IM220-020
Wolf (Snap-In)		IM220-021
ACMI (Snap-In)		IM220-022
Stryker		IM220-025

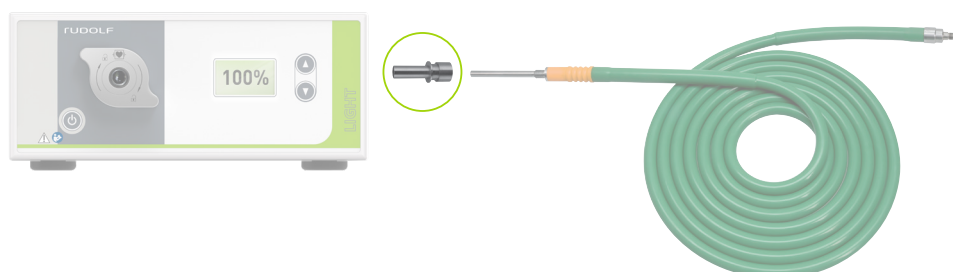

Adapter Lichtquellenseite (Lichteingang) Adapter Light Source Side (Light Input)	Verbindung Connection	Bestell Nr. Ordering no.
RUDOLF / Storz		IM220-040
Wolf		IM220-041
ACMI / Stryker		IM220-042
Olympus		IM220-043



HF-Handgriffe	<i>HF-Handles</i>	11 - 12
Monopolare Elektroden	<i>Monopolar Electrodes</i>	13
Bipolare Scheren	<i>Bipolar Scissors</i>	14 - 15
Bipolare Pinzetten	<i>Bipolar Forceps</i>	16 - 25
Bipolare Anschlusskabel	<i>Bipolar Connecting Cables</i>	26

HF-Handgriffe HF-Handles



zur Verwendung mit Elektroden Ø 2,4 mm und 6-kant Schaft
to be used with electrodes Ø 2.4 mm and 6-edge shaft



max. Spannung: 4,3 kVp
max. voltage: 4.3 kVp

Anschluss Geräteseite
Connection equipment side

Ø 2,4 mm 

HF-Handgriff evoline für Erbe HF-Handle evoline for Erbe

mit integriertem Kabel
with integrated cable
mit 2 Tasten
with 2 buttons

Länge / Length
4 m

HF410-026



max. Spannung: 4,3 kVp
max. voltage: 4.3 kVp

Anschluss Geräteseite
Connection equipment side

Ø 2,4 mm 



HF-Handgriff evoline für Martin HF-Handle evoline for Martin

mit integriertem Kabel
with integrated cable
mit 2 Tasten
with 2 buttons

Länge / Length
4 m

HF410-028



max. Spannung: 4,3 kVp
max. voltage: 4.3 kVp

Anschluss Geräteseite
Connection equipment side

Ø 2,4 mm 



HF-Handgriff evoline für Modelle mit internationalem Anschluss 3-polig HF-Handle evoline for models with international connection plug 3 pin

mit integriertem Kabel
with integrated cable
mit 2 Tasten
with 2 buttons

Länge / Length
4 m

HF410-030

HF-Handgriffe

HF-Handles



zur Verwendung mit Elektroden Ø 4 mm und 6-kant Schaft
to be used with electrodes Ø 4 mm and 6-edge shaft



max. Spannung: 4,3 kVp
max. voltage: 4.3 kVp

Anschluss Geräteseite
Connection equipment side

Ø 4 mm



HF-Handgriff evoline für Erbe **HF-Handle evoline** *for Erbe*

mit integriertem Kabel
with integrated cable
mit 2 Tasten
with 2 buttons

Länge / Length
4 m

HF410-020



max. Spannung: 4,3 kVp
max. voltage: 4.3 kVp

Anschluss Geräteseite
Connection equipment side

Ø 4 mm



HF-Handgriff evoline für Martin **HF-Handle evoline** *for Martin*

mit integriertem Kabel
with integrated cable
mit 2 Tasten
with 2 buttons

Länge / Length
3 m

HF410-022



max. Spannung: 4,3 kVp
max. voltage: 4.3 kVp

Anschluss Geräteseite
Connection equipment side

Ø 4 mm



HF-Handgriff evoline für Modelle mit internationalem Anschluss 3-polig **HF-Handle evoline** *for models with international connection plug 3 pin*

mit integriertem Kabel
with integrated cable
mit 2 Tasten
with 2 buttons

Länge / Length
3 m



HF410-024



Monopolare Elektroden

Monopolar electrodes





6-kant Schaft
6-edge shaft

Modell Model	2.4	Beschreibung Description	Abmessungen Dimensions	2,4 mm Schaft 2.4 mm shaft
		Messer-Elektrode Knife electrode	20 mm x 2,5 mm	RU 0470-54
		Nadel-Elektrode Needle electrode	18 mm x Ø 0,7 mm	RU 0470-60

Modell Model	2.4	Beschreibung Description	Abmessungen Dimensions	2,4 mm Schaft 2.4 mm shaft
		Kugel-Elektrode Ball electrode	Ø 2 mm	RU 0470-65
			Ø 4 mm	RU 0470-67

Modell Model	4	Beschreibung Description	Abmessungen Dimensions	4 mm Schaft 4 mm shaft
		Lanzetten-Elektrode Lancet electrode	19 mm x 1,6 mm	RU 0470-02

Modell Model	4	Beschreibung Description	Abmessungen Dimensions	4 mm Schaft 4 mm shaft
		Kugel-Elektrode Ball electrode	Ø 2 mm	RU 0470-15
			Ø 4 mm	RU 0470-17
			Ø 6 mm	RU 0470-19

Bipolare Scheren

Bipolar scissors

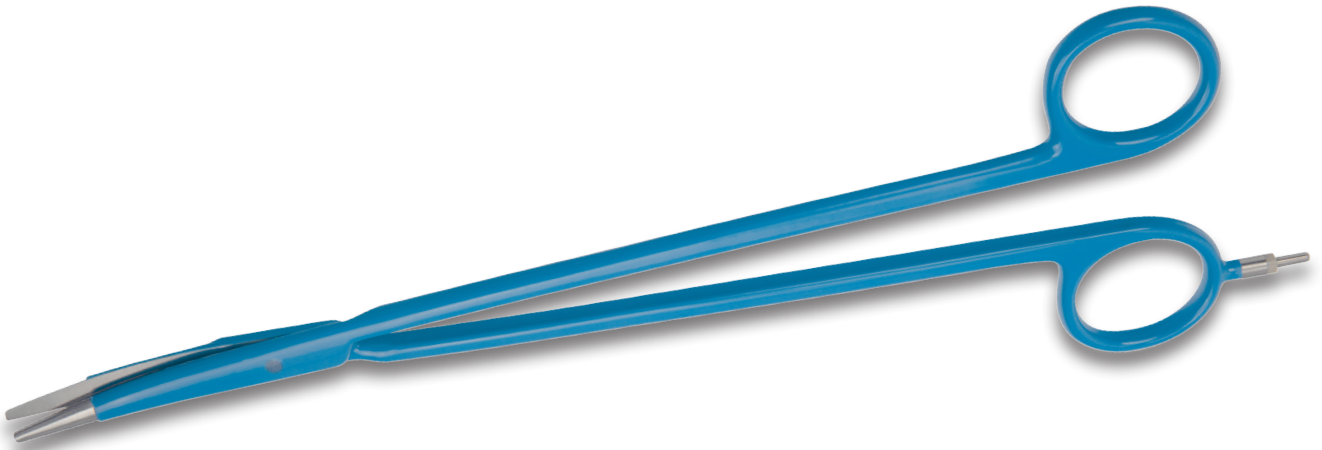

Allgemein

Merkmale unserer bipolaren Scheren:

- RUDOLF Bipolare Scheren ermöglichen das Schneiden und Präparieren bei gleichzeitiger bipolarer Koagulation.
- Präzises punkt- oder flächenförmiges Koagulieren von Gefäßen und Gewebeflächen möglich.
- Besonders anwenderfreundlich, da das Anschlusskabel nur an einem Ring befestigt wird.

General information

Features of our bipolar scissors:

- RUDOLF bipolar scissors enable cutting and dissection with simultaneous bipolar coagulation.
- Precise pinpoint or zone coagulation of blood vessels and tissue possible.
- Very user-friendly, because the connection cable is attached only to one ring.

Bipolare Scheren
Bipolar scissors

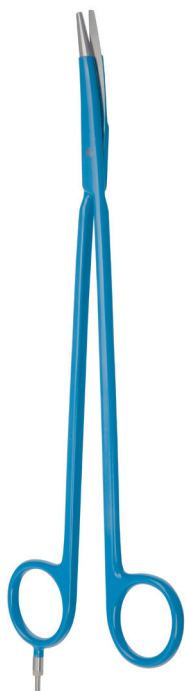



METZENBAUM



Länge <i>Length</i>	gebogen schlank <i>curved slim</i>
18 cm – 7"	RU 1382-18
23 cm – 9"	RU 1382-23

Bipolare Anschlusskabel für abgebildete Scheren
Bipolar connecting cables for illustrated scissors

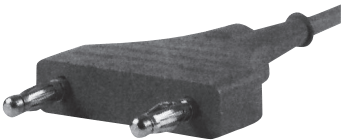
Gerätestecker <i>Plug, generator side</i>	Instrumentenstecker <i>Plug, instrument side</i>	Länge <i>Length</i>	
 Erbe		3 m	HF300-202
 Martin, Berchtold, Aesculap		3 m	HF300-204
 Valleylab, Lamidey, EMC		3 m	HF300-206

Bipolare Pinzetten

Bipolar forceps



Allgemein

Merkmale unserer bipolaren Pinzetten:

- Lieferbar mit Flachstecker, auf Anfrage auch mit 2-Pin-Stecker (US-Standard).
- Präzise schließende Arbeitsenden gewährleisten ein sicheres und schonendes Arbeiten.
- Die schlanke und feine Formgebung garantieren ein sicheres Arbeiten auch in besonders delikaten Einsatzbereichen bzw. an schwer zugänglichen Stellen.
- Die breite, geriefte Grifffläche ermöglicht eine sichere Handhabung.
- Die bewährte und äußerst beständige Isolationsbeschichtung gewährleistet die Sicherheit des Instrumentes.
- Unser Kunststoff-Sicherheitsstecker garantiert eine glatte Steckverbindung und damit sicheren elektrischen Kontakt.

NON-STICK Pinzetten:

NON-STICK Pinzetten verhindern das Verkleben des koagulierten Gewebes mit der Pinzettenspitze. Dafür sorgen spezielle polierte Edelmetallspitzen mit einer exzellenten Wärmeleitfähigkeit. Diese Antihafteigenschaften bleiben auch nach einem evtl. Nachpolieren erhalten, da die gesamten Pinzettenspitzen aus Edelmetall hergestellt sind und es sich nicht nur um eine Beschichtung handelt.

General information

Features of our bipolar forceps:

- Available with flat plug, on demand also with 2-pin-plug (US-Standard).
- The precise closing of the jaws ensures safe and gentle working.
- The slim and delicate design grants safe working in extremely delicate areas or in hard-to-reach places.
- The broad, rifeled surface of the handle ensures safe handling.
- The well proven and extremely durable isolation coating grants the safeness of the instrument.
- Our plastic-safety plug grants a smooth plugging and therefore a safe electric contact.

NON-STICK Forceps:

The NON-STICK forceps prevents the sticking of coagulated tissue on the forceps tips. This is possible due to specially polished tips made of precious metal having an excellent heat conductance. These anti-adhesion properties are not lost even after a possible re-polishing, due to the fact that the complete tip of the forceps is made of precious metal and it is not only a coating.

Bipolare Pinzetten

Bipolar forceps



Anschluss
Plug

gerade
straight

gewinkelt
angled

gebogen
curved

Länge Length	Spitzenbreite Width of tips	Standard	Standard	Standard
11 cm 4¼"	0,25 mm	HF510-011	HF510-211	HF510-411
	0,60 mm	HF510-111	HF510-311	-

Anschluss
Plug

gerade
straight

gewinkelt
angled

Länge Length	Spitzenbreite Width of tips	NON-STICK	NON-STICK
11 cm 4¼"	0,25 mm	HF510-051	HF510-251
	0,60 mm	HF510-151	HF510-351
	1,00 mm	HF510-152	-

Passende Bipolare Anschlusskabel auf Seite HF 26.

Suitable bipolar connecting cables on page HF 26.

Bipolare Pinzetten

Bipolar forceps

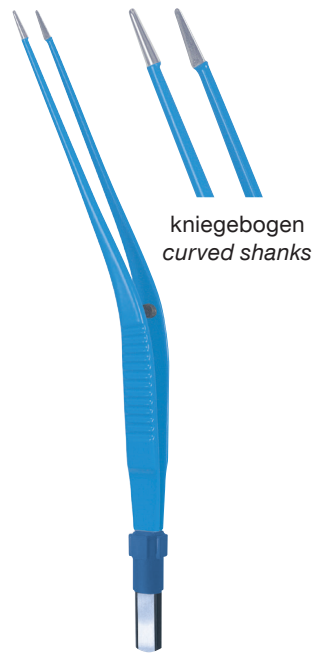

Anschluss
Plug



Länge Length	Spitzenbreite Width of tips	Standard
17 cm – 6¾"	0,30 mm	HF518-017

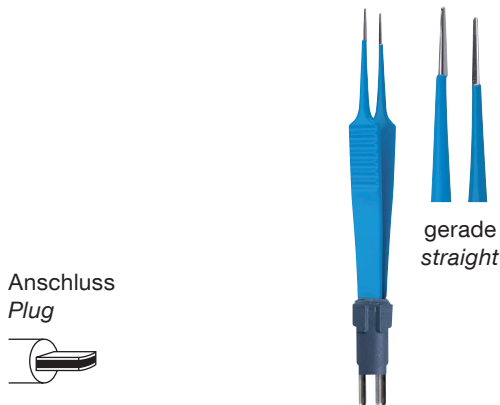

Anschluss
Plug



Länge Length	Spitzenbreite Width of tips	Standard
12 cm – 4¾"	0,80 mm	HF511-111

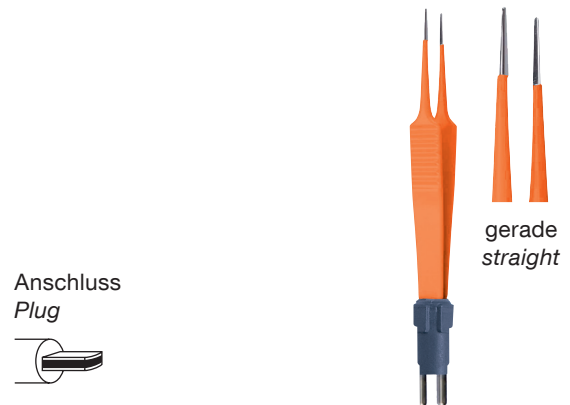

Anschluss
Plug



Länge Length	Spitzenbreite Width of tips	NON-STICK
12 cm – 4¾"	0,25 mm	HF511-051
	0,80 mm	HF511-151

Passende Bipolare Anschlusskabel auf Seite HF 26.

Suitable bipolar connecting cables on page HF 26.

Bipolare Pinzetten

Bipolar forceps



Anschluss
Plug



Länge Length	Spitzenbreite Width of tips	Standard	Standard
15 cm – 6"	0,30 mm	HF515-015	–
	1,00 mm	HF515-115	HF515-615
18 cm – 7"	0,30 mm	–	HF515-518
	1,00 mm	HF515-118	HF515-618
20 cm – 8"	0,30 mm	HF515-020	–
	1,00 mm	HF515-120	HF515-620
22 cm – 8¾"	1,00 mm	HF515-122	–
24 cm – 9½"	1,00 mm	HF515-124	–



Anschluss
Plug



Länge Length	Spitzenbreite Width of tips	NON-STICK	NON-STICK
15 cm – 6"	0,30 mm	HF515-055	–
	0,60 mm	HF515-056	–
	1,00 mm	HF515-155	HF515-655
	2,00 mm	–	HF515-656
18 cm – 7"	0,30 mm	–	HF515-558
	0,60 mm	HF515-059	–
	1,00 mm	HF515-158	HF515-658
20 cm – 8"	2,00 mm	HF515-159	HF515-659
	1,00 mm	HF515-170	–
22 cm – 8¾"	2,00 mm	HF515-171	–
	1,00 mm	HF515-172	–
	2,00 mm	HF515-173	–

Passende Bipolare Anschlusskabel auf Seite HF 26.

Suitable bipolar connecting cables on page HF 26.

Bipolare Pinzetten

Bipolar forceps



Anschluss
Plug



Länge Length	Spitzenbreite Width of tips	Standard
15 cm – 6"	1,00 mm	HF516-115
18 cm – 7"	1,00 mm	HF516-118
20 cm – 8"	0,30 mm	HF516-020
	1,00 mm	HF516-120



Anschluss
Plug



Länge Length	Spitzenbreite Width of tips	NON-STICK	NON-STICK
18 cm – 7"	0,30 mm	–	HF516-558
	1,00 mm	HF516-158	–
	2,00 mm	HF516-159	–
20 cm – 8"	1,00 mm	HF516-170	–
22 cm – 8¾"	2,00 mm	HF516-173	–

2-Pin-Stecker (US-Standard).
Passende Bipolare Anschlusskabel auf Seite HF 26.

2-pin-plug (US-Standard).
Suitable bipolar connecting cables on page HF 26.

Bipolare Pinzetten

Bipolar forceps

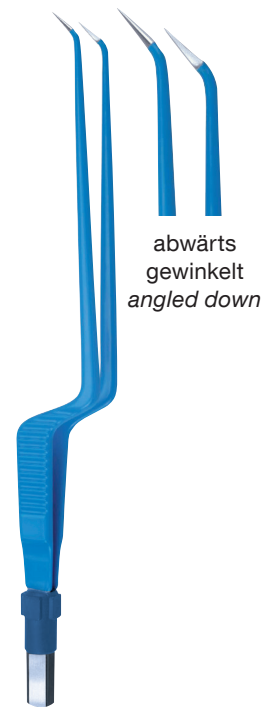
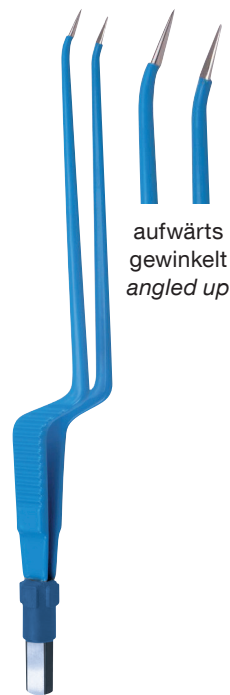
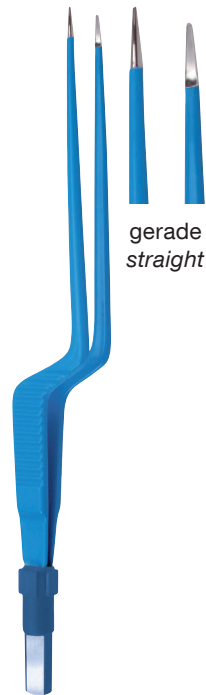

Anschluss
Plug



Länge Length	Spitzenbreite Width of tips	Standard	Standard	Standard
16,5 cm – 6½"	0,60 mm	HF520-017	–	–
18 cm – 7"	0,30 mm	HF520-018	–	–
	1,00 mm	HF520-118	HF520-518	–
20 cm – 8"	1,00 mm	HF520-120	HF520-520	–
22 cm – 8¾"	0,30 mm	HF520-022	HF520-422	–
	1,00 mm	HF520-122	HF520-522	HF520-922
24 cm – 9½"	0,30 mm	HF520-024	–	–
	1,00 mm	HF520-124	–	–

Passende Bipolare Anschlusskabel auf Seite HF 26.

Suitable bipolar connecting cables on page HF 26.

Bipolare Pinzetten

Bipolar forceps



Länge Length	Spitzenbreite Width of tips	NON-STICK	NON-STICK
18 cm – 7"	0,30 mm	HF520-058	–
	0,60 mm	HF520-059	–
	1,00 mm	HF520-158	–
	2,00 mm	HF520-159	–
20 cm – 8"	0,30 mm	HF520-070	–
	0,60 mm	HF520-071	–
	1,00 mm	HF520-170	HF520-570
	2,00 mm	HF520-171	–
22 cm – 8¾"	0,60 mm	HF520-073	–
	1,00 mm	HF520-172	HF520-572
	2,00 mm	HF520-173	–
24 cm – 9½"	0,60 mm	HF520-075	–
	1,00 mm	HF520-174	–
	2,00 mm	HF520-175	–

Passende Bipolare Anschlusskabel auf Seite HF 26.

Suitable bipolar connecting cables on page HF 26.

Bipolare Pinzetten

Bipolar forceps

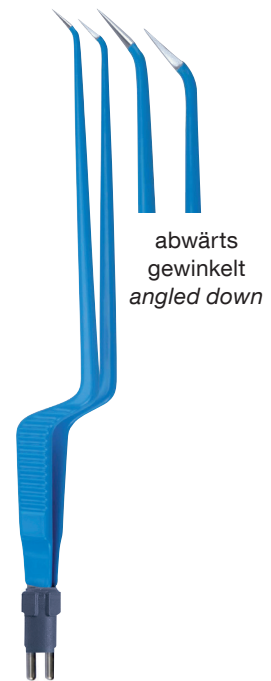
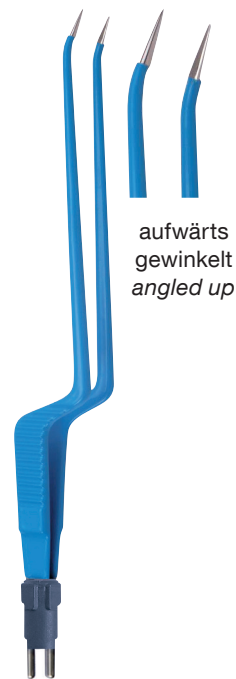
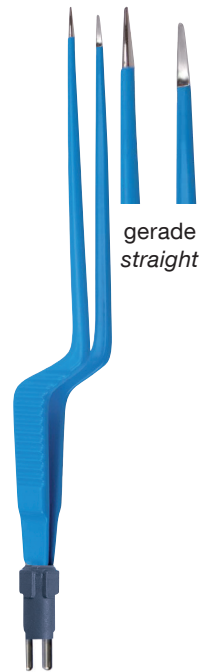

Anschluss
Plug



Länge Length	Spitzen- breite Width of tips	Standard	Standard	Standard
18 cm – 7"	1,00 mm	HF521-118	–	HF521-918
20 cm – 8"	0,30 mm	–	HF521-420	–
	1,00 mm	HF521-120	–	–
22 cm – 8¾"	1,00 mm	HF521-122	–	–

2-Pin-Stecker (US-Standard).
Passende Bipolare Anschlusskabel auf Seite HF 26.

2-pin-plug (US-Standard).
Suitable bipolar connecting cables on page HF 26.

Bipolare Pinzetten

Bipolar forceps



Länge Length	Spitzen- breite Width of tips	NON-STICK	NON-STICK	NON-STICK
18 cm – 7"	0,60 mm	HF521-059	–	–
	1,00 mm	HF521-158	–	–
	2,00 mm	HF521-159	–	–
20 cm – 8"	0,30 mm	HF521-070	–	–
	0,60 mm	HF521-071	–	–
	1,00 mm	HF521-170	HF521-570	HF521-970
	2,00 mm	HF521-171	–	–
22 cm – 8¾"	0,30 mm	HF521-072	–	–
	0,60 mm	HF521-073	–	–
	1,00 mm	HF521-172	–	–
	2,00 mm	HF521-173	–	–
24 cm – 9½"	1,00 mm	HF521-174	–	–
	2,00 mm	HF521-175	–	–

2-Pin-Stecker (US-Standard).
Passende Bipolare Anschlusskabel auf Seite HF 26.

2-pin-plug (US-Standard).
Suitable bipolar connecting cables on page HF 26.

Bipolare Pinzetten
Bipolar forceps

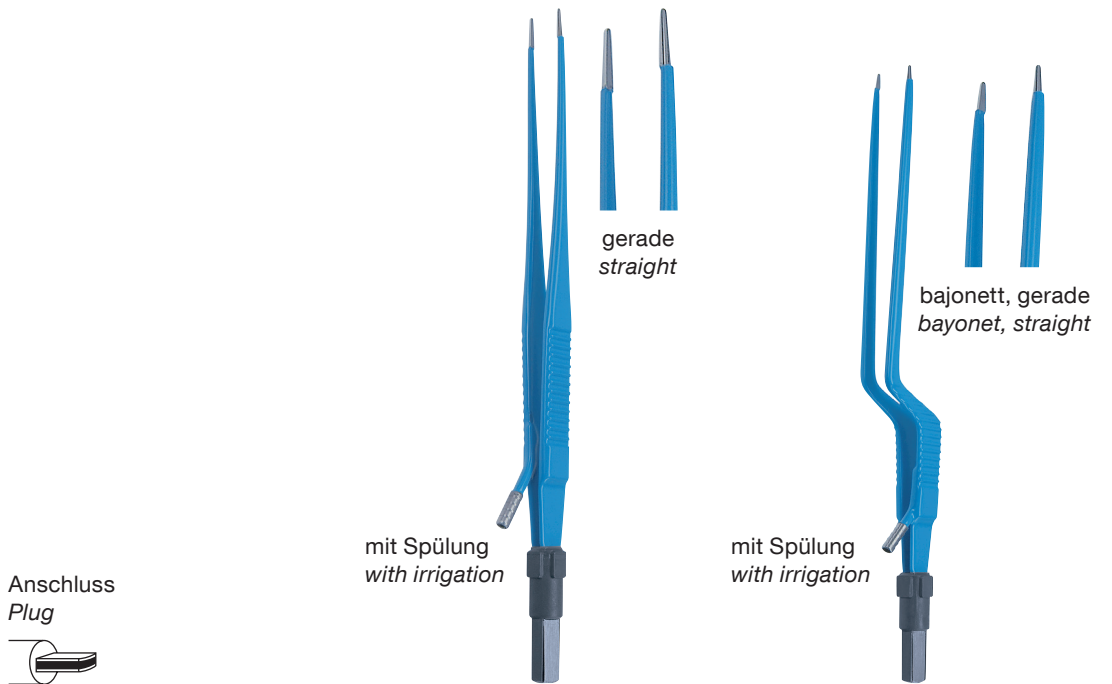

Anschluss
 Plug



Länge Length	Spitzenbreite Width of tips	Standard	Standard
18cm – 7"	0,5 x 8 mm	HF530-018	–
	1,0 x 8 mm	–	HF532-118

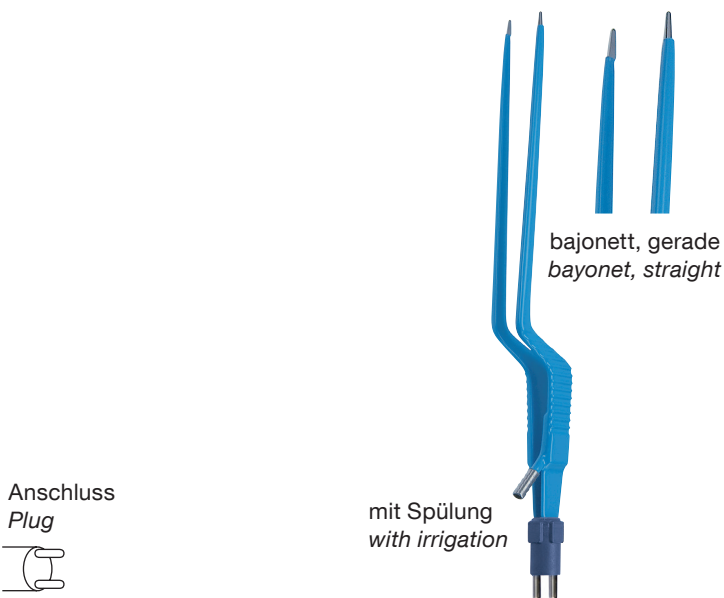

Anschluss
 Plug









Länge Length	Spitzenbreite Width of tips	Standard
20 cm – 8"	1,5 x 8 mm	HF533-220

2-Pin-Stecker (US-Standard).
 Passende Bipolare Anschlusskabel auf Seite HF 26.

2-pin-plug (US-Standard).
 Suitable bipolar connecting cables on page HF 26.

Bipolare Anschlusskabel
Bipolar connecting cables

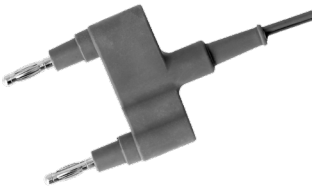

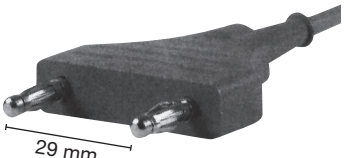
		Flachstecker <i>Flat plug</i>		2-Pin Stecker US-Standard <i>2-pin plug US-Standard</i>	
					
		Instrumentenseite <i>Instrument side</i>			
Geräteseite <i>Generator side</i>	Länge <i>Length</i>		Länge <i>Length</i>		
 Steg biegsam / <i>flexible joint</i>	4 m	HF310-104	4 m	HF310-3031	
 Erbe	3 m	HF310-113	–	–	
 Martin, Berchtold, Aesculap	3 m	HF310-123	–	–	
	5 m	HF310-125	–	–	
 Valleylab, Lamidey, EMC 29 mm	3 m	HF310-133	3 m	HF310-333	
	5 m	HF310-135	–	–	



Chirurgische Scheren	<i>Operating Scissors</i>	29 — 30
Chirurgische Scheren, Präparierscheren	<i>Operating Scissors, Dissecting Scissors</i>	31 — 32
Präparierscheren	<i>Dissecting Scissors</i>	32 — 35 40 — 42
Präparierscheren, feine chirurgische Scheren	<i>Dissecting Scissors, Fine Operating Scissors</i>	36 — 38
Feine Scheren	<i>Fine Scissors</i>	39, 47—50
Tonsillenscheren, Nasenscheren	<i>Tonsil Scissors, Nasal Scissors</i>	43 — 46
Ligaturscheren, Drahtscheren	<i>Ligature Scissors, Wire Cutting Scissors</i>	51
Verbandscheren	<i>Bandage Scissors</i>	52
Scheren	<i>Scissors</i>	53
Arterienklemmen	<i>Hemostatic Forceps</i>	54 — 59
Tonsillen- Klemmzangen,- Klemmen	<i>Tonsil Forceps</i>	59 — 61
Tuchklemmen	<i>Towel Forceps</i>	61
Korn- (Polypen) -Zangen, Sinusklemmen	<i>Polypus and Dressing Forceps, Sinus Forceps</i>	62
Bulldogklemmen	<i>Bulldog Clamps</i>	63
Fasszangen	<i>Grasping Forceps</i>	64
Anatomische Pinzetten	<i>Dressing Forceps</i>	65, 66
Anatomische Pinzetten, Tumorfasspinzetten	<i>Dressing Forceps, Tumor Grasping Forceps</i>	66, 68
Mikro - Pinzetten	<i>Micro Forceps</i>	67 — 68
Chirurgische Pinzetten	<i>Tissue Forceps</i>	69 — 70
Uhrmacherpinzetten, Feine Pinzetten	<i>Watchmaker's Forceps, Fine Forceps</i>	71
Splitterpinzetten, Atraumatische Pinzetten	<i>Splinter Forceps, Atraumatic Tissue Forceps</i>	72
Atraumatische-, Ohr- und Nasenpinzetten	<i>Atraumatic Forceps, Aural and Nasal Forceps</i>	73
Bulldogklemmen	<i>Bulldog Clamps</i>	73
Nasen-, Columella- und chirurgische Pinzetten	<i>Nasal Forceps, Columella Forceps, Tissue Forceps</i>	74
Wund- und Nervhäkchen	<i>Wound and Nerve Hooks</i>	75
Wund-, Haut- und Trachealhäkchen	<i>Wound and Trachea Hooks</i>	76 — 78
Wund- und Trachealhäkchen	<i>Wound and Trachea Hooks</i>	79
Wundhaken	<i>Retractors</i>	80 — 84
Wundsperrer	<i>Retractors</i>	85 — 88



Wundsperrer, Wangen- und Lippenhalter	<i>Retractors, Cheek and Lip Retractor</i>	89
Skalpellsgriffe	<i>Scalpel Handles</i>	90 — 91
Skalpellsklingen	<i>Scalpel Blades</i>	92
Mini-Klingen, Skalpellgriffe	<i>Mini Blades, Scalpel Handle</i>	93 — 94
Fistelmesser	<i>Fistula Knives</i>	95
Sonden, Dilatatoren, Pflasterspatel, Watteträger	<i>Probes, Dilators, Plaster Spatulas, Cotton Applicators</i>	96 — 98
Kaltlicht-Stirnlampen	<i>Fiber optic headlights</i>	99 — 100
Führungsnadeln	<i>Guide Needles</i>	101
Katheterzangen	<i>Catheter Forceps</i>	102
Flach- und Hohlmeißel, Osteotome, Stößel	<i>Bone Chisels, Gouges, Osteotomes, Pestles</i>	103 — 104
Scharfe Löffel	<i>Bone Curettes</i>	105 — 106
Raspatorien, Elevatorien	<i>Raspatories, Elevators</i>	107 — 108
Elevatorien, Hohlmeißelzangen	<i>Elevators, Bone Rongeur Forceps</i>	109 — 111
Hohlmeißelzangen, Knochensplitterzangen	<i>Bone Rongeur Forceps, Bone Cutting Forceps</i>	112
Hämmer	<i>Mallets</i>	113
Mikro-Nadelhalter	<i>Micro Needle Holders</i>	114
Nadelhalter	<i>Needle Holders</i>	115 — 120
Unterbindungs-nadeln	<i>Ligature Needles</i>	121
Führungshohlsonden	<i>Ligature Conductors</i>	122
Absaugrohre	<i>Suction Tubes</i>	123
Absaugrohre, Saug-Raspatorium	<i>Suction Tubes, Suction Raspatory</i>	124



mit extra großen Ringen
 with extra large rings

Mod. Rudolf
 14,5 cm / 5¾"
 gerade / straight
RU 1000-14



Standard
 Fig. 1
 gerade / straight



Standard
 Fig. 2
 gerade / straight



Standard
 Fig. 3
 gerade / straight

11,5 cm / 4½"	RU 1001-11	RU 1002-11	RU 1003-11
13,0 cm / 5"	RU 1001-13	RU 1002-13	RU 1003-13
14,5 cm / 5¾"	RU 1001-14	RU 1002-14	RU 1003-14
15,5 cm / 6"	RU 1001-15	RU 1002-15	RU 1003-15
16,5 cm / 6½"	RU 1001-16	RU 1002-16	RU 1003-16



Standard
 14,5 cm / 5¾"
 gerade / straight



Fig. 1
RU 1004-14



Fig. 2
RU 1006-14



Fig. 3
RU 1008-14



mit extra großen Ringen
 with extra large rings

Mod. Rudolf
 14,5 cm / 5¾"
 gebogen / curved
RU 1010-14



Standard
 Fig. 1
 gebogen / curved



Standard
 Fig. 2
 gebogen / curved



Standard
 Fig. 3
 gebogen / curved

11,5 cm / 4½"	RU 1011-11	RU 1012-11	RU 1013-11
13,0 cm / 5"	RU 1011-13	RU 1012-13	RU 1013-13
14,5 cm / 5¾"	RU 1011-14	RU 1012-14	RU 1013-14
15,5 cm / 6"	RU 1011-15	RU 1012-15	-
16,5 cm / 6½"	RU 1011-16	RU 1012-16	RU 1013-16



Standard
 14,5 cm / 5¾"
 gebogen / curved



Fig. 1
RU 1014-14



Fig. 2
RU 1016-14



Fig. 3
RU 1018-14

Chirurgische Scheren, Präparierscheren
Operating scissors, dissecting scissors



Standard
— Grazil —
gerade /straight
14,5 cm /5¾"

RU 1022-14 **RU 1023-14**



Standard
— Grazil —
gebogen /curved
14,5 cm /5¾"

RU 1031-14 **RU 1032-14** **RU 1033-14**



Lexer
16 cm /6¼"
RU 1101-16



Mayo

14,5 cm / 5¾"

gerade /straight
RU 1250-14



gebogen /curved
RU 1251-14



Mayo

14,5 cm / 5¾"

gerade /straight
RU 1252-14

gebogen /curved
RU 1253-14



Baby-Metzenbaum

11,5 cm / 4½"

gerade /straight
RU 1280-11



gebogen /curved
RU 1281-11



Baby-Metzenbaum

11,5 cm / 4½"

gerade, gezahnt
 straight, serrated
RU 1280-11M

gebogen, gezahnt
 curved, serrated
RU 1281-11M



Metzenbaum-Fino

14,5 cm / 5¾"

gerade /straight
RU 1290-14

gebogen /curved
RU 1291-14

Metzenbaum-Fino

14,5 cm / 5¾"

gerade, gezahnt
 straight, serrated
1290-14M

gebogen, gezahnt
 curved, serrated
RU 1291-14M

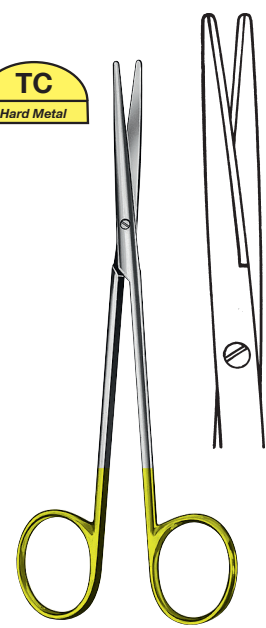

Metzenbaum

14,5 cm / 5¾"
 gerade /straight
RU 1301-14

Metzenbaum

14,5 cm / 5¾"
 gerade /straight
RU 1304-14

Metzenbaum-Fino

14,5 cm / 5¾"
 gerade /straight
RU 1306-14



Metzenbaum
 14,5 cm / 5¾"
 gebogen / *curved*
RU 1311-14



Metzenbaum
 14,5 cm / 5¾"
 gebogen, gezahnt
curved, serrated
RU 1311-14M

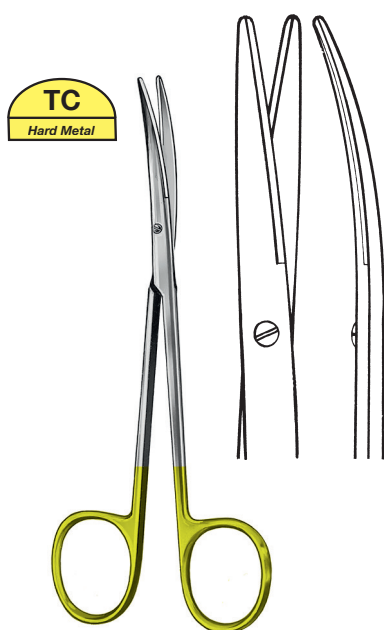

Metzenbaum
 14,5 cm / 5¾"
 gebogen / *curved*
RU 1314-14



Metzenbaum-Fino
 14,5 cm / 5¾"
 gebogen / *curved*
RU 1316-14



Metzenbaum

gerade /straight
 18 cm /7" **RU 1321-18**
 20 cm /8" **RU 1321-20**



Metzenbaum-Fino

18 cm /7"
 gerade /straight
RU 1326-18



Metzenbaum-Fino

gebogen /curved
 18 cm /7" **RU 1330-18**
 20 cm /8" **RU 1330-20**



Metzenbaum

gebogen /curved
 18 cm /7" **RU 1331-18**
 20 cm /8" **RU 1331-20**



**Metzenbaum
 Metzenbaum-Fino**

gebogen, gezahnt
 curved, serrated

Metzenbaum
 18 cm /7" **RU 1331-18M**
 20 cm /8" **RU 1331-20M**

Metzenbaum-Fino
 18 cm /7" **RU 1330-18M**

Präparierscheren, feine chirurgische Scheren
Dissecting scissors, fine operating scissors



Metzenbaum
 gebogen /curved
RU 1334-18
RU 1334-20

Metzenbaum-Fino
 gebogen /curved
RU 1336-18
RU 1336-20

18 cm /7"
 20 cm /8"



12 cm /4¾"
 gerade /straight
RU 1503-12



12 cm /4¾"
 gebogen /curved
RU 1513-12



Plastic Surgery
 12 cm /4¾"
 gerade, gezahnt
 straight, serrated
RU 1503-12M

gebogen, gezahnt
 curved, serrated
RU 1513-12M



11,5 cm / 4½"

gerade, gezahnt
straight, serrated
RU 1518-11M

gebogen, gezahnt
curved, serrated
RU 1519-11M



Wagner
 12 cm / 4¾"



gerade
straight

Fig. 1
RU 1521-12



gerade
straight

Fig. 3
RU 1523-12



gebogen
curved

Fig. 3
RU 1526-12



Reynolds

gerade /straight

RU 1580-15 15 cm /6"
 - 18 cm /7"



gebogen /curved

RU 1581-15
RU 1581-18



Reynolds

15 cm /6"

gerade, gezahnt
 straight, serrated
RU 1580-15M

gebogen, gezahnt
 curved, serrated
RU 1582-15M



Jameson

gezahnt /serrated
 15 cm /6" **RU 1583-15M**
 18 cm /7" **RU 1583-18M**

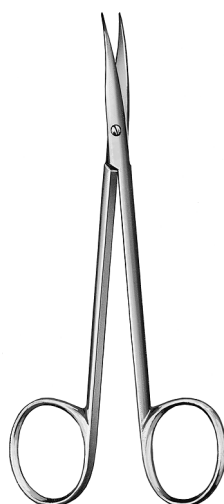

Jameson-Werber

13 cm /5"
 gebogen /curved
RU 1584-13

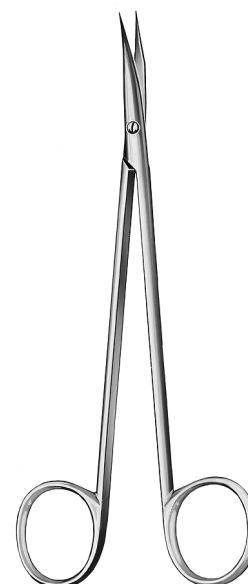

Jameson-Werber

15 cm /6"
 gebogen /curved
RU 1584-15



11,5 cm / 4½"
 gerade, gezahnt gebogen, gezahnt
straight, serrated curved, serrated
RU 1630-09 M RU 1631-09 M
RU 1630-11 M RU 1631-11 M

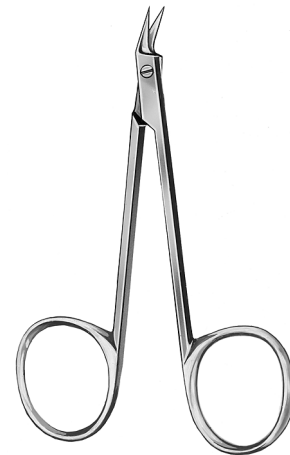

9 cm / 3½"
RU 1636-09

RU 1630-09, 10, 11 und /and
 RU 1631-09, 10, 11
 siehe Seite 42 /see page 42



Baby-Lexer (Knapp)
 10 cm / 4"
 gerade /straight
RU 1650-10



gebogen /curved
RU 1651-10



gerade /straight
RU 1670-14



Joseph
 14 cm / 5½"
 gebogen /curved
RU 1671-14



Kilner (Ragnell)

12 cm /4³/₄" **RU 1675-12**
13 cm /5" **RU 1675-13**
15 cm /6" **RU 1675-15**



Mod. Rudolf
11 cm /4¹/₂"
gebogen, gezahnt
curved, serrated
RU 1676-11M

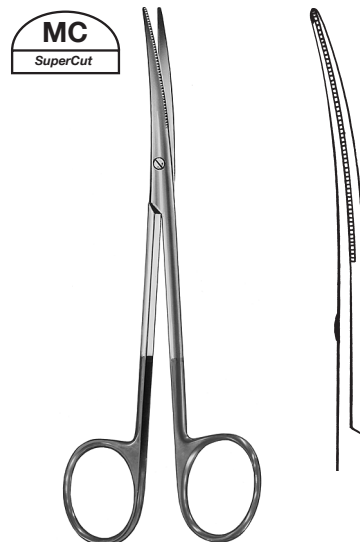

Mod. Rudolf
14 cm /5¹/₂"
gebogen, gezahnt
curved, serrated
RU 1676-14M



Reynolds
 13 cm / 5"
 gezahnt / serrated
RU 1677-13M

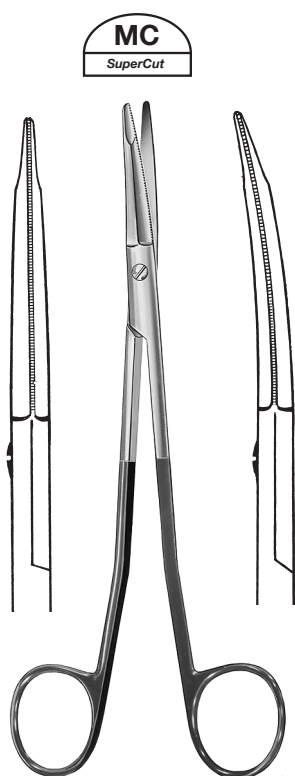

Freeman-Kaye
 18 cm / 7"
 gerade, gezahnt gebogen, gezahnt
straight, serrated curved, serrated
RU 1680-18M RU 1681-18M

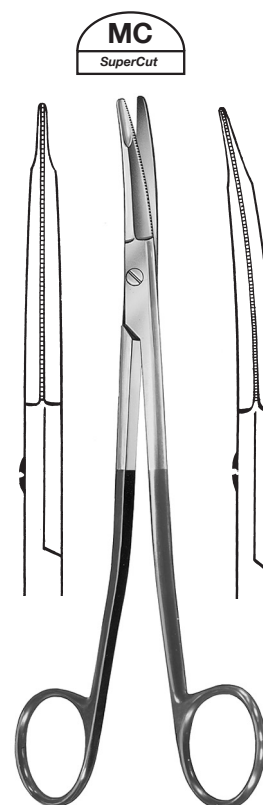

Freeman-Gorney
 19 cm / 7½"
 gerade, gezahnt gebogen, gezahnt
straight, serrated curved, serrated
RU 1682-19M RU 1683-19M

Präparierscheren
Dissecting scissors



Gorney

19 cm / 7½"

gerade
straight

gebogen
curved

RU 1688-19M

RU 1689-19M



Freeman

18 cm / 7"

gebogen
curved

RU 1693-18M



M Indoe

19 cm / 7½"

RU 1730-19

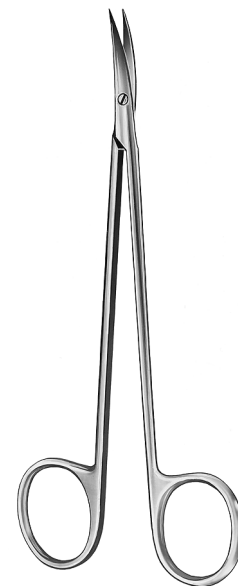

15 cm / 6"

RU 1792-15

Nerv-Präparierschere
Nerve dissecting scissors



Böttcher
 18 cm / 7"
 stumpf / blunt
RU 1810-18



Prince
 17,5 cm / 7"
RU 1815-17



Tönnis
 18 cm / 7"
 gebogen / curved
RU 1821-18



Tönnis-Adson
 17,5 cm / 7"
RU 1825-17



Tönnis-Adson
 17,5 cm / 7"
RU 1829-17

Tonsillenscheren, Nasenscheren
Tonsil scissors, nasal scissors



Good
19 cm / 7½"
RU 1845-19



Heymann
18 cm / 7"
RU 2115-18



Heymann
18 cm / 7"
gezahnt /serrated
RU 2115-18M



Fomon
13 cm /5"
abgewinkelt
angled
RU 2129-13



Fomon
13 cm /5"
abgewinkelt
angled
RU 2130-13



Fomon
13,5 cm /5¼"
schlank, gezahnt
delicate, serrated
RU 2131-13



Fomon
13,5 cm /5¼"
schlank, gezahnt
delicate, serrated
RU 2131-13M



Fomon
13,5 cm / 5 1/4"
RU 2132-13



Fomon
13 cm / 5"
gezahnt / serrated
RU 2132-13M



Cottle
16 cm / 6 1/4"
RU 2136-16



Cottle
16 cm / 6 1/4"
gezahnt / serrated
RU 2135-16M





	Fino gerade /straight	Fino gebogen /curved
10,5 cm /4¼"	RU 2418-10	RU 2419-10
11,5 cm /4½"	RU 2418-11	RU 2419-11



	gerade /straight	gebogen /curved	Fino gerade /straight	Fino gebogen /curved
9,5 cm /3¾"	RU 2420-09	RU 2421-09	RU 2422-09	RU 2423-09
10,5 cm /4¼"	RU 2420-10	RU 2421-10	RU 2422-10	RU 2423-10
11,5 cm /4½"	RU 2420-11	RU 2421-11	RU 2422-11	RU 2423-11

Feine Scheren
Fine scissors



gerade /straight
RU 2406-11

11,5 cm /4½"



gebogen /curved
RU 2407-11

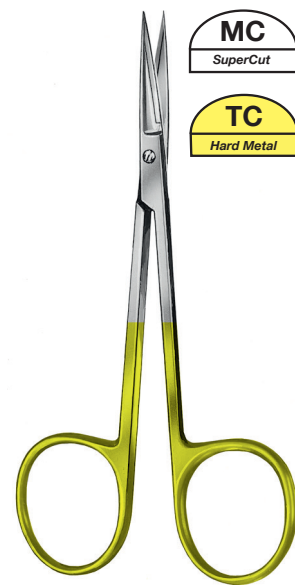

gerade, gezahnt /straight, serrated
RU 2406-11 M

11,5 cm /4½"

gebogen, gezahnt /curved, serrated
RU 2407-11M



gerade /straight
RU 1630-09

9,0 cm /3½"

RU 1630-10

10,5 cm /4¼"

RU 1630-11

11,5 cm /4½"



gebogen /curved
RU 1631-09

9,0 cm /3½"

RU 1631-10

RU 1631-11

Standard

Feine Scheren
Fine scissors



Stevens



spitz /sharp



stumpf /blunt



	gerade straight	gebogen curved	gerade straight	gebogen curved
10,5 cm /4¼"	RU 2430-10	RU 2431-10	RU 2440-10	RU 2441-10
11,5 cm /4½"	RU 2430-11	RU 2431-11	RU 2440-11	RU 2441-11



Stevens

11,5 cm /4½"

gerade, gezahnt
straight, serrated

RU 2440-11M

gebogen, gezahnt
curved, serrated

RU 2441-11M



Graefe

10,5 cm /4¼"
RU 2455-10



Wilmer

10 cm /4"
RU 2457-10



11,5 cm /4½"

gerade, straight
RU 2460-11

gebogen, curved
RU 2461-11

Strabismusschere /Strabismus scissors

Feine Scheren
Fine scissors



11,5 cm / 4½"

gerade
straight

RU 2462-11

Strabismusscheren / *Strabismus scissors*



gebogen
curved

RU 2463-11



11,5 cm / 4½"

gebogen, gezahnt
curved, serrated

RU 2463-11M

Strabismusscheren
Strabismus scissors



9,5 cm / 3¾"

gebogen
curved

RU 2476-03

Ligaturscheren, Drahtscheren
Ligature scissors, wire cutting scissors



Littauer
 14 cm / 5½"
RU 2500-14



Spencer
 9 cm / 3½"
RU 2510-09



Spencer
 10,5 cm / 4¼" **RU 2510-10**
 12,0 cm / 4¾" **RU 2510-12**



Northbent
 12,5 cm / 5"
RU 2520-12



Universal
 12 cm / 4¾"
 gezahnt / serrated
RU 2600-12

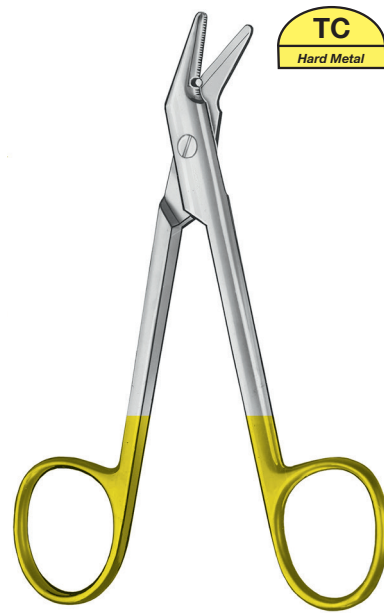

Universal
 12 cm / 4¾"
 gezahnt / serrated
RU 2601-12



Mod. Rudolf
16 cm / 6¼"
RU 2602-16



Universal
18 cm / 7"
RU 2602-18



Lister
11,0 cm / 4½" **RU 2650-11**
14,0 cm / 5½" **RU 2650-14**
15,5 cm / 6" **RU 2650-15**
18,0 cm / 7" **RU 2650-18**



Goldmann – Fox
13 cm / 5"
gebogen, gezahnt
curved, serrated
RU 2903 – 13



gerade / *straight*
RU 2980 – 09
RU 2980 – 10

9,0 cm / 3½"
10,5 cm / 4¼"



gebogen / *curved*
–
RU 2981 – 10

Arterienklemmen
Hemostatic forceps

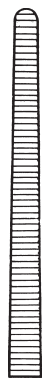

gerade
straight

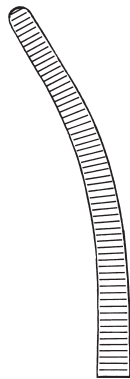

gebogen
curved



gerade
straight

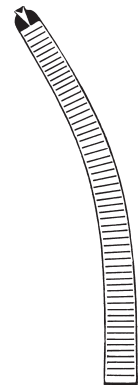
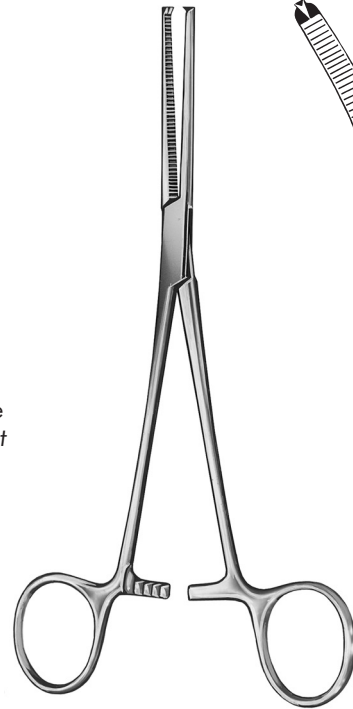

gebogen
curved

Rochester-Péan

Ochsner-Kocher

RU 3000-13	RU 3001-13	13 cm /5"	RU 3010-13	RU 3011-13
RU 3000-14	RU 3001-14	14 cm /5½"	RU 3010-14	RU 3011-14
RU 3000-16	RU 3001-16	16 cm /6¼"	RU 3010-16	RU 3011-16
RU 3000-18	RU 3001-18	18 cm /7"	RU 3010-18	RU 3011-18
RU 3000-20	RU 3001-20	20 cm /8"	RU 3010-20	RU 3011-20



gerade
straight



gebogen
curved

◀ fein
fine ▶



gerade
straight

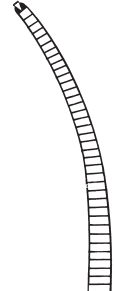

gebogen
curved

Péan

Kocher

RU 3020-13	RU 3021-13	13 cm /5"	RU 3030-13	RU 3031-13
RU 3020-14	RU 3021-14	14 cm /5½"	RU 3030-14	RU 3031-14

Arterienklemmen
Hemostatic forceps



Kelly

14 cm / 5½"

Kelly-Rankin

16 cm / 6¼"

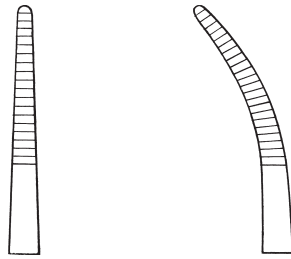

14 cm / 5½"

RU 3050-14

RU 3051-14

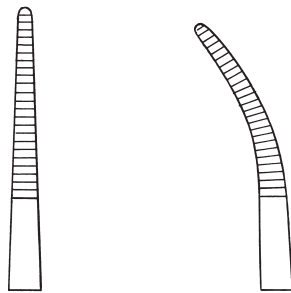

16 cm / 6¼"

RU 3050-16

RU 3051-16

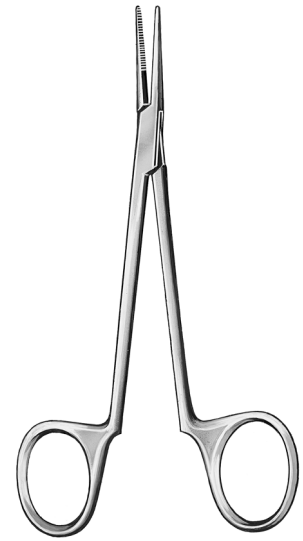

14 cm / 5½"

gerade
straight

gebogen
curved

RU 3068-14

RU 3069-14

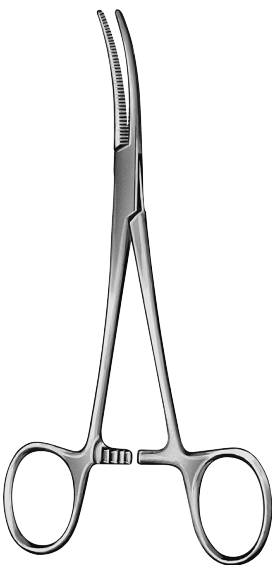

Crile

14 cm / 5½"

Crile-Rankin

16 cm / 6¼"

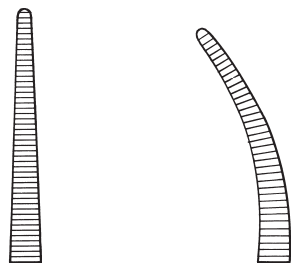

14 cm / 5½"

RU 3070-14

RU 3071-14

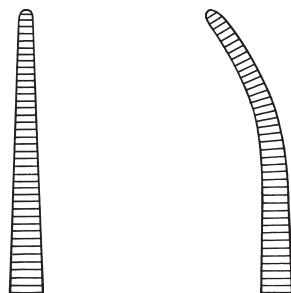

16 cm / 6¼"

RU 3070-16

RU 3071-16



Baby-Crile

14 cm / 5½"



RU 3072-14



RU 3073-14

Arterienklemmen
Hemostatic forceps

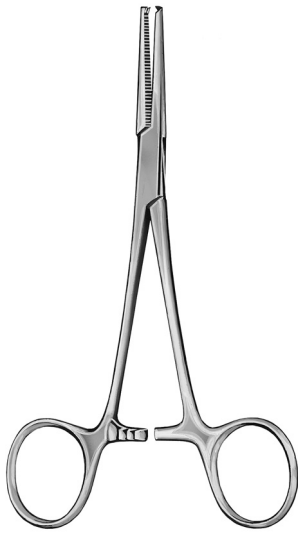

Crile
 14 cm / 5½"

Crile-Rankin
 16 cm / 6¼"

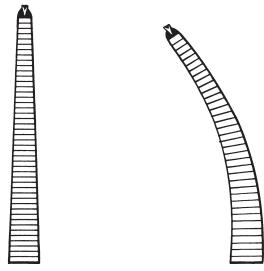

14 cm / 5½"
RU 3074-14 **RU 3075-14**

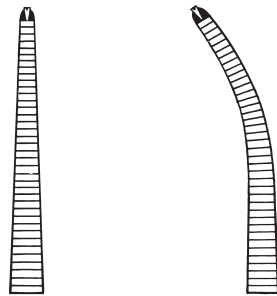

16 cm / 6¼"
RU 3074-16 **RU 3075-16**



Baby-Crile
 14 cm / 5½"



RU 3076-14

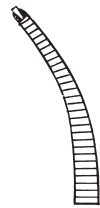

RU 3077-14



Leriche
 15 cm / 6"

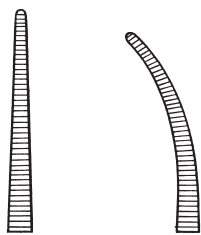

RU 3080-15 **RU 3081-15**

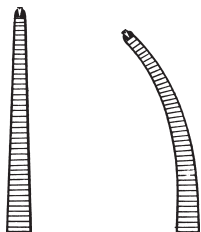

RU 3082-15 **RU 3083-15**



Providence
 14 cm / 5½"



RU 3090-14



RU 3091-14

Arterienklemmen
Hemostatic forceps

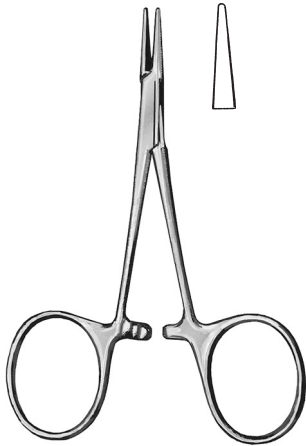

9,5 cm / 3¾"
RU 3097-09
 Ligaturklemme, glatt
 Ligature forceps, smooth



Halsted-Mosquito
 12 cm / 4¾"
 14 cm / 5½"



RU 3100-12
RU 3100-14



RU 3101-12
RU 3101-14



RU 3110-12
RU 3110-14



RU 3111-12
RU 3111-14



Halsted-Mosquito
 18 cm / 7"
 21 cm / 8¼"



RU 3100-18
RU 3100-21



RU 3101-18
RU 3101-21



RU 3110-18
RU 3110-21



RU 3111-18
RU 3111-21



DeBAKEY

Atrauma-Arterienklemmen
 Atrauma hemostatic forceps



Mosquito
 12 cm / 4¾"



RU 7680-12



RU 7681-12

Arterienklemmen
Hemostatic forceps

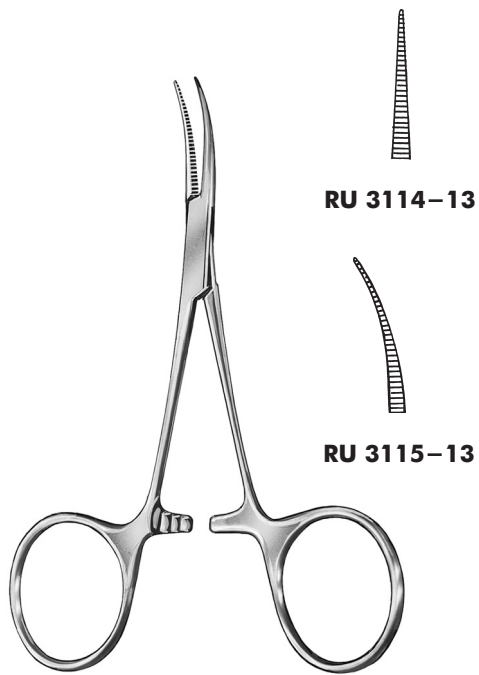

Jacobson-Halsted
 13 cm / 5"
 sehr fein / very fine



Micro-Mosquito
 10 cm / 4"
 12 cm / 4¾"

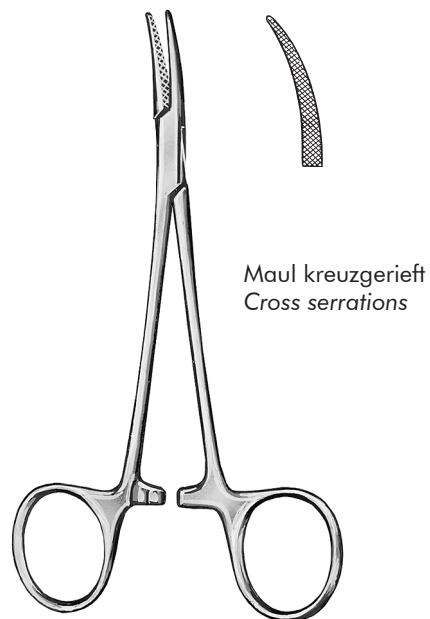

12 cm / 4¾"
RU 3137-12



Hartmann
 10 cm / 4"

Arterienklemmen, Tonsillen-Klemmzangen
Hemostatic forceps, tonsil forceps

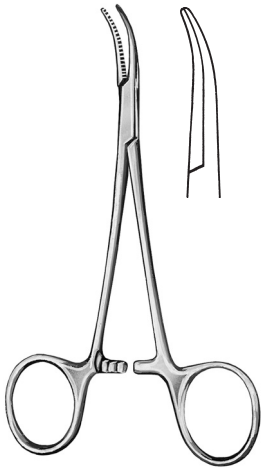

Mosquito-Dandy
 12 cm / 4¾"
 seitwärts gebogen
lateral curved

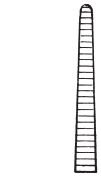

RU 3179-12



RU 3181-12



Adson
 18,5 cm / 7¼"



RU 3200-18

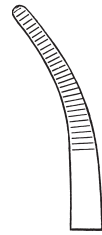

RU 3201-18



Baby-Adson

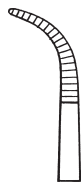

14 cm / 5½"
RU 3205-14



18 cm / 7"
RU 3205-18



Schnidt
 19 cm / 7½"
 Tonsillen-Klemmzange
Tonsil forceps



RU 8570-01

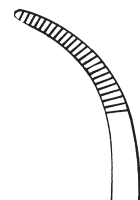

RU 8570-02

Arterienklemmen, Tonsillen-Klemmzangen
Hemostatic forceps, tonsil forceps

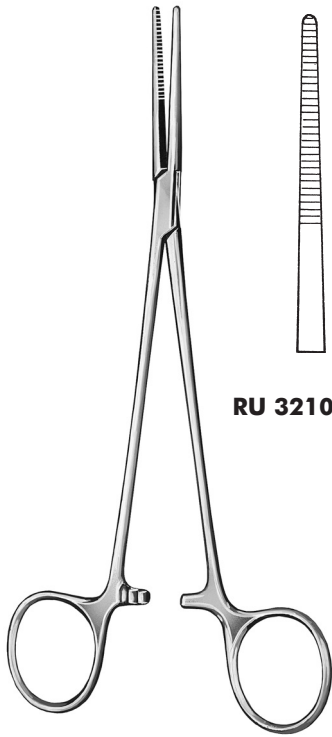

Birkett
 19 cm / 7½"

RU 3210-19

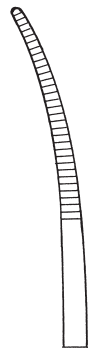

RU 3211-19



Baby-Overholt
 13,5 cm / 5¼"
 RU 3289-14

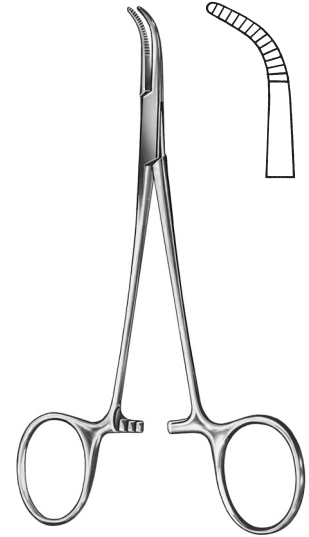
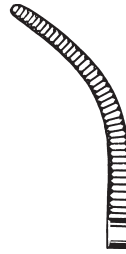

Baby-Mixer
 14 cm / 5½" 18 cm / 7"
 RU 3328-14 RU 3328-18



Negus
 19 cm / 7½"

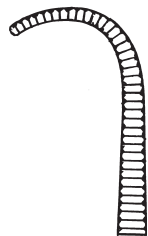

Fig. 1
 RU 3387-01

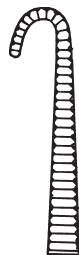
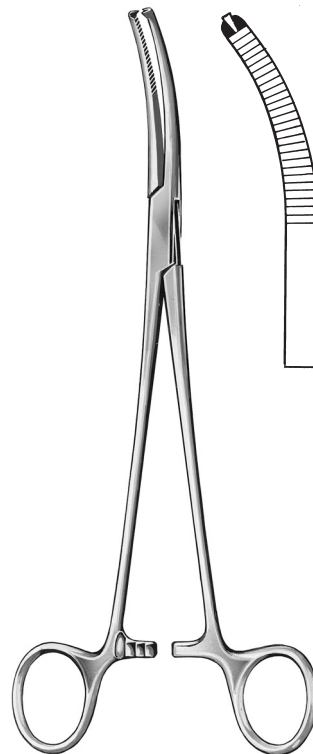
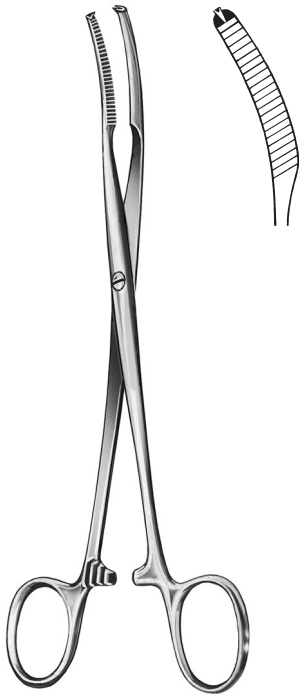

Fig. 2
 RU 3387-02



Mikulicz
 20 cm / 8"
 RU 3501-20

Tonsillenklemmen, Tuchklemmen
Tonsil forceps, towel forceps



Mikulicz
 18 cm / 7"
RU 3504-18

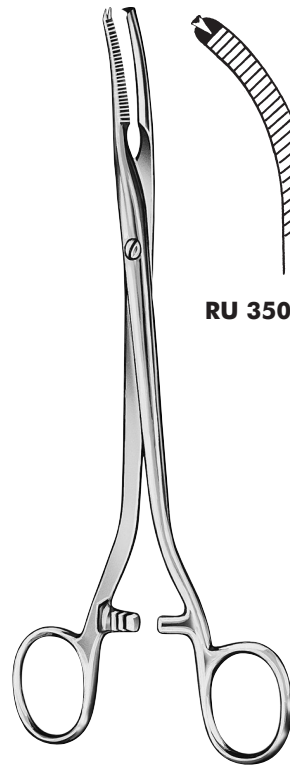

RU 3505-20

Mikulicz
 20 cm / 8"

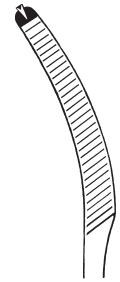

RU 3506-20



Schädel
 9 cm / 3½"
RU 3550-09



Jones
 5 cm / 2" **RU 3552-05**
 9 cm / 3½" **RU 3552-09**

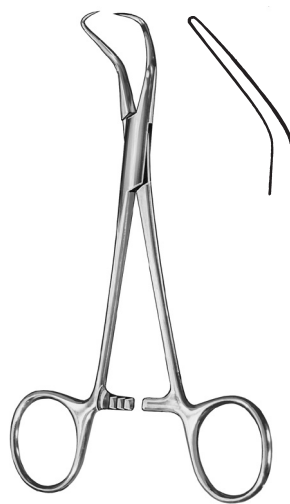

Backhaus
 9 cm / 3½" **RU 3600-09**
 11 cm / 4½" **RU 3600-11**
 13 cm / 5" **RU 3600-13**
 15 cm / 6" **RU 3600-15**

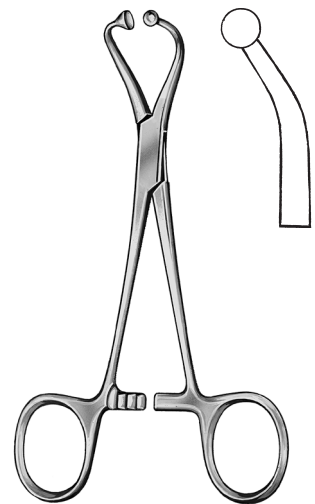

11 cm / 4½" **RU 3617-11**
 13 cm / 5" **RU 3617-13**

Korn-(Polypen) Zangen, Sinusklemmen
Polypus and dressing forceps, sinus forceps



Ulrich
 22 cm / 8³/₄"

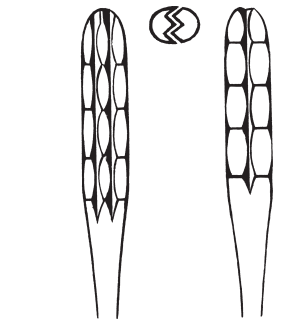

gerade
 straight
RU 3800-22

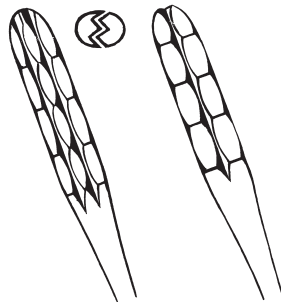

gebogen
 curved
RU 3801-22

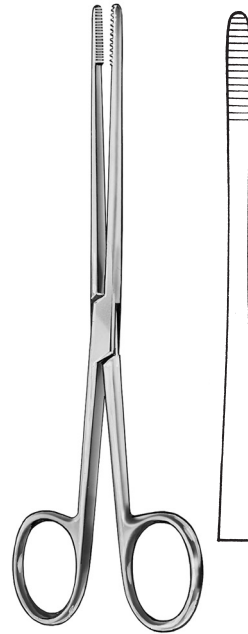

Lister

12,5 cm / 5" **RU 3810-12**
 16,0 cm / 6¹/₄" **RU 3810-16**
 18,0 cm / 7" **RU 3810-18**
 Sinusklemme / Sinus forceps

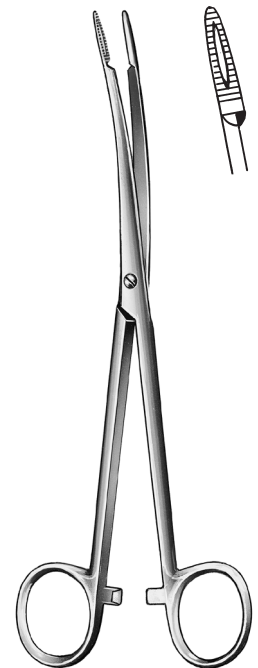

17,5 cm / 7"
 gebogen / curved
RU 3815-17



Gross-Maier

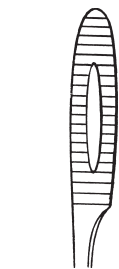

gerade / straight
 20 cm / 8" **RU 3860-20**
 25 cm / 10" **RU 3860-25**

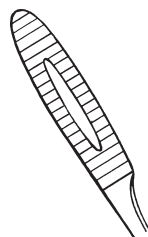

gebogen / curved
 20 cm / 8" **RU 3861-20**
 25 cm / 10" **RU 3861-25**

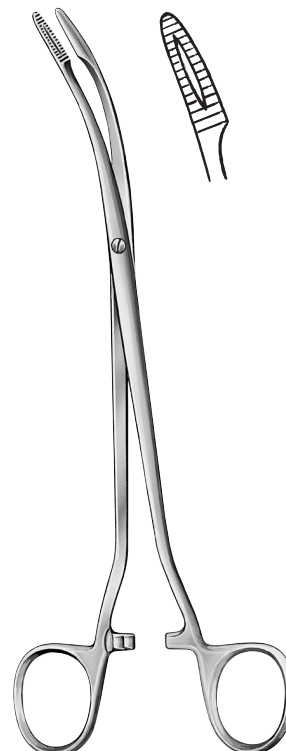

Duplay
 20 cm / 8"
RU 3881-20

Bulldogklemmen
Bulldog clamps

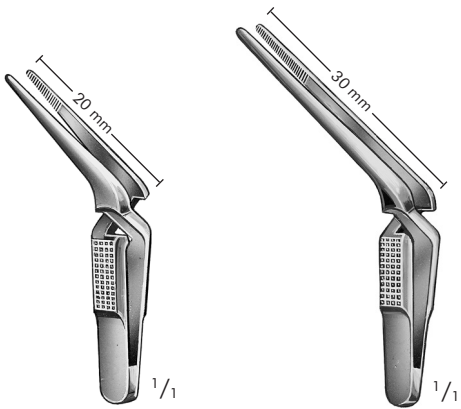

De Bakey-Hess
 4,5 cm / 1³/₄"
RU 3936-20

De Bakey-Hess
 5,5 cm / 2¹/₄"
RU 3936-30



DEBAKEY

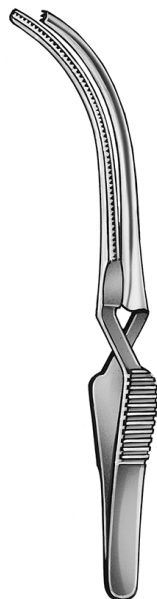

RU 7586-07
RU 7586-08

8 cm / 3¹/₈"
 9 cm / 3¹/₂"

RU 7587-07
RU 7587-08

verwendbar mit:
 RU 7586-07, RU 7586-08
 RU 7587-07, RU 7587-08

useable with:
 RU 7586-07, RU 7586-08
 RU 7587-07, RU 7587-08

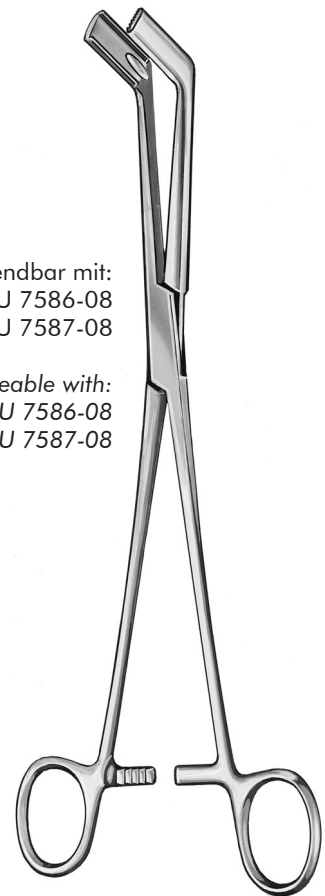

23 cm / 9"
RU 7586-00

Anlegezange /Setting forceps



Lahey
15 cm / 6"
RU 6280-15
Kropffasszange
Goitre grasping forceps



Allis
15 cm / 6"
Zähne 4:5 **RU 6500-15**
teeth 5:6 **RU 6502-15**



Czerny
20,5 cm / 8¼"
RU 7175-20

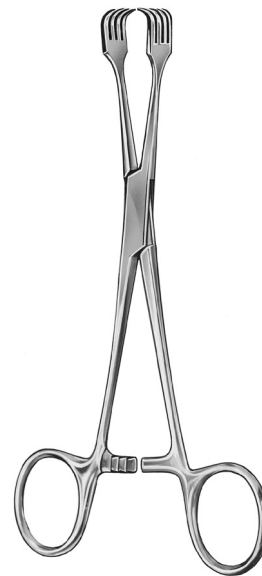

Braun
15,5 cm / 6¼"
RU 7197-16

Anatomische Pinzetten

Dressing forceps

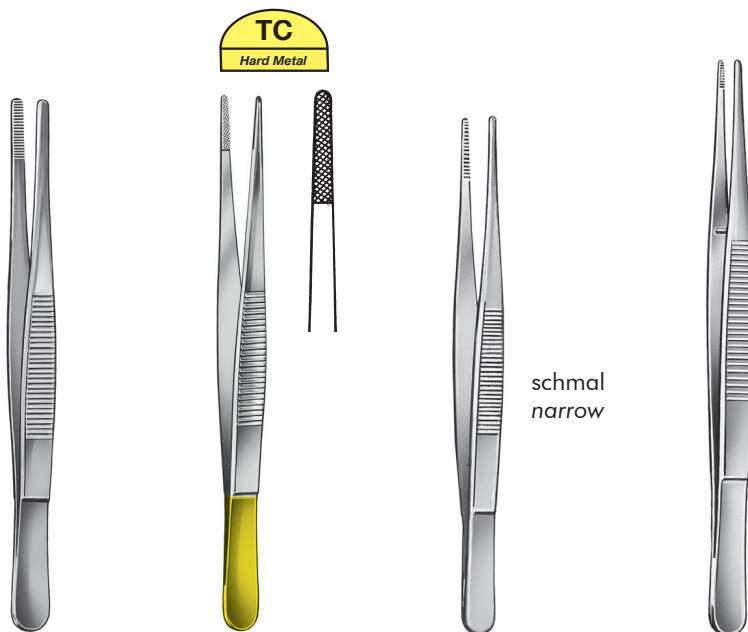

	Standard	Standard		Cottle
10,5 cm / 4 1/4"	RU 4000-10	-	-	-
11,5 cm / 4 1/2"	RU 4000-11	-	RU 4010-11	-
13,0 cm / 5"	RU 4000-13	-	RU 4010-13	-
14,5 cm / 5 3/4"	RU 4000-14	RU 4002-14	RU 4010-14	-
15,0 cm / 6"	RU 4000-15	-	-	RU 4026-15
16,0 cm / 6 1/4"	RU 4000-16	RU 4002-16	RU 4010-16	-
18,0 cm / 7"	RU 4000-18	RU 4002-18	RU 4010-18	-
20,0 cm / 8"	RU 4000-20	RU 4002-20	RU 4010-20	-
25,0 cm / 10"	RU 4000-25	RU 4002-25	RU 4010-25	-

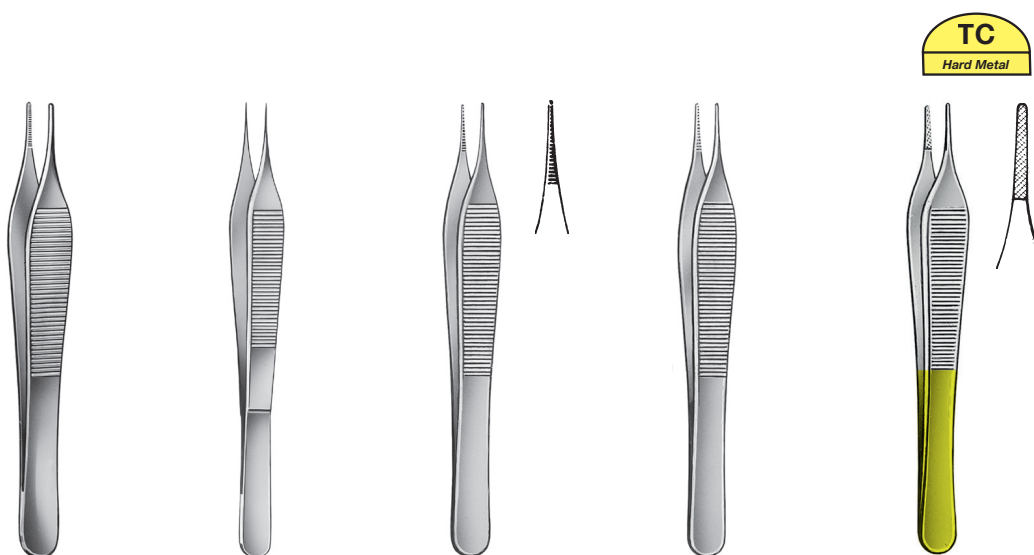

	Ewald	Jacobson-Adson	Mikro-Adson	Adson Standard	Adson
12,0 cm / 4 3/4"	RU 4032-12	RU 4033-12	RU 4034-12	RU 4035-12	RU 4036-12
15,5 cm / 6"	-	RU 4034-15	RU 4035-15	RU 4036-15	-

Anatomische Pinzetten, Tumorfasspinzetten
Dressing forceps, tumor grasping forceps

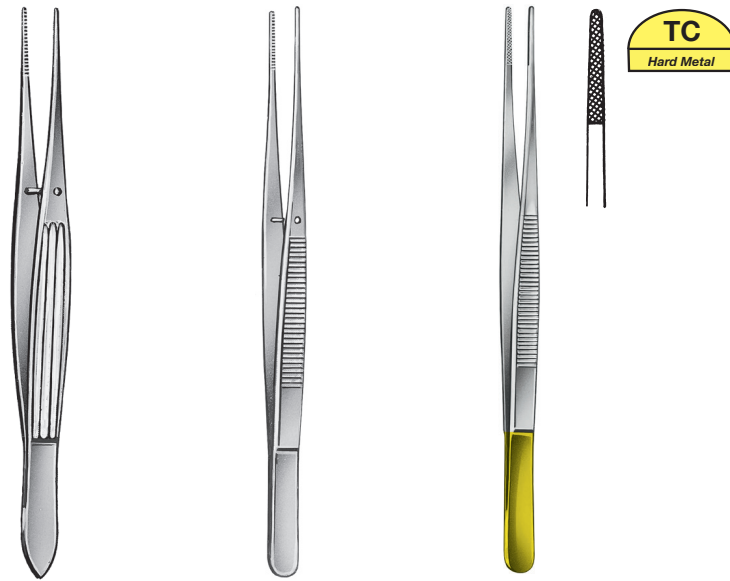

	Mindoe	Semken	Semken
12 cm / 4¾"	–	RU 4040-12	–
15 cm / 6"	RU 4038-15	RU 4040-15	RU 4042-15



Yasargil

	⊙	⊙	⊙
	Ø 3 mm	Ø 5 mm	Ø 7 mm
22 cm / 8¾"	RU 4064-51	RU 4064-52	RU 4064-63
24 cm / 9½"	RU 4064-61	RU 4064-62	
	⊙		
	Ø 3 mm		
22 cm / 8¾"	RU 4064-54		
	⊙		
	Ø 5 mm		
22 cm / 8¾"	RU 4064-57		

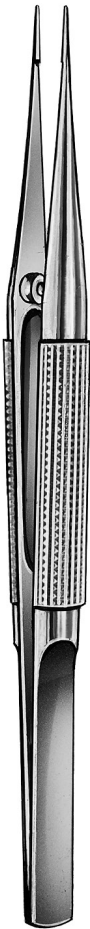

12 cm / 4³/₄"
gerade /straight
RU 4068-12

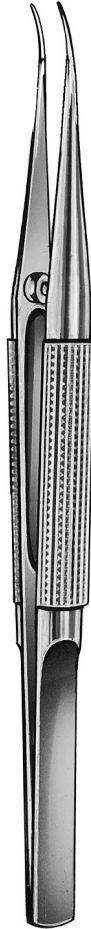

12 cm / 4³/₄"
gebogen /curved
RU 4069-12

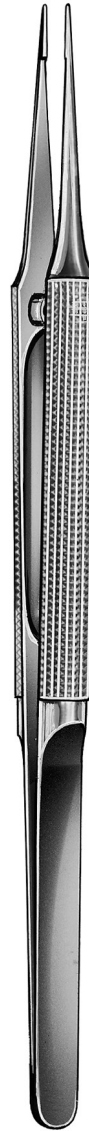

15 cm / 6"
gerade /straight
RU 4068-15

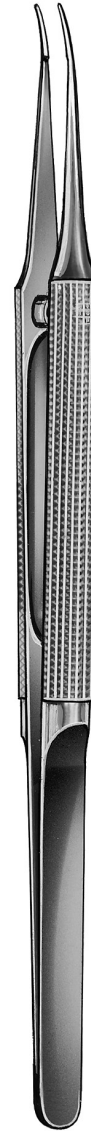

15 cm / 6"
gebogen /curved
RU 4069-15

Mikro-Pinzetten, Tumorfass-, Anatomische Pinzetten
Micro-tweezers, tumour graspers, anatomical tweezers



Gerald
 17,5 cm / 7"
RU 4070-17 RU 4071-17

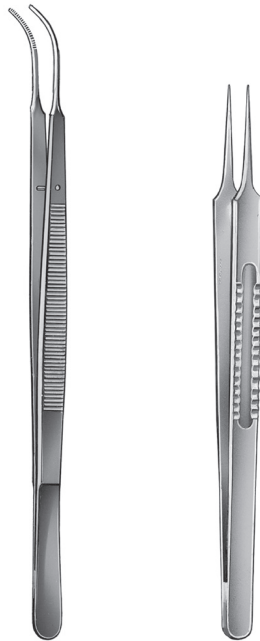

Lazar **RU 4075-08**
 15,5 cm / 6"

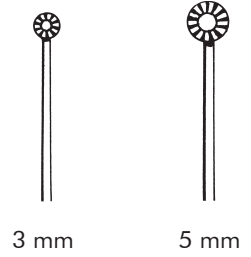
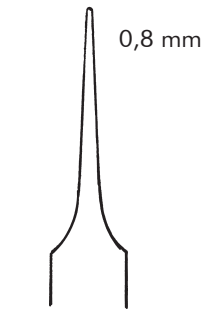
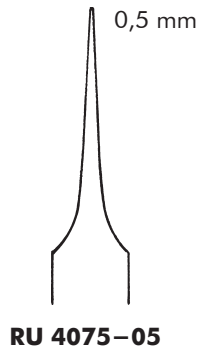

RU 4078-03 RU 4078-04

Yasargil
 22 cm / 8½"
 Maul flach, gezahnt
Jaw flat, serrated



Potts-Smith

18 cm / 7"	RU 4090-18
21 cm / 8¼"	RU 4090-21
25 cm / 10"	RU 4090-25

Potts-Smith

15 cm / 6"	RU 4092-15
18 cm / 7"	RU 4092-18
20 cm / 8"	RU 4092-20
23 cm / 9"	RU 4092-23
25 cm / 10"	RU 4092-25



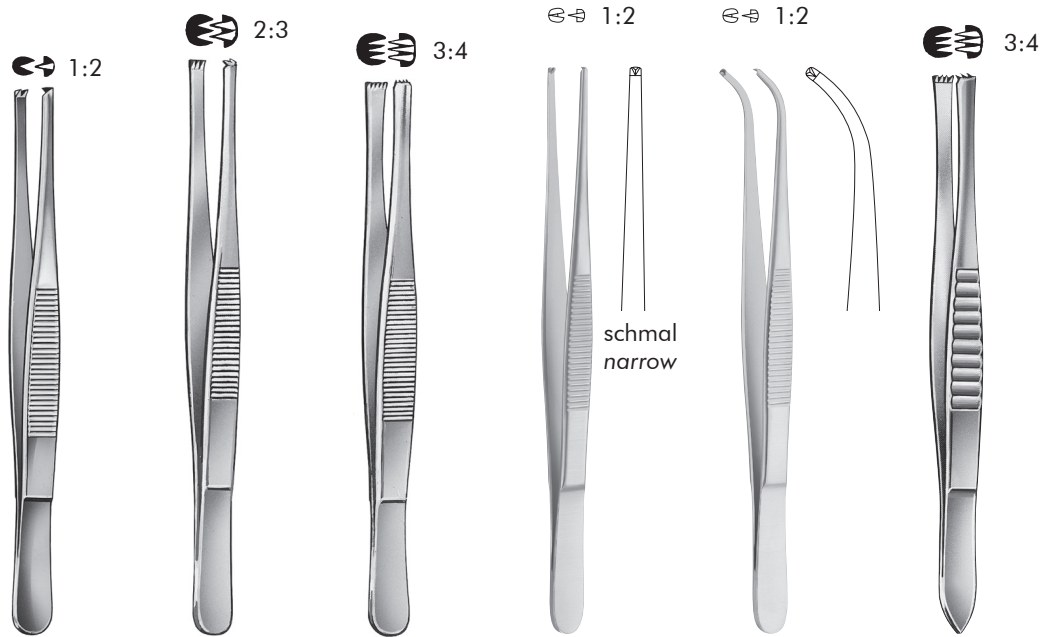

	Standard	Standard	Standard			Modell USA
10,5 cm /4¼"	RU 4100-10	—	—	—	—	—
11,5 cm /4½"	RU 4100-11	—	—	RU 4110-11	—	—
13,0 cm /5"	RU 4100-13	RU 4102-13	—	RU 4110-13	—	—
14,5 cm /5½"	RU 4100-14	RU 4102-14	—	RU 4110-14	RU 4111-14	RU 4123-14
15,0 cm /6"	RU 4100-15	—	—	—	—	—
16,0 cm /6¼"	RU 4100-16	RU 4102-16	RU 4103-16	RU 4110-16	—	—
18,0 cm /7"	RU 4100-18	RU 4102-18	—	RU 4110-18	—	—
20,0 cm /8"	RU 4100-20	RU 4102-20	RU 4103-20	RU 4110-20	—	—
25,0 cm /10"	RU 4100-25	RU 4102-25	—	RU 4110-25	—	—

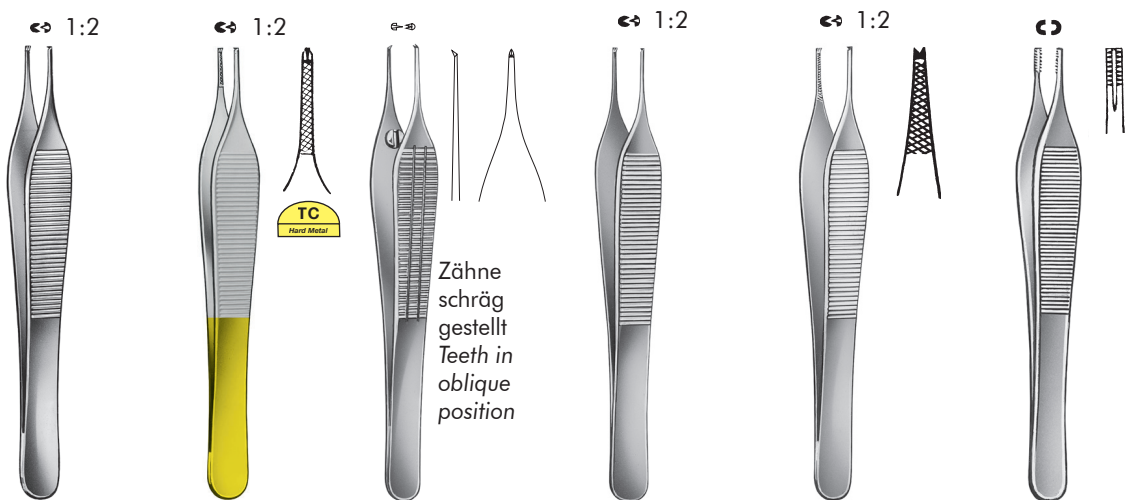

	Micro-Adson			Adson-Standard	Adson	Adson-Brown
12,0 cm /4¾"	RU 4130-12	RU 4130-22	RU 4131-12	RU 4135-12	RU 4136-12	RU 4137-12
15,5 cm /6"	RU 4130-15	RU 4130-25	—	RU 4135-15	—	RU 4137-15

Chirurgische Pinzetten
Tissue forceps



↔ 1:2

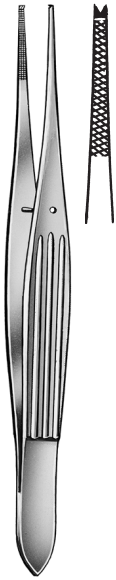

M Indoe
 15 cm / 6"
RU 4138-75

↔ 1:2



Gillies
 15 cm / 6"
RU 4138-15

↔ 1:2



Semken

12 cm / 4¾"	RU 4140-12
15 cm / 6"	RU 4140-15

↔ 2:3



Semken

RU 4142-12
RU 4142-15

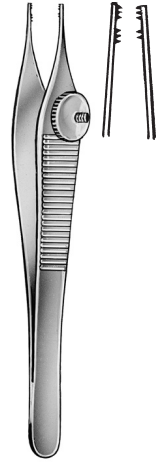

Derlacki

RU 4143-12
—

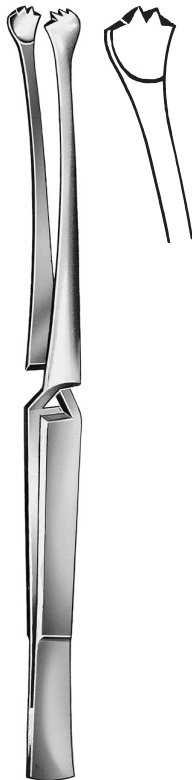

Marschik

15 cm / 6"	—
18 cm / 7"	—
20 cm / 8"	—
22 cm / 8¾"	RU 4146-22



Waugh

RU 4155-15
RU 4155-18
RU 4155-20
RU 4155-25



Gerald

—
RU 4170-18
—
—



—
RU 4171-18
—
—

Uhrmacherpinzetten, Feine Pinzetten
Watchmaker's forceps, fine forceps



0,3 mm



No. 3

11,5 cm / 4½"
RU 4240-03

0,2 mm



No. 4

11 cm / 4½"
RU 4240-04

0,15 mm



No. 5

11 cm / 4½"
RU 4240-05

0,3 mm



No. 6

11 cm / 4½"
RU 4240-06

0,2 mm



No. 7

11,5 cm / 4½"
RU 4240-07

↔ 1:2 0,4 mm

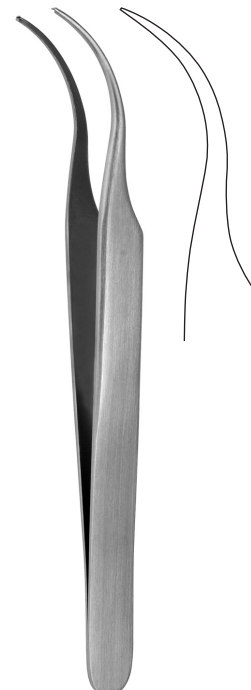

No. 8

11,5 cm / 4½"
RU 4240-08



10,5 cm / 4¼"

RU 4250-10



RU 4251-10



RU 4260-10



RU 4261-10

Splitterpinzetten, Atraumatische Pinzetten
Splinter forceps, atraumatic tissue forceps

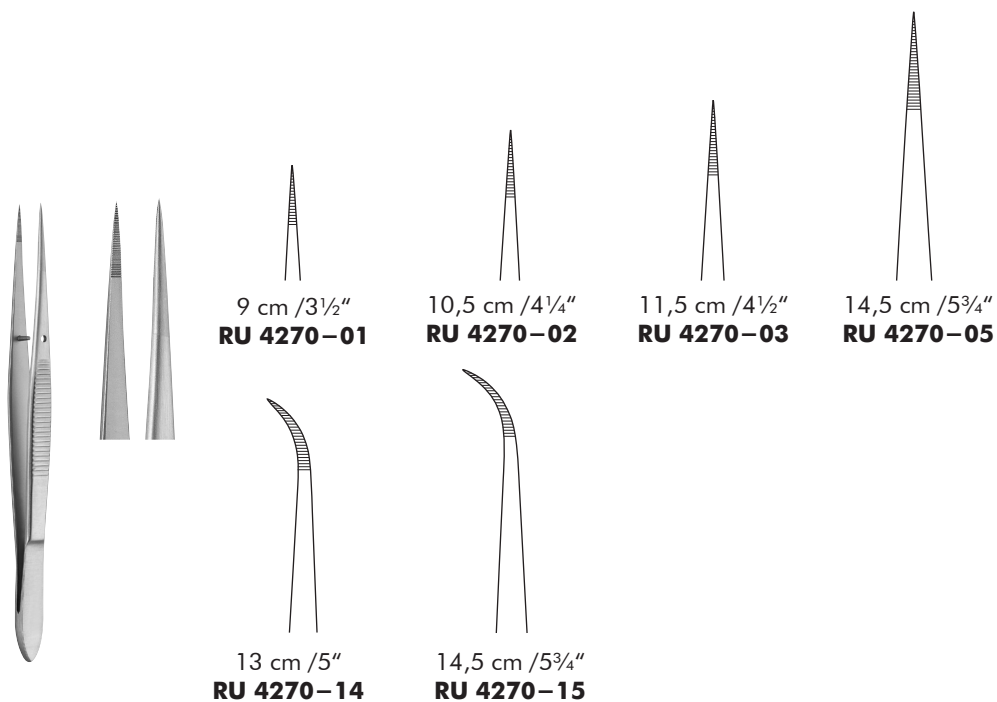

Maulbreite width of jaw	1,5 mm	2,0 mm	2,7 mm
16 cm / 6¼"	RU 7580-16	RU 7581-16	RU 7582-16
20 cm / 8"	RU 7580-20	RU 7581-20	RU 7582-20

De Bakey



2,0 mm	RU 7584-16
	RU 7584-20

De Bakey

Atraumatische-, Ohr- und Nasenpinzetten, Bulldogklemmen
Atraumatic forceps and bulldog clamps, aural and nasal forceps



DEBAKEY

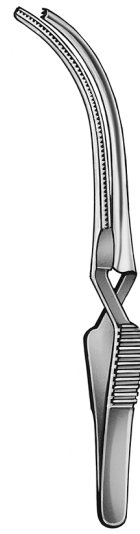
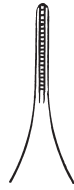

Adson

12 cm / 4³/₄" **RU 7585-12**
 15 cm / 6" **RU 7585-15**

RU 7586-07	8 cm / 3"	RU 7587-07
RU 7586-08	9 cm / 3 ¹ / ₂ "	RU 7587-08

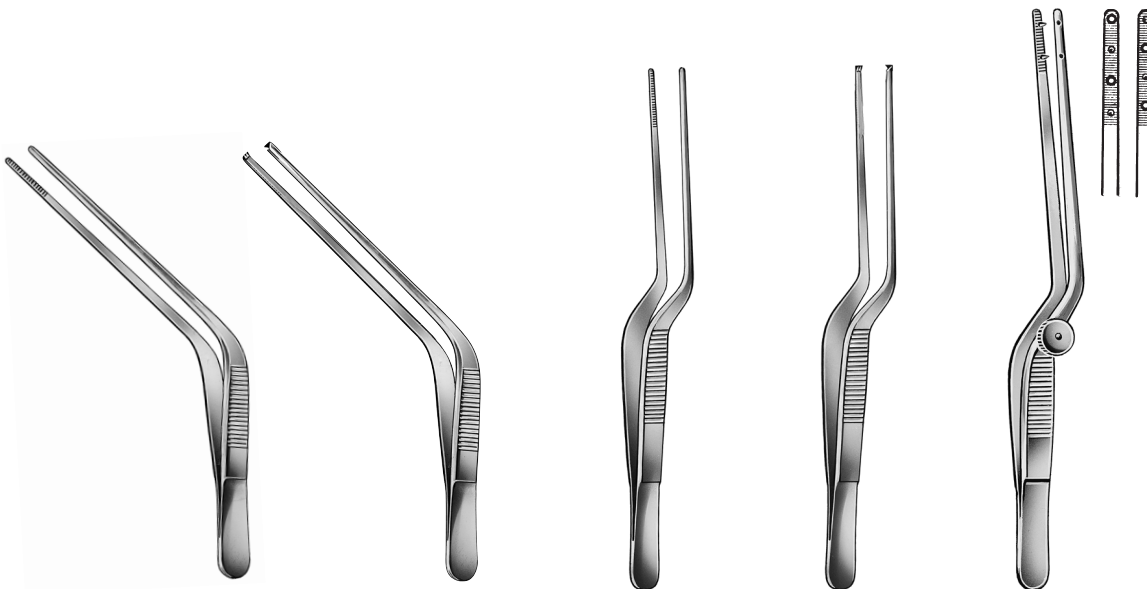

**Troeltsch
(Wilde)**

Troeltsch

Lucae

Lucae

Cottle

11 cm / 4 ¹ / ₂ "	RU 7860-11	—	—	—	—
12 cm / 4 ³ / ₄ "	RU 7860-12	RU 7861-12	—	—	—
14 cm / 5 ¹ / ₂ "	—	RU 7862-14	RU 7862-24	RU 7863-14	—
15 cm / 6"	RU 7860-15	—	—	—	RU 7863-15
18 cm / 7"	RU 7860-18	—	—	—	—

Nasen-, Columella- und Chirurgische Pinzetten
Nasal forceps, columella forceps, tissue forceps

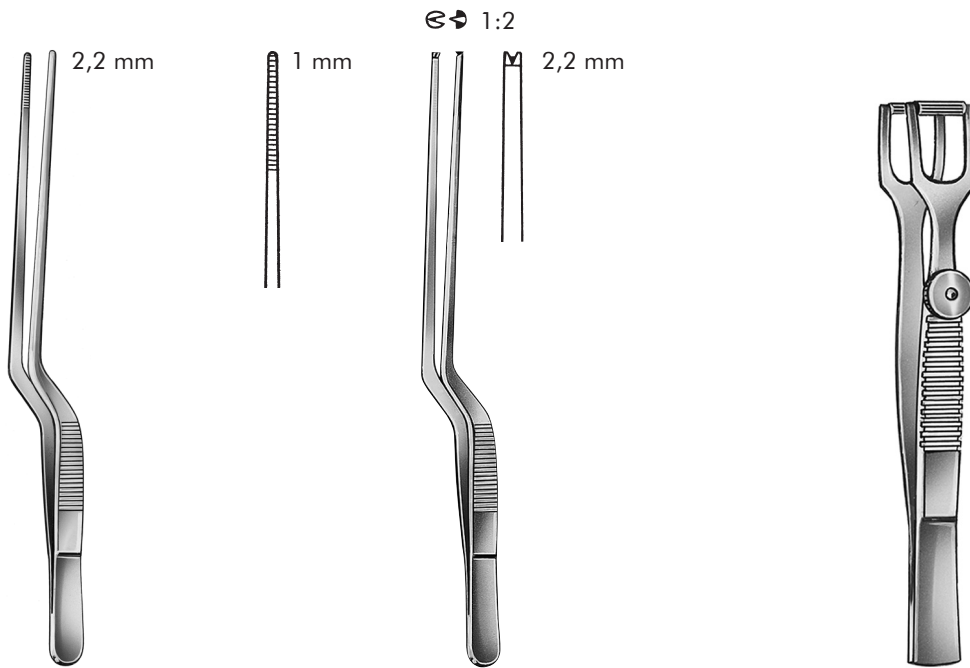

	Jansen (Gruenwald)	Jansen (Fine)	Jansen
16 cm / 6¼"	RU 7864-16	RU 7864-26	RU 7865-16
18 cm / 7"	RU 7864-18	RU 7864-28	—
20 cm / 8"	RU 7864-20	RU 7864-30	RU 7865-20

Cottle
 10 cm / 4"
RU 8312-10



Graefe
 11 cm / 4½"

ohne Schloß
without spring catch

RU 9942-11

mit Schloß
with spring catch

RU 9943-11

Zahnbreite 0,5 mm
width of teeth



Castroviejo
 10 cm / 4"
RU 9964-05



Cushing
 19 cm / 7½"



RU 4426-01



RU 4426-02



Gillies
 18 cm / 7"
RU 6296-01



Fig. 1



Gillies
 18 cm / 7"
RU 6296-02



Fig. 2

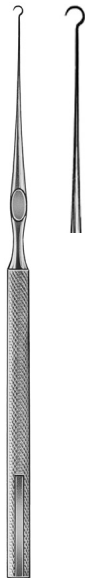

Kilner
 15 cm / 6"
RU 6297-15



Frazier
RU 6392-13 13 cm / 5"
RU 6392-18 18 cm / 7"



scharf
 sharp



Frazier
RU 6393-13 13 cm / 5"
RU 6393-18 18 cm / 7"

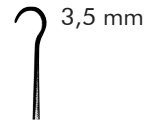

stumpf
 blunt

Wund-, Haut- und Trachealhäkchen
Wound and trachea hooks

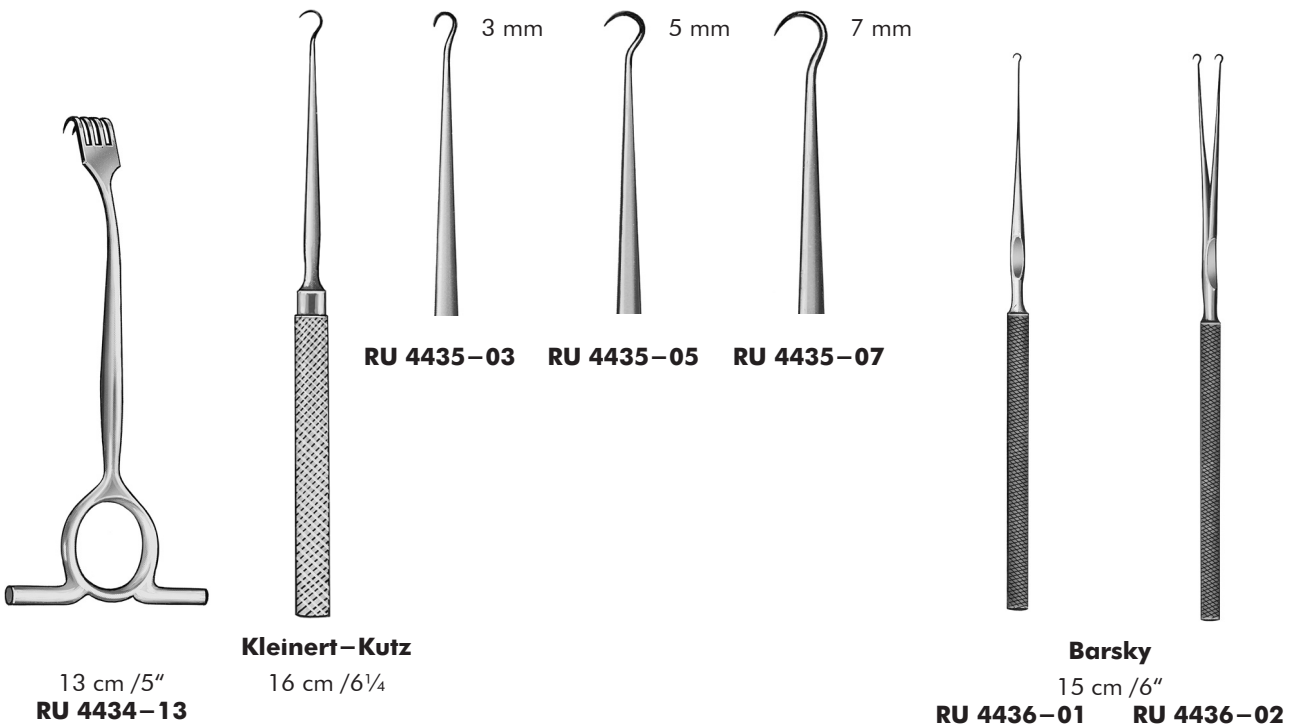
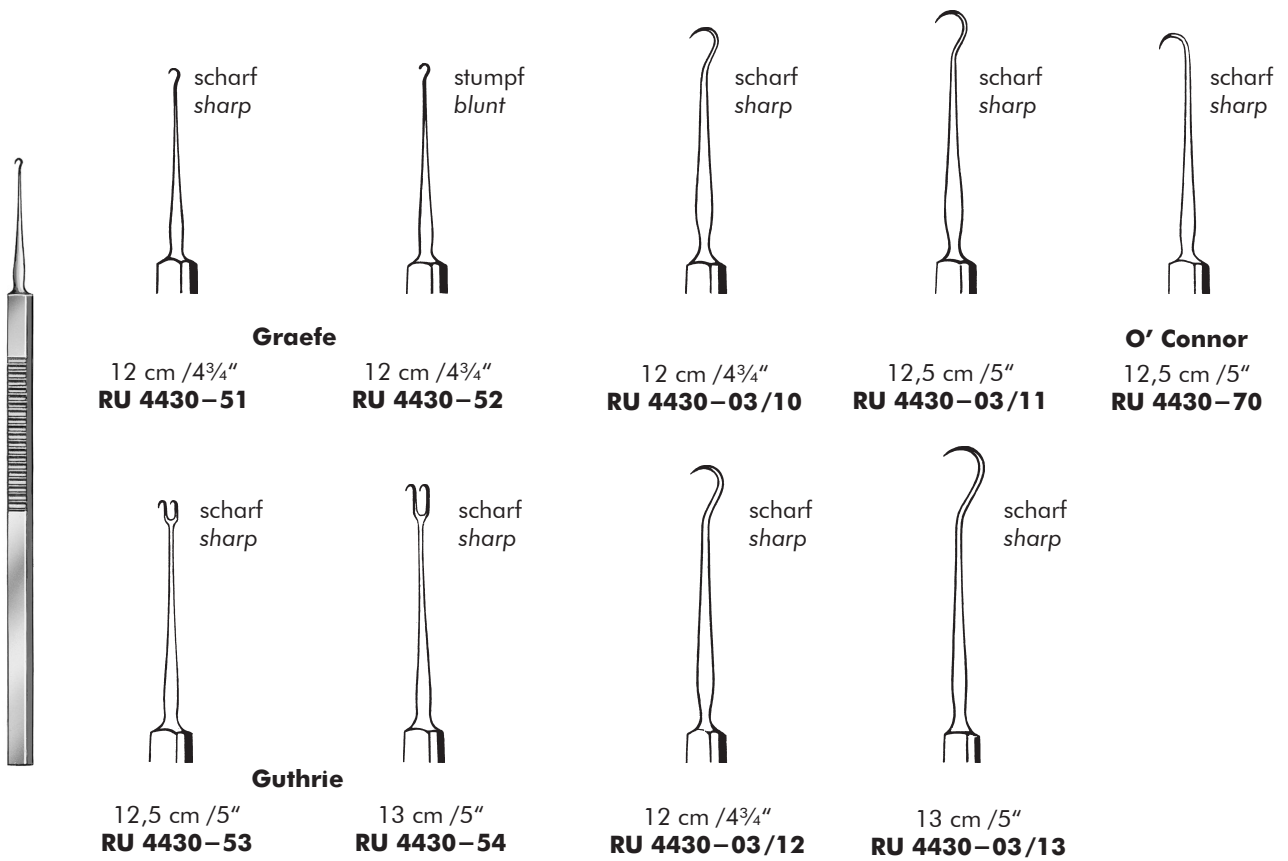

Wund- und Trachealhäkchen
Wound and trachea hooks

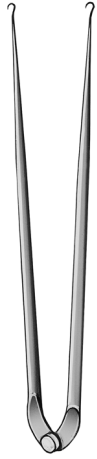

Humby
 11,5 cm / 4½"
RU 4437-00



Lukens
 17 cm / 6¾"
RU 4438-17



Jackson
 17 cm / 6¾"
RU 4439-17



Standard
 16 cm / 6¼"



scharf
sharp

RU 4460-01



RU 4460-02



RU 4460-03



RU 4460-04



stumpf
blunt

RU 4461-01



RU 4461-02



RU 4461-03



RU 4461-04

fein
fine



16 cm / 6¼"



scharf
sharp

RU 4462-01



RU 4462-02



RU 4462-03



RU 4462-04



stumpf
blunt

RU 4463-01



RU 4463-02



RU 4463-03



RU 4463-04



Jackson
 13 cm / 5"
RU 4468-13



Bergmann
 14 cm / 5½"
RU 4469-14



Meyerding
 18 cm / 7"



18 x 7 mm
RU 4470-01



16 x 5 mm
RU 4470-02



10 x 3 mm
RU 4470-04



7 x 4 mm
RU 4470-05



Iterson
 16 cm / 6¼"



RU 4471-01



RU 4471-02

Trachealhäkchen, Wundhaken
Trachea hooks, retractors



scharf
sharp

RU 4472-02



stumpf
blunt

RU 4473-02



RU 4472-03



RU 4473-03



RU 4472-04



RU 4473-04



RU 4472-06



RU 4473-06



Volkman

11,5 cm / 4½"

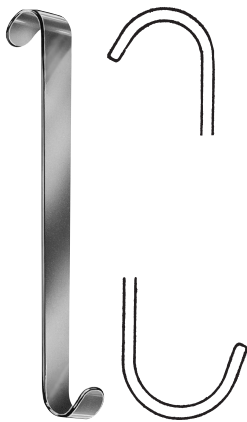

Luer

11 cm / 4½"
RU 4479-11



Rose

13 cm / 5"
RU 4477-13



scharf
sharp

RU 4486-01

stumpf
blunt

RU 4486-02

Senn-Miller

16 cm / 6¼"

Wundhaken
Retractors

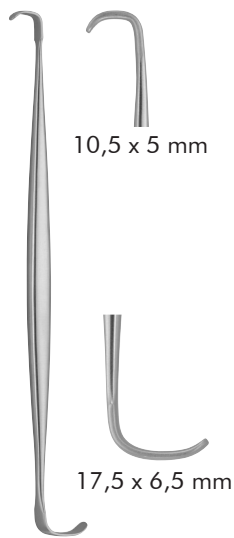

Ragnell-Davis
14 cm / 5½"
RU 4488-14

Langenbeck-Green
16 cm / 6¼"



Rous



Baby-Rous

Satz /set			RU 4492-00
14 cm / 5½"	Fig. 1	21x22 + 29x29 mm	RU 4492-01
15 cm / 6"	Fig. 2	24x26 + 37x35 mm	RU 4492-02
17 cm / 6¾"	Fig. 3	27x29 + 42x35 mm	RU 4492-03

13 cm / 5"
RU 4492-13



30 x 19 mm



33 x 25 mm
Kilner
15 cm / 6"
RU 4492-19

35 x 29 mm



40 x 35 mm
Kilner
15 cm / 6"
RU 4492-20

30 x 18 mm



25 x 10 mm
Hajek
16,5 cm / 6½"
RU 4492-21



Satz
set

Farabeuf
12 cm / 4¾"
RU 4497-12



Satz
set

Farabeuf
15 cm / 6"
RU 4497-15

Wundhaken
Retractors

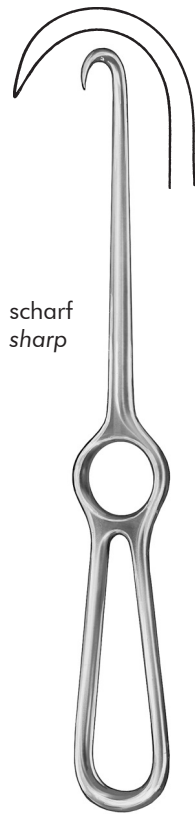

scharf
sharp

Volkmann
22 cm / 8¾"
RU 4500-01

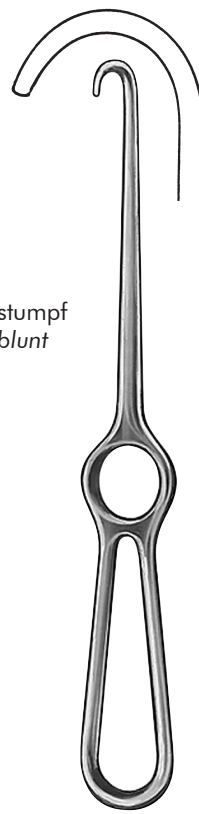

stumpf
blunt

Volkmann
22 cm / 8¾"
RU 4501-01



scharf
sharp

stumpf
blunt

halbscharf
semi-sharp

Volkmann
22 cm / 8¾"

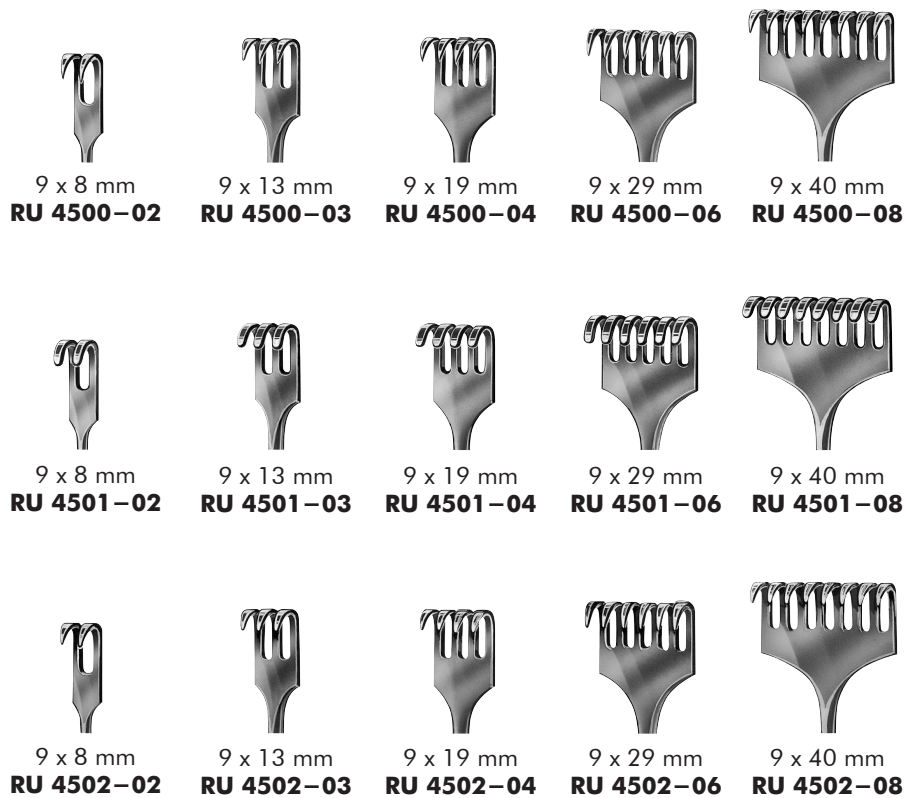

Wundhaken
Retractors

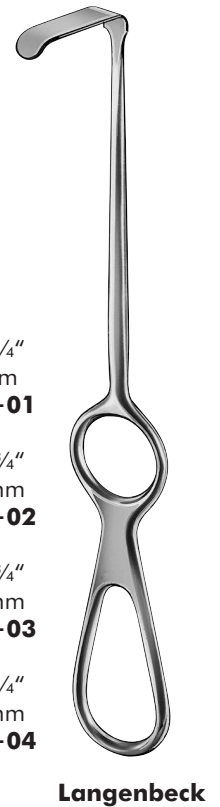
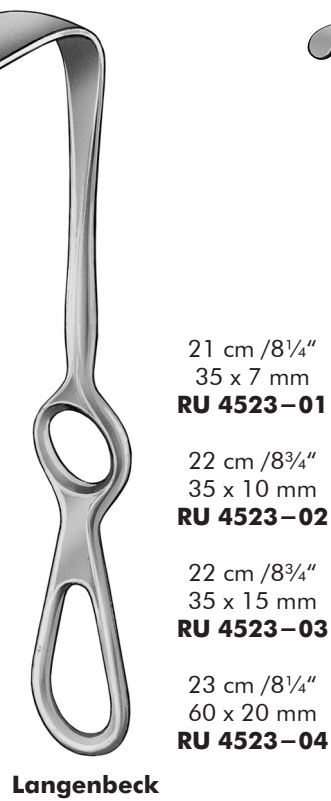
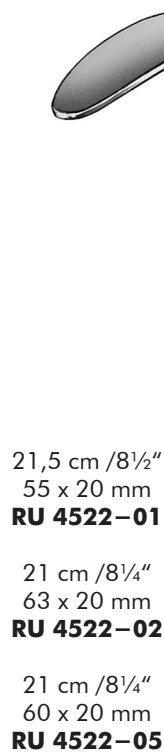
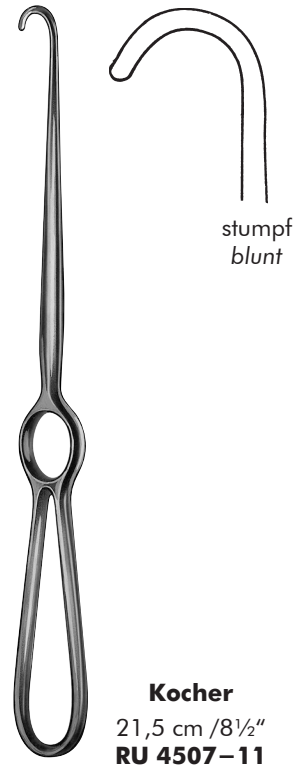

Wundhaken
Retractors



Langenbeck
21 cm / 8¼"

	21 cm / 8¼"	22 cm / 8¾"
RU 4530-01	30 x 11 mm	RU 4531-01
RU 4530-02	30 x 14 mm	—
RU 4530-03	33 x 14 mm	—
RU 4530-04	30 x 16 mm	—
RU 4530-05	40 x 11 mm	RU 4531-05
RU 4530-06	42 x 13 mm	RU 4531-06
RU 4530-07	50 x 11 mm	—



Langenbeck
22 cm / 8¾"



19 x 12 mm
RU 4536-01

21 x 15 mm
RU 4536-02

Kocher
19 cm / 7½"

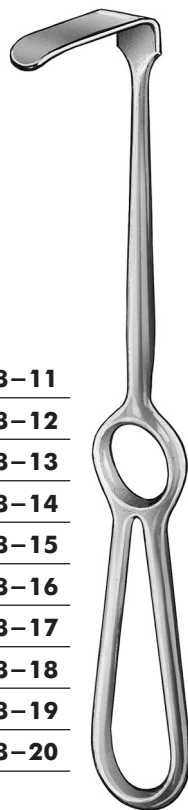

Kocher-Langenbeck
21,5 cm / 8½"

25 x 6 mm	RU 4538-11
25 x 8 mm	RU 4538-12
35 x 8 mm	RU 4538-13
35 x 11 mm	RU 4538-14
35 x 15 mm	RU 4538-15
40 x 11 mm	RU 4538-16
55 x 11 mm	RU 4538-17
70 x 14 mm	RU 4538-18
80 x 12 mm	RU 4538-19
80 x 16 mm	RU 4538-20



14 x 17 mm
21,5 cm / 8½"
RU 4551-01



20 x 22 mm
22 cm / 8¾"
RU 4551-02



26 x 30 mm
23,5 cm / 9¼"
RU 4551-03



Middeldorpf

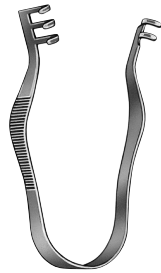

Finsen
scharf /sharp

7 cm /2¾" **RU 4640-07**

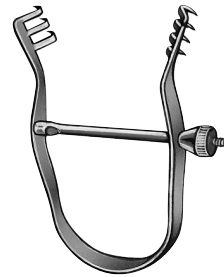

Finsen
scharf /sharp

RU 4642-07

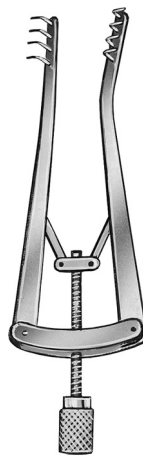

Alm

	scharf /sharp	stumpf /blunt
7 cm /2¾"	RU 4650-07	RU 4651-07
10 cm /4"	RU 4651-10	—

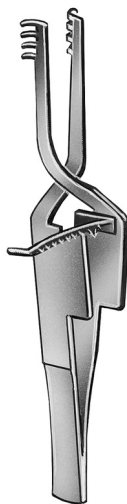

10 cm /4"

scharf /sharp	stumpf /blunt
RU 4655-00	RU 4655-10



Jansen

10,5 cm /4¼"

scharf /sharp	stumpf /blunt
RU 4680-10	RU 4681-10



Kieferhöhlensperrer
Antrum retractor

rechtes Blatt voll,
scharf gezahnt
solid blade right
coarse serrated

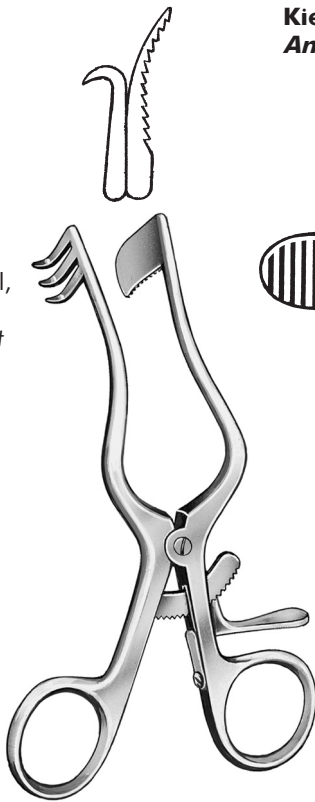

Perkins
13 cm / 5"
RU 4688-01

linkes Blatt voll,
scharf gezahnt
solid blade left
coarse serrated

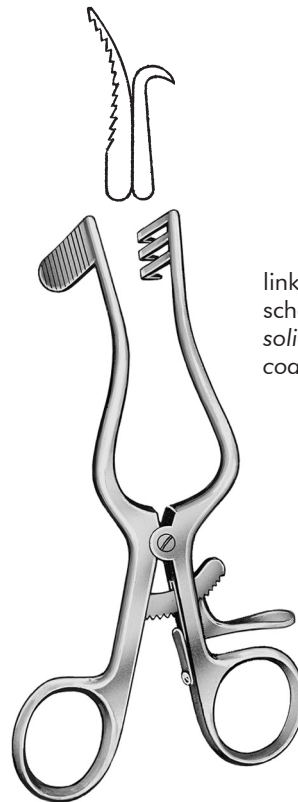

Perkins
13 cm / 5"
RU 4688-02

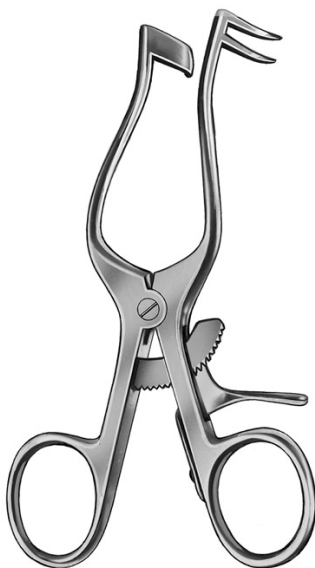

Plester
11 cm / 4½"
RU 4690-01



Plester
11 cm / 4½"
RU 4690-02

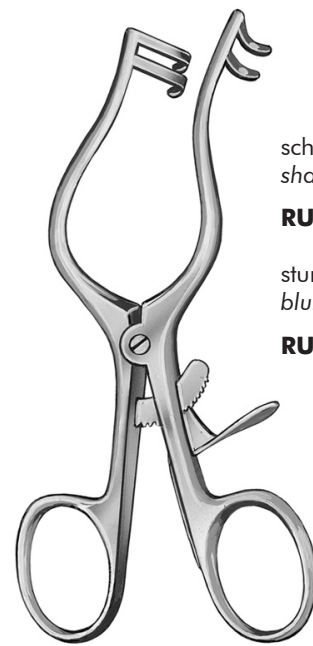

scharf
sharp
RU 4691-01

stumpf
blunt
RU 4691-02

Plester
13 cm / 5"

Wundsperrer
Retractors



verstellbar /adjustable



17 cm /6¾"

Blatt /blade
25 x 17 mm **RU 4694-05**



17 cm /6¾"

RU 4694-06

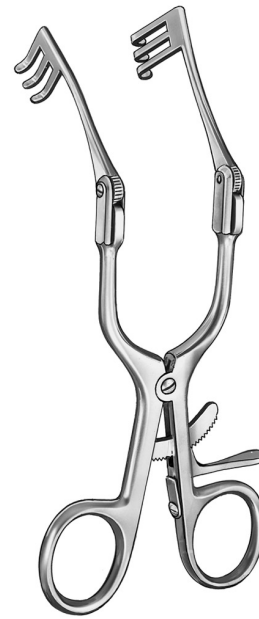

Fisch
17 cm /6¾"

RU 4694-11



Weitlaner

scharf
sharp stumpf
blunt

10,5 cm /4¼" **RU 4700-10** **RU 4701-10**

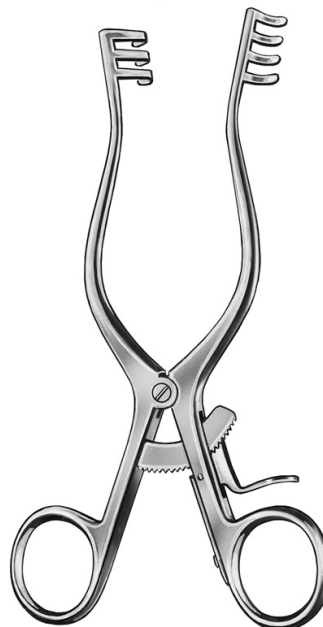

Weitlaner

scharf
sharp stumpf
blunt

13,0 cm /5" — — **RU 4700-13** **RU 4701-13** **RU 4710-13** **RU 4711-13**

16,5 cm /6½" — — **RU 4700-16** **RU 4701-16** **RU 4710-16** **RU 4711-16**



Weitlaner-Wullstein

scharf
sharp stumpf
blunt



Mollison
 15 cm / 6"
RU 4714-15

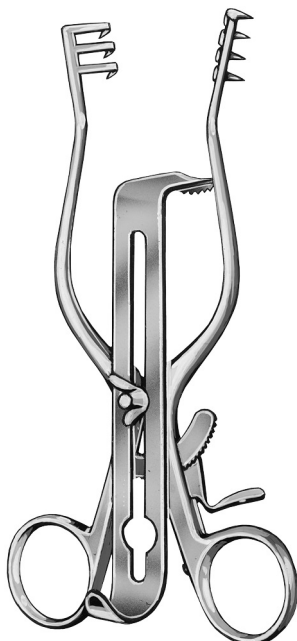

Henley
 16,5 cm / 6½"
 scharf /sharp stumpf /blunt
RU 4718-00 RU 4718-01
 komplett mit 3 Mittelvalven
 complete with 3 central blades

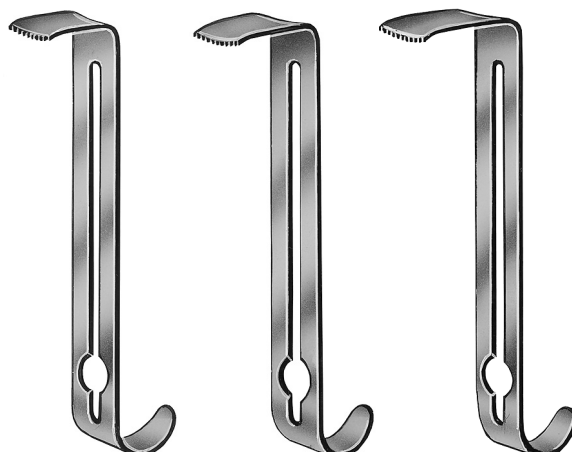

16 x 19 mm 16 x 25 mm 16 x 32 mm
RU 4718-19 RU 4718-25 RU 4718-32

Mittelvalven, allein
 Central blades, only

Wundsperrer, Wangen- und Lippenhalter
Retractors, cheek and lip retractor

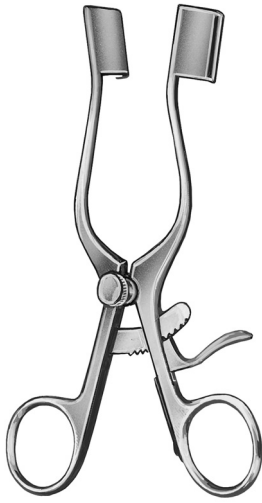

Weitlaner-Baby
13 cm / 5"
RU 4719-13

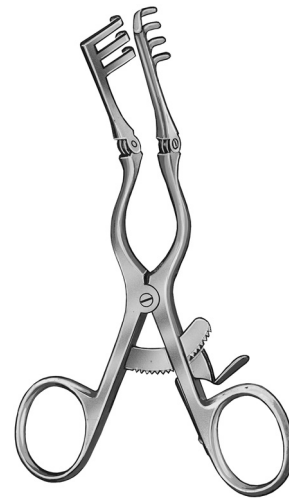

Cone
(Adson-Baby)
13 cm / 5"
verstellbar / adjustable
scharf / sharp stumpf / blunt
RU 4722-13 RU 4723-13

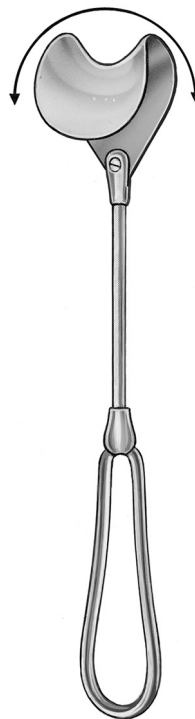

19 cm / 7½"
RU 8420-19
Wangen- und Lippenhalter
Cheek and lip retractors



No. 3
RU 4850-03



No. 4
RU 4850-04



No. 7
RU 4850-07



No. 8
RU 4850-08



No. 9
RU 4850-09



No. 3 L
RU 4850-31



No. 4 L
RU 4850-41

Skalpellklingen
Scalpel blades



Packung à 100 Stk.
Package of 100 pcs.



unsteril /non-sterile
steril /sterile

Fig. 10 **RU 4851-10** Fig. 11 **RU 4851-11** Fig. 12 **RU 4851-12** Fig. 13 **RU 4851-13** Fig. 15 **RU 4851-15**
RU 4852-10 **RU 4852-11** **RU 4852-12** — **RU 4852-15**

passend zu den Griffen /for handles: RU 4850-03, RU 4850-07, RU 4850-08, RU 4850-31

Packung à 100 Stk.
Package of 100 pcs.



unsteril /non-sterile
steril /sterile

Fig.18 **RU 4851-18** Fig.19 **RU 4851-19** Fig. 20 **RU 4851-20** Fig. 21 **RU 4851-21**
RU 4852-18 **RU 4852-19** **RU 4852-20** **RU 4852-21**

passend zu den Griffen /for handles: RU 4850-04, RU 4850-09, RU 4850-41

Packung à 100 Stk.
Package of 100 pcs.

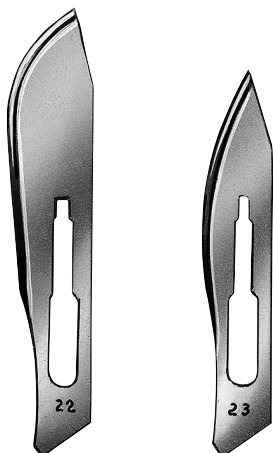

unsteril /non-sterile
steril /sterile

Fig. 22 **RU 4851-22** Fig. 23 **RU 4851-23**
RU 4852-22 **RU 4852-23**

passend zu den Griffen /for handles: RU 4850-04, RU 4850-09, RU 4850-41

Mini-klingen, Skalpelli-griff
Mini blades, scalpel handle



Packung à 10 Stk.
Package of 10 pcs.
steril /sterile



Fig. 64

RU 4853-64



Fig. 65

RU 4853-65



Fig. 67

RU 4853-67



Fig. 69

RU 4853-69

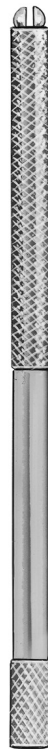

10 cm /4"
13 cm /5"
15 cm /6"

RU 4853-33
RU 4853-34
RU 4853-35

Griff für Mini-Skalpellklingen
Handle for mini scalpel blades

Skalpellgriffe für Mini-Klingen
Scalpel handles for mini blades



Caspar
18 cm / 7"
RU 4854-03



20 cm / 8"
RU 4854-04



Landolt
21 cm / 8¼"
RU 4854-10

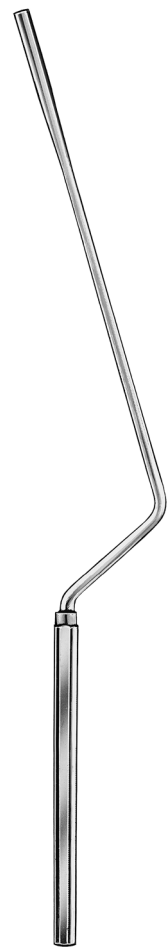

Landolt
25 cm / 10"
RU 4854-11

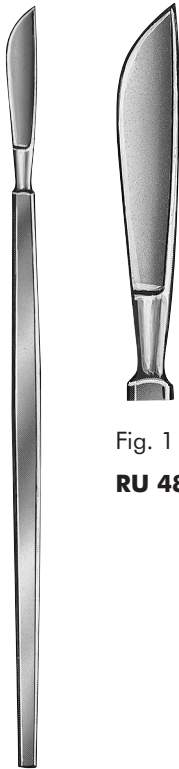

Fig. 1
RU 4870-01

Simon
20 cm / 8"

Sonden, Pflasterspatel, Watteträger
Probes, plaster spatulas, cotton applicators



	Ø 1,0 mm	Ø 1,5 mm		
11,5 cm / 4½"	RU 4900-11	RU 4901-11	RU 4910-11	—
13,0 cm / 5"	RU 4900-13	RU 4901-13	RU 4910-13	RU 4914-13
14,5 cm / 5¾"	RU 4900-14	RU 4901-14	RU 4910-14	RU 4914-14

Stacke
 Ø 1,0 mm
 10,5 cm / 4¼"
RU 4916-10

Pflasterspatel
 Plaster spatulas



13 cm / 5"
RU 4920-13

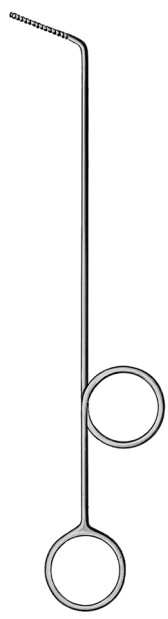

Hartmann
 22 cm / 8½"
RU 4921-01

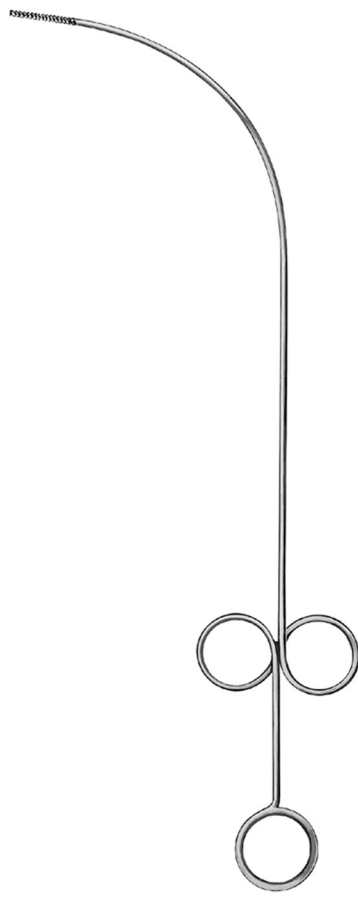

Fein
 28 cm / 11"
RU 4922-28

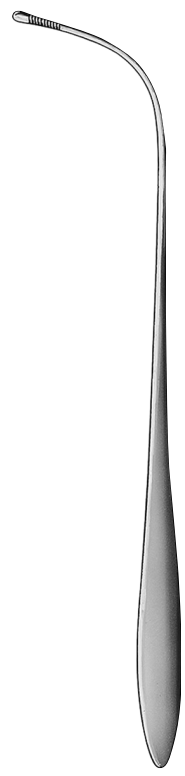

Killian
 25 cm / 10"
RU 4922-50



Seiffert
 14 cm / 5½"
 Ø 0,5 mm
RU 4914-14

Myrtenblattsonde
 Myrtle blade probe



Wilder

9,5 cm / 3¾"	RU 9630-11	RU 9630-12	RU 9630-13
11 cm / 4¼"	RU 9630-01	RU 9630-02	RU 9630-03



CASTROVIEJO
 13,5 cm / 5¼"
RU 9632-12

zylindrisch
 cylindrical

Fig.	Bowman
0000 /000	RU 9651-04
000 /00	RU 9651-03
00 /0	RU 9651-02
0 /1	RU 9651-01
1 /2	RU 9651-12
2 /3	RU 9651-23
3 /4	RU 9651-34
4 /5	RU 9651-45
5 /6	RU 9651-56
6 /7	RU 9651-67
7 /8	RU 9651-78



geknöpft
 button end

Fig.	Bowman
0000 /000	RU 9652-04
000 /00	RU 9652-03
00 /0	RU 9652-02
0 /1	RU 9652-01
1 /2	RU 9652-12
2 /3	RU 9652-23
3 /4	RU 9652-34
4 /5	RU 9652-45
5 /6	RU 9652-56
6 /7	RU 9652-67
7 /8	RU 9652-78





Universal

	Ø 1,2 mm	Ø 1,5 mm	Ø 1,7 mm
12,5 cm / 5"	RU 4930-12	—	—
16,0 cm / 6¼"	RU 4930-16	—	—
18,0 cm / 7"	—	RU 4931-18	RU 4932-18



Jobson-Horne

18 cm / 7"
RU 4933-02



Frohn

Ø 1,0 mm

12 cm / 4¾"	RU 4934-01
14 cm / 5½"	RU 4934-02
16 cm / 6¼"	RU 4934-03



Farell
(Farell-Lathbury)

rund
round



dreikant
triangular



14 cm / 5¾"	Ø 0,9 mm	RU 4935-14	—
16 cm / 6¼"	Ø 1,1 mm	RU 4935-16	RU 4936-16

Kaltlicht-Stirnlampen

Fiber optic headlights



Clar

Kaltlicht Stirnlampe Clar 73

Klassische HNO-Stirnlampe mit kleinem Spiegelreflektor. Untere Spiegelausbuchtung zur optimalen, monokularen Sicht. Komplett mit 2300 mm ultraleichtem F /O-Kabel und ledergepolstertem Stirnreif mit Kopfbügel und zentraler Schnellverstellung. Ohne Adapter für Lichtquelle.

Fiber Optic Headlight Clar 73

Classical ENT-headlight with small mirror. Lower hollow at mirror for optimal, monocular view. Complete with ultra light 2300mm fiber optic light guide and easily adjustable leather bolstered headband with cross band. Without fitting for light source.

RU 5155-20

In der hitzefesten Variante können diese Stirnleuchten auch mit Hochleistungslichtquellen 180 Watt Xenon und 300 Watt Xenon benutzt werden.

Bitte angeben!

The heat resistant model can be used with one of the high power xenon short arc light sources like 180 W Xenon and 300 W Xenon.

Please specify!



Kaltlicht-Stirnlampen

Fiber optic headlights



RU 5158-20 Miniatur-Stirnlampe

OP-Version der Miniaturstirnleuchte. Der Faserbündelquerschnitt von 3,5 mm und das 2-fache Linsensystem sorgen für einen kleinen und homogenen Lichtfleck. Lieferung ohne Adapter für Lichtquelle.

Miniature headlight

Operation theatre version of the miniature head light. The fiber bundle diameter of 3.5 mm as well as the double lens system provide a small and homogenous light spot. Delivery without fitting for light source.

RU 5158-21 Wie 5158-20, jedoch 90° abgewinkeltes Kabelende.

Same as 5128-20 but cable end 90° angled.



RU 5158-20



RU 5158-21

In der hitzefesten Variante können diese Stirnleuchten auch mit Hochleistungslichtquellen 180 Watt Xenon und 300 Watt Xenon benutzt werden.

Bitte angeben!

The heat resistant model can be used with one of the high power xenon short arc light sources like 180 W Xenon and 300 W Xenon.

Please indicate!

RU 5158-40 Miniatur-Stirnlampe mit Kopfbügelstirnband

Fiberoptische Miniaturstirnleuchte für den OP-Bereich. Maximales Sichtfeld durch Miniatur-Hochleistungs-Optik. Der Faserbündelquerschnitt von 3,5 mm und die verstellbare Kleinoptik mit 2-fachem Linsensystem gewährleisten einen sehr hellen und homogenen Lichtfleck. Das ledergepolsterte Stirnband mit Kopfbügel und zentraler Einhandverstellung sorgt für bequemen Sitz, auch über längere Zeit. Lieferung ohne Adapter für Lichtquelle.

Miniature headlight with cross band headband

Fiber optic miniature headlight for operation theatre. Extra large field of view due to miniature high-performance optic. The fiber bundle of 3.5 mm Ø as well as the adjustable double lens system provide a small and homogenous light spot. The leather bolstered headband with cross band is adjustable centrally with only one hand. It is comfortable also during long period of use. Delivery without fitting for light source.

RU 5158-41 Wie 5158-40, jedoch 90° abgewinkeltes Kabelende.

Same as 5158-40 but cable end 90° angled.



RU 5158-40



RU 5158-41

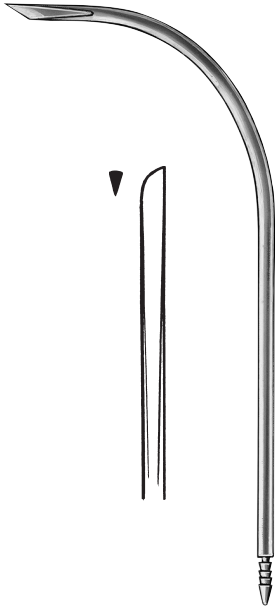

Charr /Fr.	
8	RU 5291-28
10	RU 5291-30
12	RU 5291-32
14	RU 5291-34



Charr /Fr.	
8	RU 5291-48
10	RU 5291-50
12	RU 5291-52
14	RU 5291-54



Magill

15 cm /6"
für Kleinkinder /for infants
RU 5295-15

20 cm /8"
für Kinder /for children
RU 5295-20

25 cm /10"
für Erwachsene /for adults
RU 5295-25

Flach- und Hohlmeißel, Osteotome
Bone chisels, gouges, osteotomes



Breite width			
mm		13,5 cm / 5 1/4"	
4	RU 5300-04	RU 5302-04	RU 5304-04
6	RU 5300-06	RU 5302-06	RU 5304-06
8	RU 5300-08	RU 5302-08	RU 5304-08
10	RU 5300-10	RU 5302-10	RU 5304-10
12	RU 5300-12	RU 5302-12	RU 5304-12
14	RU 5300-14	RU 5302-14	RU 5304-14
16	RU 5300-16	RU 5302-16	RU 5304-16
	Osteotome	Flachmeißel	Hohlmeißel
	Osteotome	Bone chisels	Gouges

Breite width	Partsch	Partsch
mm	13,5 cm / 5 1/4"	13,5 cm / 5 1/4"
2	RU 5308-02	RU 5314-02
3	RU 5308-03	RU 5314-03
4	RU 5308-04	RU 5314-04
5	RU 5308-05	RU 5314-05
6	RU 5308-06	—
7	RU 5308-07	RU 5314-07
8	RU 5308-08	—
	Flachmeißel	Hohlmeißel
	Bone chisels	Gouges
Flachmeißel Bone chisels		Hohlmeißel Gouges

Stößel, Osteotome, Flach- und Hohlmeißel
Pestles, osteotomes, bone chisels and gouges



○ Ø 3 mm
RU 5317-03

○ Ø 5 mm
RU 5317-05

16 cm / 6¼"
 Stößel
 Pestle



■ 2,5 mm
RU 5318-02
 ■ 3,5 mm
RU 5318-03

Passow
 12 cm / 4¾"



mm
 2 **RU 5332-02**
 3 **RU 5332-03**
 4 **RU 5332-04**
 6 **RU 5332-06**
 8 **RU 5332-08**
 10 **RU 5332-10**
 12 **RU 5332-12**
 15 **RU 5332-15**

Osteotome
 Osteotome

Mini-Lambotte
 12,5 cm / 5"



RU 5334-04
RU 5334-06
RU 5334-08
RU 5334-10
RU 5334-12

Osteotome
 Osteotome

Mini-Lexer
 18 cm / 7"

mm
 4 **RU 5335-04**
 6 **RU 5335-06**
 8 **RU 5335-08**
 10 **RU 5335-10**
 12 **RU 5335-12**

Hohlmeißel
 Osteotome



Mini-Lexer
 18 cm / 7"

Scharfe Löffel
Bone curettes



Volkmann
17 cm / 6¾"

- | | |
|------|-------------------|
| Fig. | |
| 0000 | RU 5350-40 |
| 000 | RU 5350-30 |
| 00 | RU 5350-20 |
| 0 | RU 5350-10 |
| 1 | RU 5350-01 |
| 2 | RU 5350-02 |
| 3 | RU 5350-03 |
| 4 | RU 5350-04 |
| 5 | RU 5350-05 |
| 6 | RU 5350-06 |

2,8 mm
Fig. 0000

3,6 mm
Fig. 000

4,4 mm
Fig. 00

5,2 mm
Fig. 0

6,8 mm
Fig. 1

8,5 mm
Fig. 2

10 mm
Fig. 3

11,5 mm
Fig. 4

14,5 mm
Fig. 5

15,5 mm
Fig. 6

- | | |
|------|-------------------|
| Fig. | Spratt |
| 000 | RU 5353-30 |
| 00 | RU 5353-20 |
| 0 | RU 5353-10 |
| 1 | RU 5353-01 |
| 2 | RU 5353-02 |
| 3 | RU 5353-03 |
| 4 | RU 5353-04 |
| 5 | RU 5353-05 |
| 6 | RU 5353-06 |

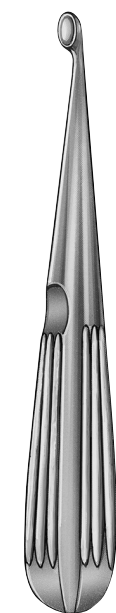

Spratt
16 cm / 6¼"

3,0 mm
Fig. 000

4,0 mm
Fig. 00

4,5 mm
Fig. 0

5,0 mm
Fig. 1

6,0 mm
Fig. 2

7,0 mm
Fig. 3

8,5 mm
Fig. 4

9,5 mm
Fig. 5

11,5 mm
Fig. 6

3,0 mm
RU 7993-10

2,7 mm
RU 7993-20

2,4 mm
RU 7993-30

2,0 mm
RU 7993-40

1,7 mm
RU 7993-50



Lempert
21,5 cm / 8½"

Scharfe Löffel
Bone currettes



Uffendorfer
 17 cm / 6³/₄"
RU 5357-01



Uffendorfer
 17 cm / 6³/₄"
RU 5357-02



Martini
 13,5 cm / 5"



RU 5366-00



RU 5366-01



RU 5366-12

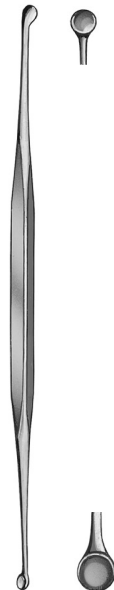

Jansen
 16 cm / 6¹/₄"
RU 5367-00/16

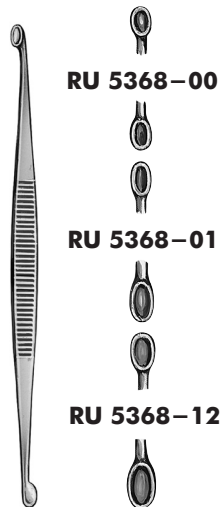

Williger
 13,5 cm / 5"

RU 5368-00

RU 5368-01

RU 5368-12

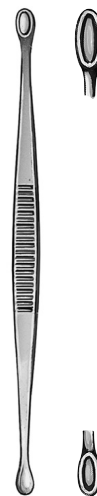

Jacobson
 13 cm / 5"
RU 5369-13

Raspatorien
Periosteal raspatories

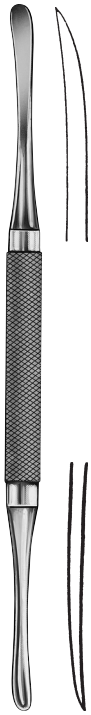

Molt
 19 cm / 7½"
RU 5379-19



Farabeuf
 15 cm / 6"
RU 5380-15

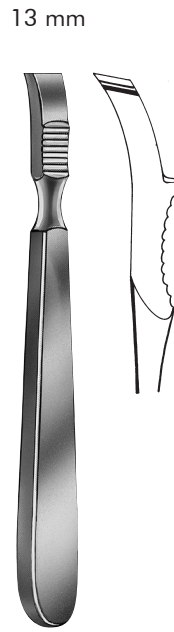

Farabeuf
 15 cm / 6"
RU 5381-15

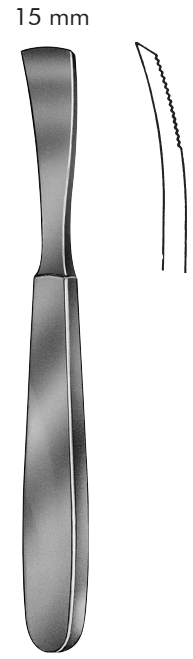

Jansen
 16,5 cm / 6½"
RU 5388-16

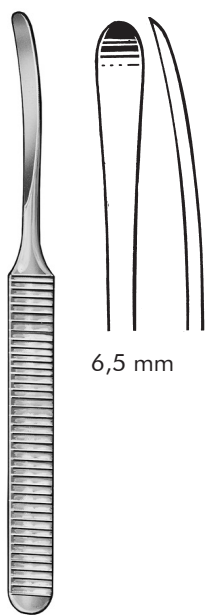

Williger
 16 cm / 6¼"
 4,5 mm **RU 5392-05**
 8,0 mm **RU 5392-08**
 6,5 mm **RU 5392-16**

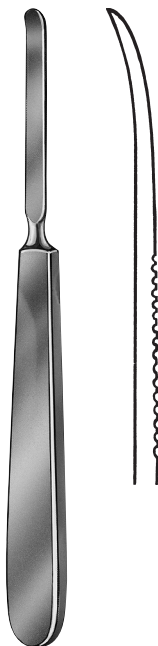

17 cm / 6¾"
 6 mm **RU 5394-06** 8 mm **RU 5394-08**



Joseph
 16 cm / 6¼"
RU 8206-16

4 mm

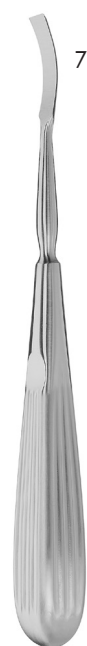

Lempert
 18,0 cm / 7" **RU 7992-18**

7 mm

Raspatorien, Elevatorien
Periosteum raspatories, elevators



19 cm / 7½"
RU 5410-01



18,5 cm / 7¼"
RU 5410-02



18,5 cm / 7¼"
RU 5410-03



18,5 cm / 7¼"
RU 5410-04



Langenbeck
 20 cm / 8"
RU 5420-20

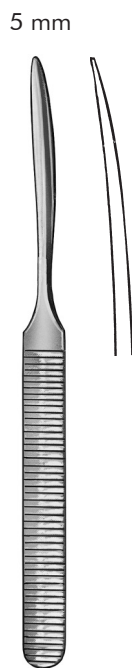

Williger
 16 cm / 6¼"
RU 5426-16

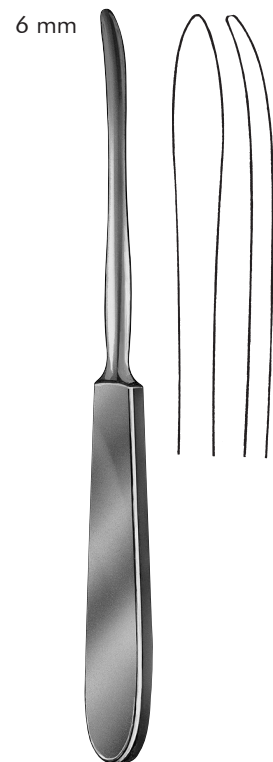

Quervain
 20 cm / 8"
RU 5427-20

Elevatoren, Hohlmeisselzangen
Elevators, bone rongeur forceps



4,5 mm



König
 15 cm / 6"
 RU 5431-01



MDonald
 19 cm / 7½"
 RU 5434-19

6 mm

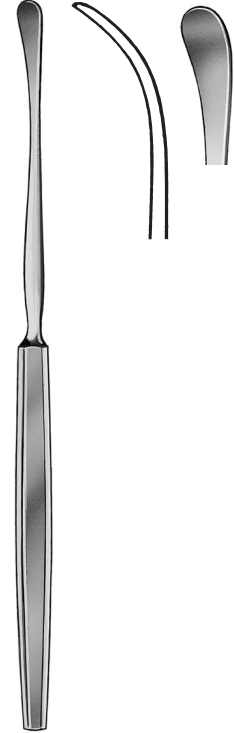

Sewall
 20 cm / 8"
 RU 8335-20

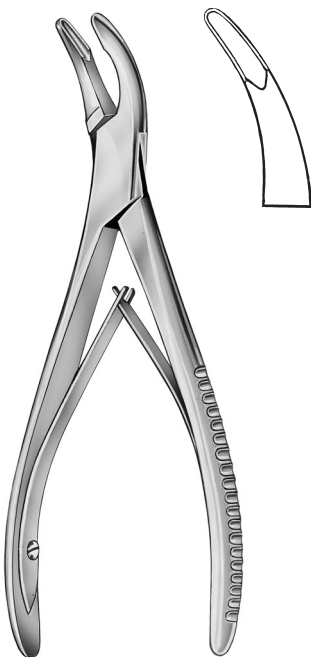

Bane-Hartmann
 17,5 cm / 7"
 RU 5559-17

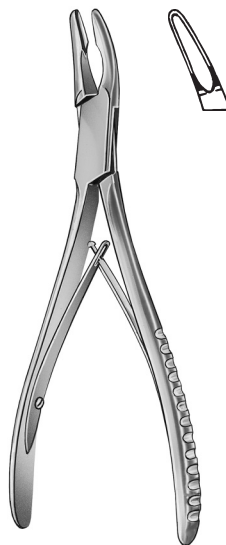

Friedmann
 14 cm / 5½"
 RU 5560-14



Cleveland
 14 cm / 5½"
 RU 5562-14

Hohlmeisselzangen
Bone rongeur forceps



Mead
 16,5 cm / 6½"



RU 5566-16



RU 5568-16

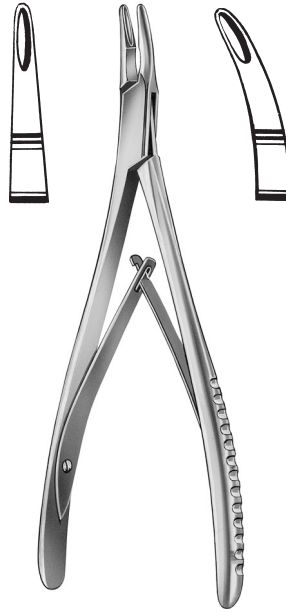

Lempert
 gerade
 straight **RU 5570-16**
 gebogen
 curved **RU 5571-16**
RU 5570-19 **RU 5571-19**

16 cm / 6¼"
 19 cm / 7½"



Beyer
 18 cm / 7"
RU 5572-18



Jansen
 17,5 cm / 7"



RU 5573-17



RU 5574-17



Blumenthal
 15,5 cm / 6"



RU 5575-01



RU 5575-02



RU 5575-03

Hohlmeisselzangen
Bone rongeur forceps

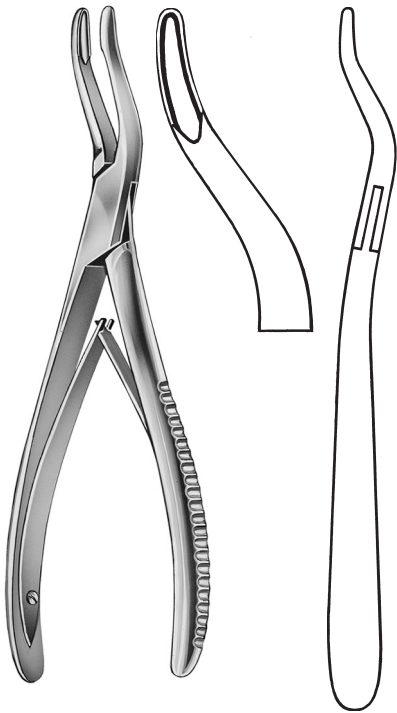

Jansen
 18 cm / 7"
RU 5576-19

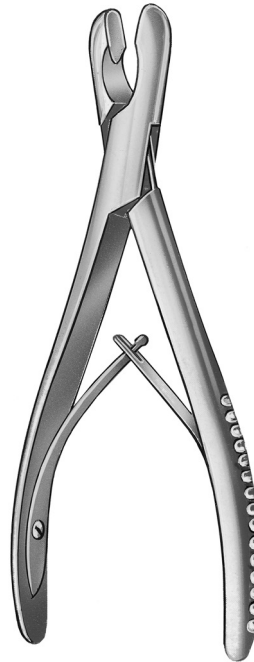

gerade
 straight

RU 5580-17



gebogen
 curved

RU 5581-17



RU 5582-15



RU 5583-15



RU 5584-15

Luer
 17 cm / 6¾"

Luer
 15 cm / 6"



Böhler
 15 cm / 6"



gerade /straight

3 mm
 4 mm

RU 5588-03
RU 5588-15



gebogen /curved

RU 5589-13
RU 5589-15



4 mm
Zaufal-Jansen
RU 5590-18

3 mm

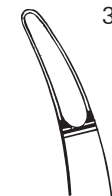

Beyer
RU 5592-18

Zaufal-Jansen
Beyer
 18 cm / 7"

Hohlmeisselzangen, Knochensplitterzangen
Bone rongeur forceps, bone cutting forceps



6 mm



Ruskin
 18 cm / 7"
 gebogen / curved
RU 5594-18

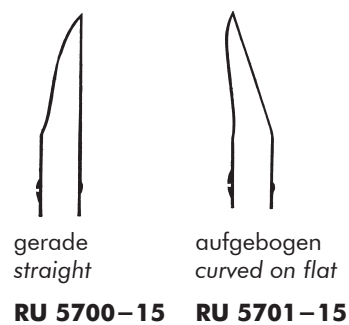

Böhler
 15 cm / 6"



16 cm / 6 1/4"
RU 5759-16

Drahtschneide- und Biegezange
 Wire cutting and bending pliers

Hämmer
Mallets



mit auswechselbaren
Kunststoffbacken
with interchangeable
plastic jaws

Ø 25 mm, 140 g
18 cm / 7"
RU 5799-18

Ersatzbackenpaar
Pair of spare jaws
RU 5799-51

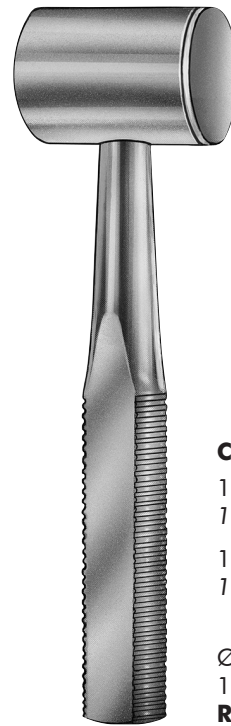

Cottle
1 Seite flach
1 Seite convex
1 side flat
1 side convex

Ø 30 mm, 350 g
19 cm / 7½"
RU 5809-19



Hajek
Ø 27 mm, 140 g
22 cm / 8¾"
RU 5811-23

Mikro-Nadelhalter
Micro needle holders



gerade /straight gebogen /curved



mit Sperre /with ratchet
gerade /straight gebogen /curved

12 cm /4 ³ / ₄ "	RU 5860-12	RU 5861-12	RU 5864-12	RU 5865-12
15 cm /6"	RU 5860-15	RU 5861-15	RU 5864-15	RU 5865-15



Barraquer
12 cm /4³/₄"
RU 5973-12

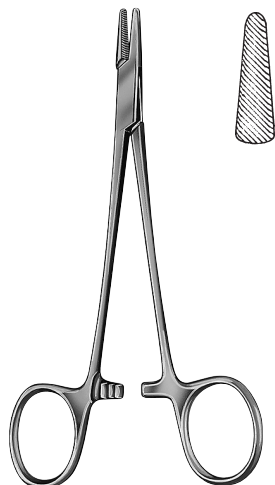

Brown
13 cm / 5" **RU 5928-13**
18 cm / 7" **RU 5928-18**



Mayo-Hegar
schlankes Modell
delicate pattern
16 cm / 6¼" **RU 6003-16**
18 cm / 7" **RU 6003-18**
20 cm / 8" **RU 6003-20**

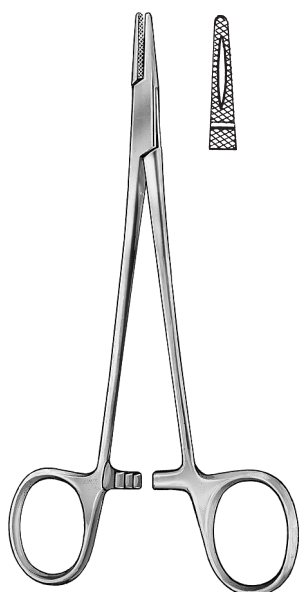

Crile-Wood
15 cm / 6"
RU 6012-15

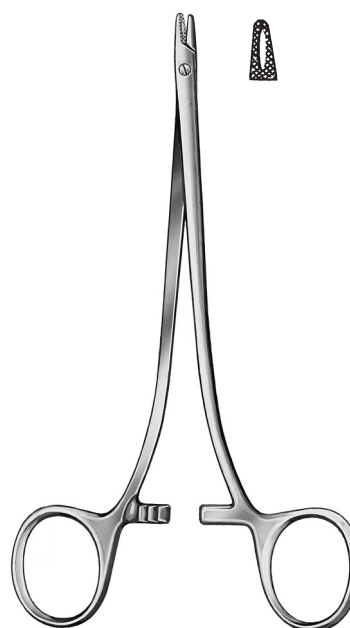

Senning
17 cm / 6¾"
schlank / *slim*
RU 6017-17

Nadelhalter mit Hartmetalleinlagen
Needle holders with tungsten carbide inserts

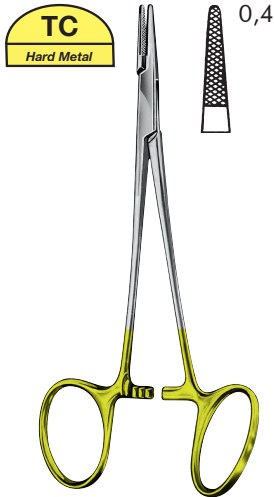

Neivert
 13 cm / 5"
 zwei Ringe abgewinkelt
two rings angled
RU 6045-13

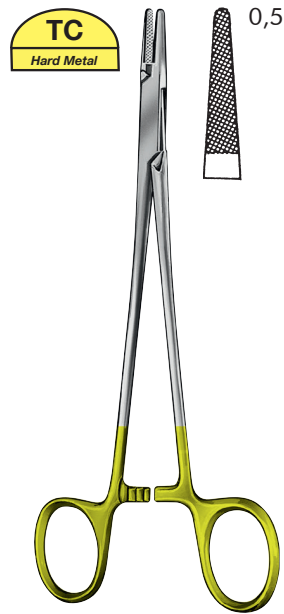

Mayo-Hegar

16 cm / 6 1/4" **RU 6050-16**
 18 cm / 7" **RU 6050-18**
 20 cm / 8" **RU 6050-20**

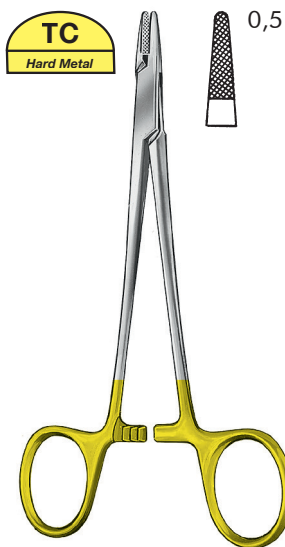

Hegar-Baumgartner
 14 cm / 5 1/2"
RU 6052-14



Mayo-Hegar
 schweres Modell
heavy pattern
 20 cm / 8" **RU 6053-20**

Nadelhalter mit Hartmetalleinlagen
Needle holders with tungsten carbide inserts



De Bakey

18 cm / 7"	RU 6054-18
20 cm / 8"	RU 6054-20
23 cm / 9"	RU 6054-23

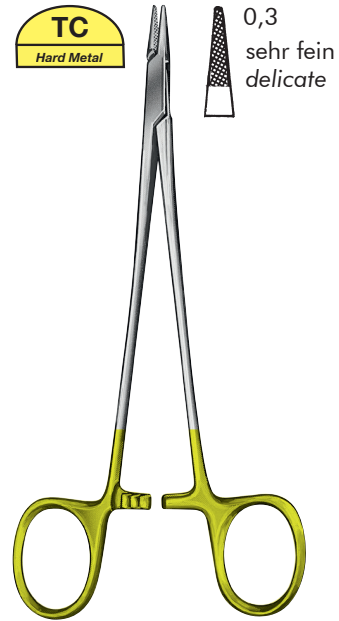

De Bakey

16,5 cm / 6½"	RU 6054-40
21,0 cm / 8¼"	RU 6054-41

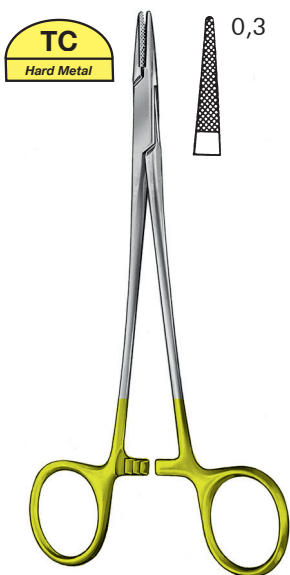

Baby-Crile-Wood

15 cm / 6"	RU 6055-01
------------	-------------------



Crile-Wood

15 cm / 6"	RU 6055-15
------------	-------------------

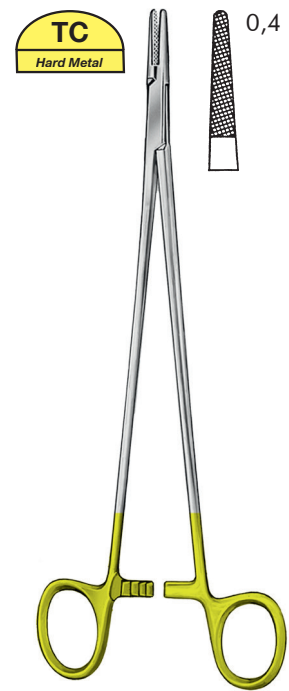

Crile-Wood

18 cm / 7"	RU 6055-18
20 cm / 8"	RU 6055-20

Nadelhalter mit Hartmetalleinlagen
Needle holders with tungsten carbide inserts

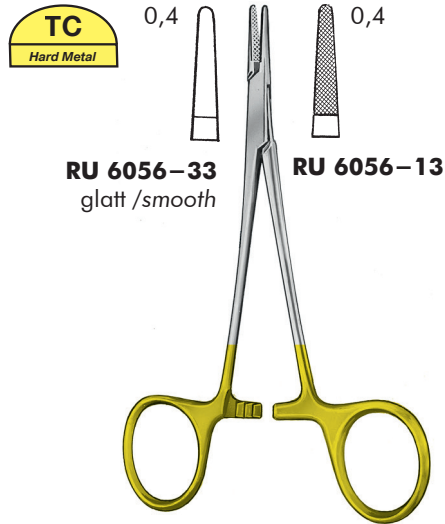

Halsey
 13 cm / 5"

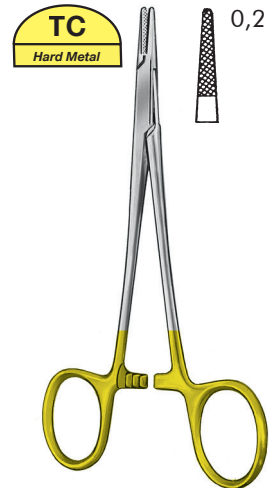

Converse
 12,5 cm / 5"
RU 6057-12

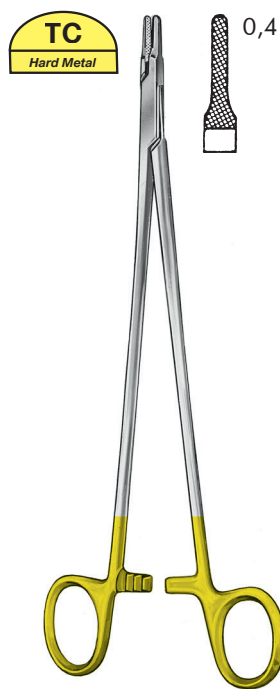

Ryder

13 cm / 5"	RU 6059-13
15 cm / 6"	RU 6059-16
18 cm / 7"	RU 6059-18
20 cm / 8"	RU 6059-20

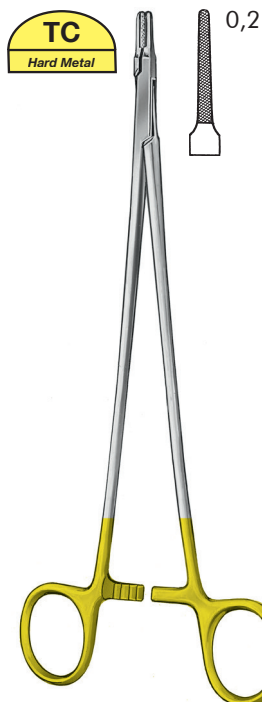

Micro-Ryder

	RU 6059-63
	RU 6059-65
	RU 6059-68
	RU 6059-70

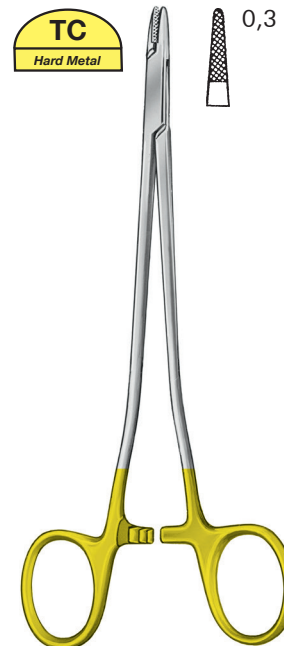

Rudolf
 (Swedish pattern)

15 cm / 6"	RU 6060-01
17 cm / 6¾"	RU 6060-02

Nadelhalter mit Hartmetalleinlagen
Needle holders with tungsten carbide inserts

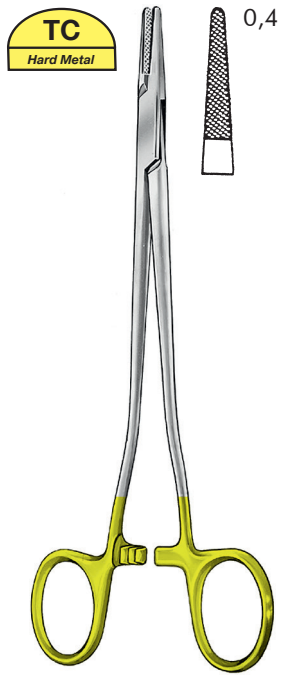

Sarot
18 cm / 7"
RU 6060-18



Mathieu
17 cm / 6"
20 cm / 8"
RU 6066-17
RU 6066-20



Lichtenberg
20 cm / 8"
RU 6068-20

Nadelhalter mit Hartmetalleinlagen
Needle holders with tungsten carbide inserts



Baby-Olsen-Hegar
11,5 cm / 4½"
RU 6079-11



Olsen-Hegar
14 cm / 5½"
RU 6080-14



Olsen-Hegar
17 cm / 6¾"
RU 6080-17

Unterbindungsnadeln
Ligature needles

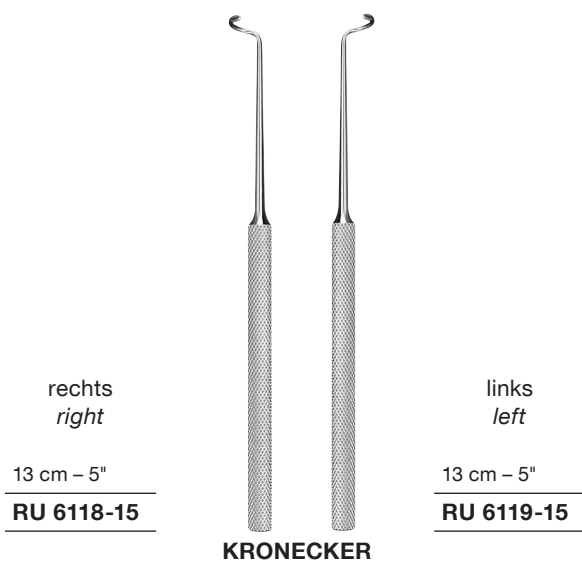
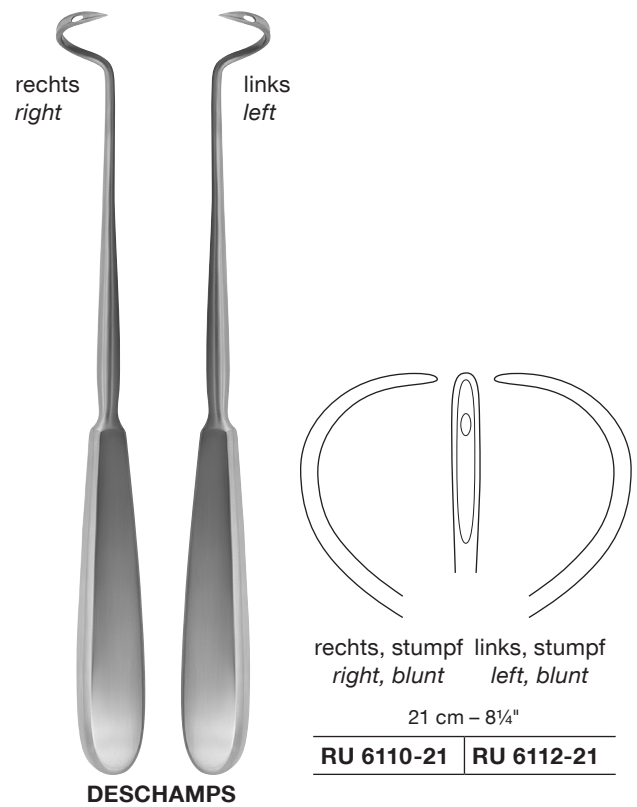
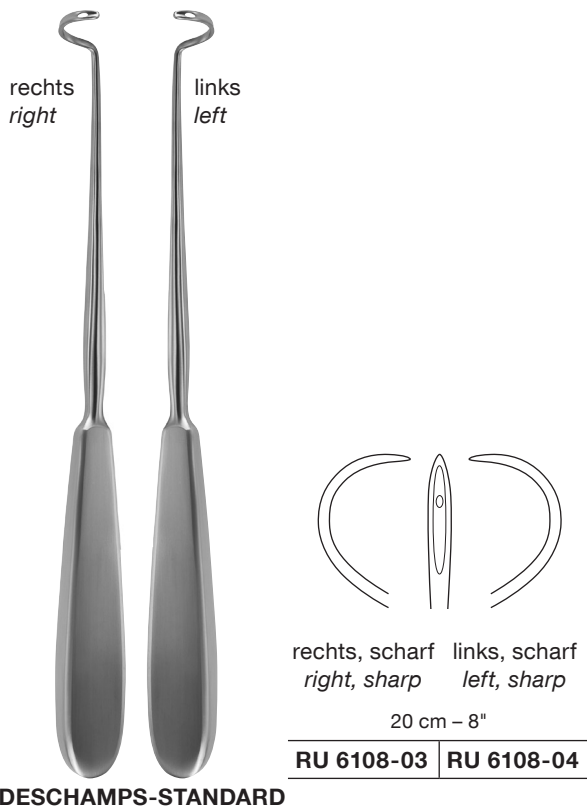

! links = für die linke Hand rechts = für die rechte Hand
left = for left hand right = for right hand



König
19,5 cm / 7³/₄"
RU 6141-19



König
19,5 cm / 7³/₄"
RU 6142-19

Absaugrohre Suction tubes



Ø 5 mm Charr. /Fr. 15
17 cm /6 3/4"
RU 6417-01

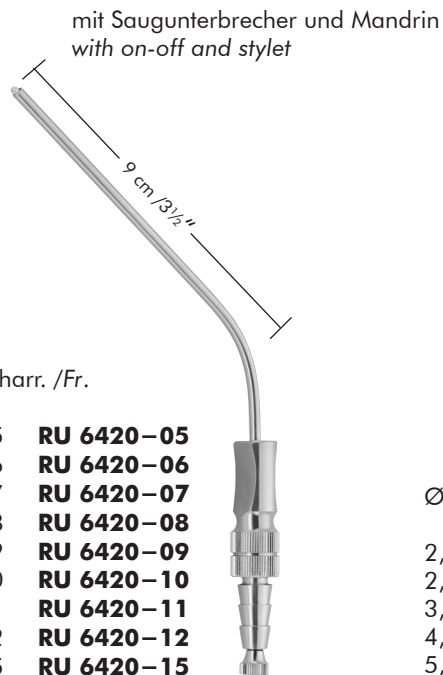

Ø	Charr. /Fr.	
1,5 mm	5	RU 6420-05
2,0 mm	6	RU 6420-06
2,3 mm	7	RU 6420-07
2,5 mm	8	RU 6420-08
3,0 mm	9	RU 6420-09
3,3 mm	10	RU 6420-10
3,5 mm	11	RU 6420-11
4,0 mm	12	RU 6420-12
5,0 mm	15	RU 6420-15

**Frazier
(Fergusson)**



Ø	Charr. /Fr.	
2,0 mm	6	RU 6420-56
2,5 mm	8	RU 6420-58
3,3 mm	10	RU 6420-60
4,0 mm	12	RU 6420-62
5,0 mm	15	RU 6420-65

Frazier

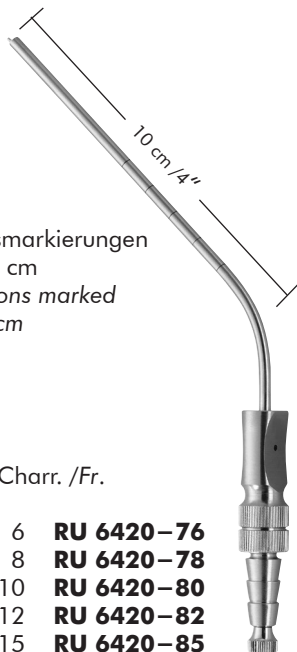

Ø	Charr. /Fr.	
2,0 mm	6	RU 6420-76
2,5 mm	8	RU 6420-78
3,3 mm	10	RU 6420-80
4,0 mm	12	RU 6420-82
5,0 mm	15	RU 6420-85

Frazier

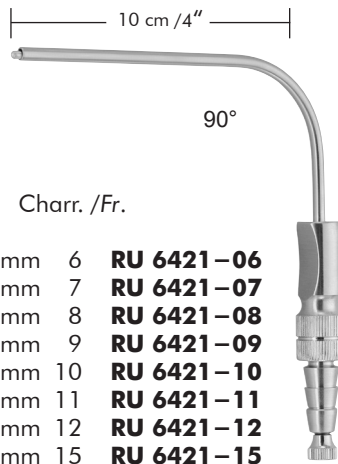

Ø	Charr. /Fr.	
2,0 mm	6	RU 6421-06
2,3 mm	7	RU 6421-07
2,5 mm	8	RU 6421-08
3,0 mm	9	RU 6421-09
3,3 mm	10	RU 6421-10
3,5 mm	11	RU 6421-11
4,0 mm	12	RU 6421-12
5,0 mm	15	RU 6421-15

Fergusson

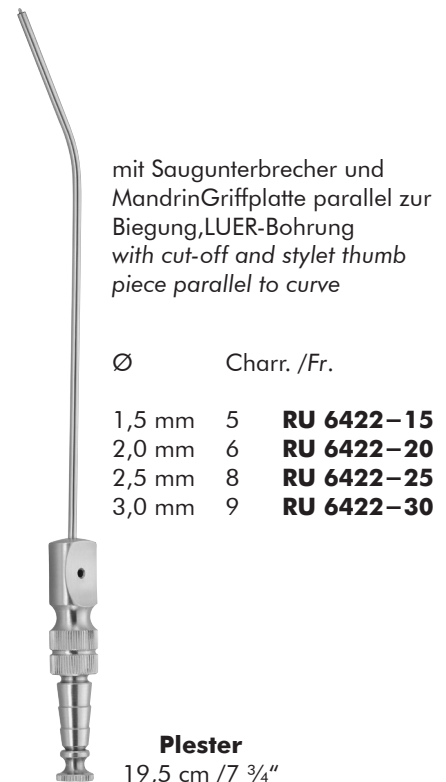

Ø	Charr. /Fr.	
1,5 mm	5	RU 6422-15
2,0 mm	6	RU 6422-20
2,5 mm	8	RU 6422-25
3,0 mm	9	RU 6422-30

Plester
19,5 cm /7 3/4"



**Saugkopf /
Suction tube**



Yankauer
27 cm /10½"
RU 5260-27
Saugkanüle
Suction tube



20 cm /8"
scharf /sharp
RU 6429-30
Saug-Raspatorium
Suction Raspatory



Präparierscheren, Feine Scheren	<i>Dissecting Scissors, Fine Scissors</i>	127
Feine Scheren	<i>Fine Scissors</i>	128
Pinzetten	<i>Dressing and Tissue Forceps</i>	129
Ohrpinzetten	<i>Ear Dressing and Tissue Forceps</i>	130
Wundsperrer, Ohrsonden	<i>Retractors, Ear Probes</i>	131 — 132
Watteträger	<i>Cotton Applicators</i>	133
Nystagmus - Brillen	<i>Nystagmus Spectacles</i>	134
Flach- und Hohlmeißel, Osteotome	<i>Chisels, Gouges and Osteotomes</i>	135
Stößel und Meißel	<i>Pestles and Chisels</i>	136
Scharfe Löffel	<i>Bone Curettes</i>	137 — 138
Raspatorien	<i>Raspatories</i>	139
Raspatorien, Elevatorien	<i>Raspatories, Elevatories</i>	140
Hohlmeißelzangen	<i>Bone Rongeur Forceps</i>	141 — 142
Knochensplitterzangen	<i>Bone Cutting Forceps</i>	143
Hämmer	<i>Mallets</i>	144
Stanzen	<i>Punches</i>	145
Ohrspekula	<i>Ear Specula</i>	146 — 148
Stimmgabeln	<i>Tuning Forks</i>	149 — 150
Saugrohre, Saugadapter	<i>Suction Tubes, Suction Adapters</i>	151
Saugrohre, Saug - und Spülkanülen	<i>Suction Tubes, Suction and Irrigation Cannulae</i>	152 — 153
Polypenschnürer, Polypenschlingen	<i>Polypus Snares, Wire Loops</i>	154
Ohrzängchen, Fremdkörperheber	<i>Ear Forceps, Foreign Body Levers</i>	155
Ohrzängchen	<i>Ear Forceps</i>	156 — 157
Mikro - Ohrzängchen	<i>Micro Ear Forceps</i>	158, 161
Löffelzangen, Drahtbiegezängchen	<i>Cup Shaped Forceps, Wire Bending Forceps</i>	159, 163
Mikro - Ohrscheren	<i>Micro Ear Scissors</i>	160
Mikro - Löffelzangen, -Scheren	<i>Cup Shaped Micro Forceps, Micro Scissors</i>	162



Mikrozangen und -Scheren	<i>Micro Forceps and Scissors</i>	164
Mikro -scheren, -Stanzen, -Zängchen	<i>Micro Scissors, Nippers, Forceps</i>	165
Mikro -Löffelzängchen	<i>Micro Cup Shaped forceps</i>	166
Mikro -Zängchen	<i>Micro Forceps</i>	167
Mikroscheren	<i>Micro Scissors</i>	168
Mikrochirurgie-Messer	<i>Micro Surgery Knives</i>	169 — 172
Mikrochirurgie-Nadeln und -Häkchen	<i>Micro Surgery Needles and Hooks</i>	173 — 175
Mikrochirurgie – Diverses Instrumentarium	<i>Micro Surgery – Various Instruments</i>	176 — 179
Küretten, Löffel, Schlingen	<i>Curettes, Spoons, Loops</i>	180
Häkchen	<i>Hooks</i>	181
Messer, Myringotome, Parazentesenadeln, Nierenschale	<i>Knives, Myringotomes, Paracentesis Needles, Kidney Bowl</i>	182 — 183

Präparierscheren, Feine scheren
Dissecting scissors, fine scissors

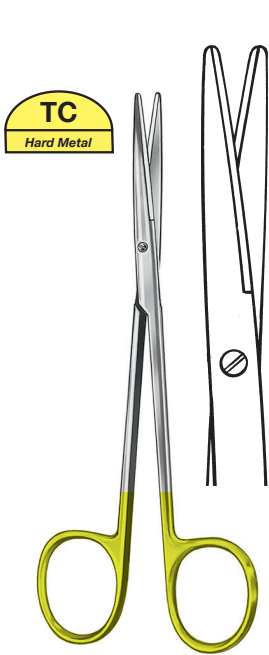

Metzenbaum
 14,5 cm/5½"
 gerade/straight
RU 1304-14

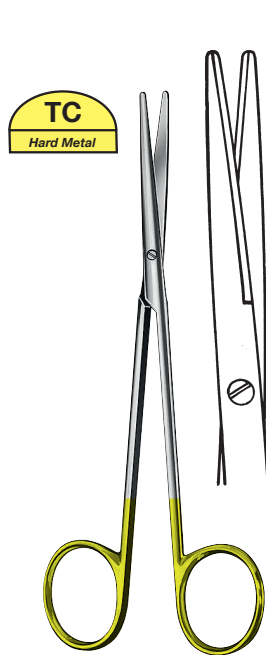

Metzenbaum-Fino
 14,5 cm/5½"
 gerade/straight
RU 1306-14

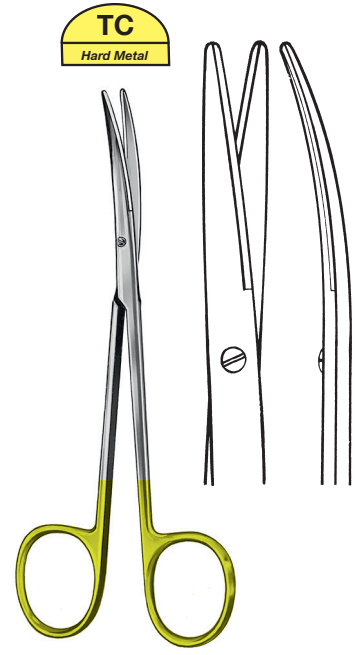

Metzenbaum
 14,5 cm/5½"
 gebogen/curved
RU 1314-14



Metzenbaum-Fino
 14,5 cm/5½"
 gebogen/curved
RU 1316-14



Joseph
 14 cm/5¼"
 gerade/straight
RU 1670-14



Joseph
 14 cm/5¼"
 gebogen/curved
RU 1671-14

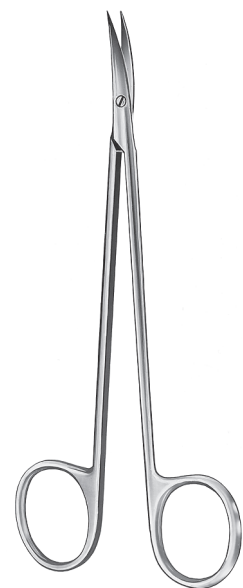

Joseph
 15 cm/6"
RU 1792-15



Fino
 gerade/straight

9,5 cm/3³/₄" **RU 2422-09**

10,5 cm/4¹/₄" **RU 2422-10**

11,5 cm/4¹/₂" **RU 2422-11**



Fino
 gebogen/curved

RU 2423-09

RU 2423-10

RU 2423-11



11,5 cm/4¹/₂"
 gerade/straight
RU 2462-11



11,5 cm/4¹/₂"
 gebogen/curved
RU 2463-11

Pinzetten
Dressing and tissue forceps



12 cm/5"
 15 cm/6"
Semken
RU 4040-12
RU 4040-15



Semken
RU 4140-12
RU 4140-15



Lazar
 15,5 cm/6"



0,5 mm

RU 4075-05



0,8 mm

RU 4075-08



Derlacki
 12 cm/4¾"
RU 4143-12



No. 5
 11,5 cm/4½"
RU 4240-05

Ohrpinzetten
Ear dressing and tissue forceps

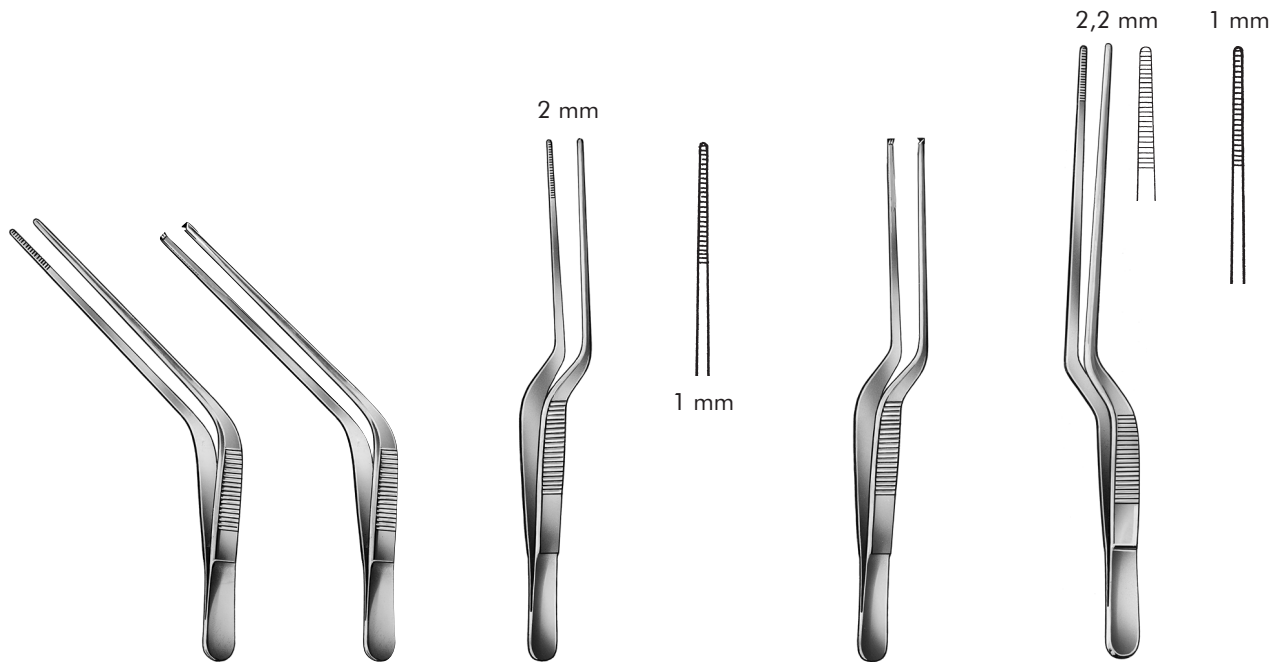

	Troeltsch (Wilde)	Troeltsch	Lucae		Lucae	Jansen (Gruenwald)	
11 cm/4½"	RU 7860-11	—	—	—	—	—	—
12 cm/4¾"	RU 7860-12	RU 7861-12	—	—	—	—	—
14 cm/5½"	—	—	RU 7862-14	RU 7862-24	RU 7863-14	—	—
15 cm/6"	RU 7860-15	—	—	—	—	—	—
16 cm/6¼"	—	—	—	—	—	RU 7864-16	RU 7864-26
18 cm/7"	RU 7860-18	—	—	—	—	RU 7864-18	RU 7864-28
20 cm/8"	—	—	—	—	—	RU 7864-20	RU 7864-30

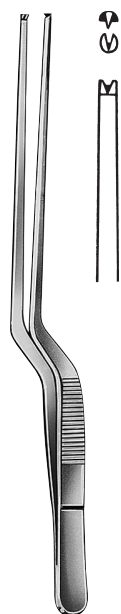

16 cm/6¼"
RU 7865-16
 18 cm/7"
RU 7865-20

Jansen

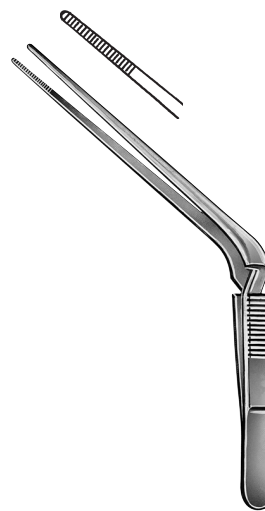

12 cm/4¾"
 selbstschließend
 cross action
RU 7866-12

Troeltsch

Wundsperrer
Retractors

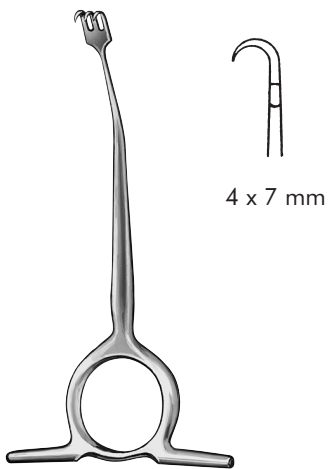

Williger
12 cm/4³/₄"
RU 4472-25



Jansen
10,5 cm/4¹/₄"
scharf/sharp stumpf/blunt
RU 4680-10 RU 4681-10

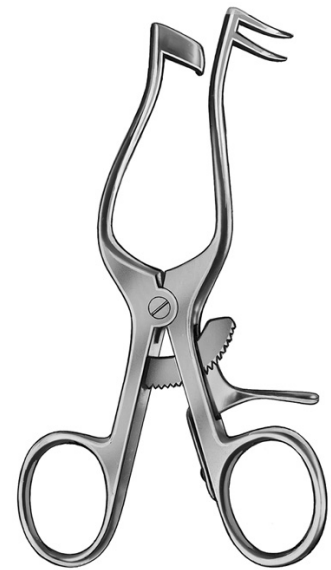

Plester
11 cm/4¹/₂"
RU 4690-01

volles Blatt mit
atraumatischer Zahnung
*Blade with
atraumatic teeth*



Plester-Helms
11 cm/4¹/₂"
RU 4689-01



Plester
11 cm/4¹/₂"
RU 4690-02

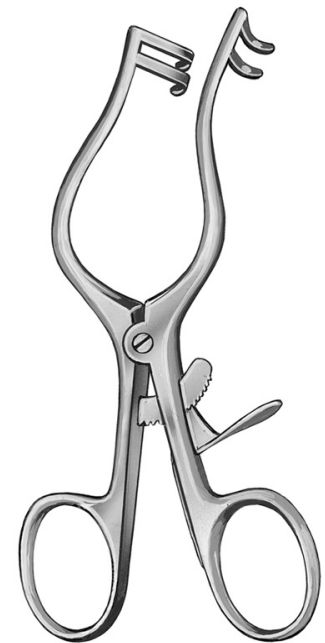

Plester
13 cm/5"
scharf/sharp stumpf/blunt
RU 4691-01 RU 4691-02

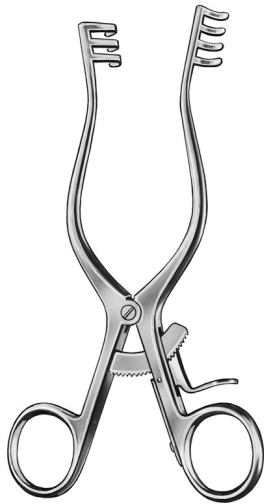

Weitlaner

scharf/sharp stumpf/blunt

Weitlaner-Wullstein

scharf/sharp stumpf/blunt

13,0 cm/5"	RU 4700-13	RU 4701-13	RU 4710-13	RU 4711-13
16,5 cm/6½"	RU 4700-16	RU 4701-16	RU 4710-16	RU 4711-16

verstellbar
adjustable



Fisch

stumpf/blunt

17 cm/6¾"

RU 4694-11



Stacke

10,5 cm/4¼"

Ø 1,0 mm

RU 4916-10



Seiffert

14 cm / 5½"

Ø 0,5 mm

RU 4914-14

Myrtenblattsonde
Myrtle blade probe



Piccolo
 11 cm/4½"
 Ø 0,7 mm
 rund/round
RU 4928-01



	Universal		
	Ø 1,2 mm	Ø 1,5 mm	Ø 1,7 mm
12,5 cm/5"	RU 4930-12	—	—
16,0 cm/6¼"	RU 4930-16	—	—
18,0 cm/7"	—	RU 4931-18	RU 4932-18



Jobson-Horne
 18 cm/7"
RU 4933-02



Farell
(Farell-Lathbury)

rund
 round

dreikant
 triangular

14 cm/5½"	Ø 0,9 mm	RU 4935-14	—
16 cm/6¼"	Ø 1,1 mm	RU 4935-16	RU 4936-16

Nystagmus-Brillen

Nystagmus spectacles



Nystagmus-Brillen nach Prof. Frenzel

Nystagmus Spectacles by Prof. Frenzel

- | | | |
|-------------------|--|---|
| RU 5140-00 | - klappbare Gläser
- festes Anschlußkabel
- Kopfband | - <i>hinged lenses</i>
- <i>fixed connection wire</i>
- <i>head strap</i> |
| RU 5140-22 | - feste Gläser
- festes regelbarer Batteriegriff, oben | - <i>fixed lenses</i>
- <i>adjustable battery holder on top</i> |



RU 5140-22

RU 5140-70

Batteriegehäuse

gewährleistet die Stromversorgung der Nystagmus-Brille über 3 Batterien Babyzellen (C LR14/AM-2) 1,5 V und ermöglicht so (Stromnetz-) unabhängiges Arbeiten.

Batterien nicht im Lieferumfang

Battery Housing

In order to allow a usage independent of the power supply, alternatively the Nystagmus Spectacle can be supplied with power through the battery housing. It can be operated with three 1.5 Volt batteries, size C LR14/AM-2 (baby cells).

Batteries are not included



RU 5140-50

Ersatzlampe

für alle Nystagmus-Brillen,
4 V, 0,23 Ampere, 1 Watt

Replacement lamp

for all Nystagmus Spectacles,
4 Volt, 0.23 Ampere, 1 Watt

Flach- und Hohlmeißel, Osteotome
Chisels, gouges and osteotomes

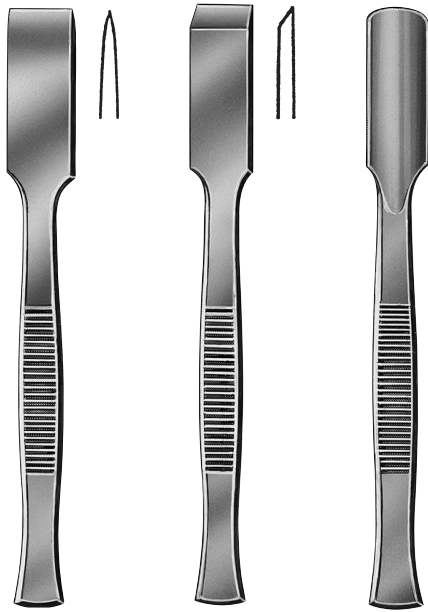

Breite/
width

13,5 cm/5¼"

4 mm	RU 5300-04	RU 5302-04	RU 5304-04
6 mm	RU 5300-06	RU 5302-06	RU 5304-06
8 mm	RU 5300-08	RU 5302-08	RU 5304-08
10 mm	RU 5300-10	RU 5302-10	RU 5304-10
12 mm	RU 5300-12	RU 5302-12	RU 5304-12
	Osteotome	Flachmeißel	Hohlmeißel
	Osteotomes	Chisels	Gouges



Parsch
 13,5 cm/5¼" mm
RU 5308-02 2
RU 5308-03 3
RU 5308-05 5
RU 5308-07 7
RU 5308-08 8
 Flachmeißel
 Chisels

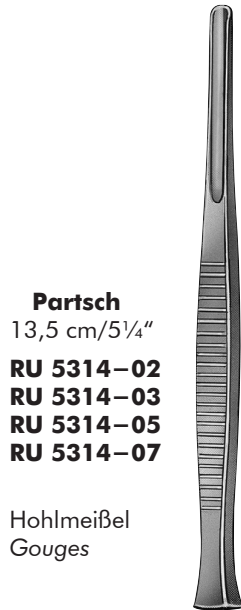

Parsch
 13,5 cm/5¼" mm
RU 5314-02
RU 5314-03
RU 5314-05
RU 5314-07
 Hohlmeißel
 Gouges



Thies
 16 cm/6¼"
 Flachmeißel
 Chisels



3 mm
RU 5309-03



4 mm
RU 5309-04



Thies
 16 cm/6¼"
 Hohlmeißel
 Gouges



3 mm
RU 5315-03



4 mm
RU 5315-04

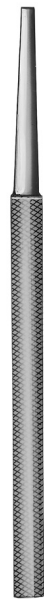

16 cm/6¼"

- Ø 3 mm
RU 5317-03
- Ø 5 mm
RU 5317-05
- Ø 7 mm
RU 5317-07
- Ø 9 mm
RU 5317-09



Passow
 12 cm/4¾"

- 2,5 mm
RU 5318-02
- 3,5 mm
RU 5318-03



Mini-Lexer

18 cm/7"

- Osteotome
Osteotomes
- RU 5334-04** 4 mm
 - RU 5334-06** 6 mm
 - RU 5334-08** 8 mm
 - RU 5334-10** 10 mm
 - RU 5334-12** 12 mm

- Hohlmeißel
Gouges
- RU 5335-04**
 - RU 5335-06**
 - RU 5335-08**
 - RU 5335-10**
 - RU 5335-12**



Scharfe Löffel
Bone currettes



Volkmann
 17 cm/6¾"

- Fig.
 0000 **RU 5350-40**
 000 **RU 5350-30**
 00 **RU 5350-20**
 0 **RU 5350-10**
 1 **RU 5350-01**
 2 **RU 5350-02**
 3 **RU 5350-03**
 4 **RU 5350-04**
 5 **RU 5350-05**
 6 **RU 5350-06**

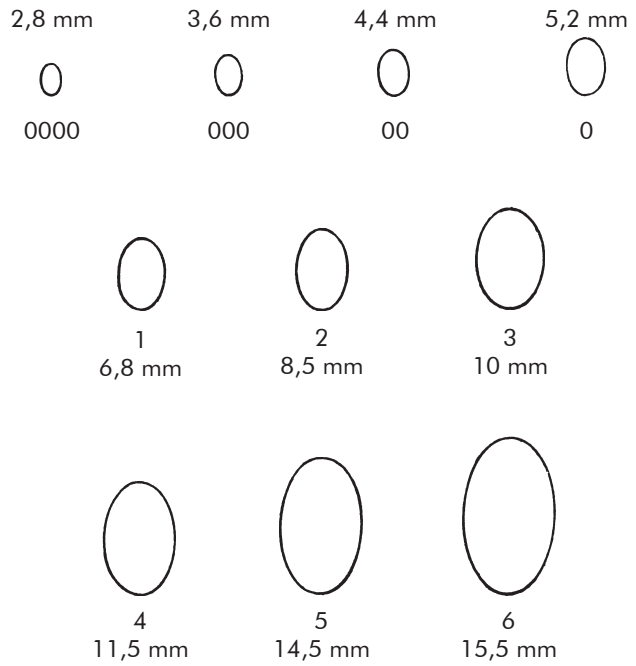

Lempert
 17,5 cm/7"

- RU 7993-10**
- RU 7993-20**
- RU 7993-30**
- RU 7993-40**
- RU 7993-50**



Williger
 17,5 cm/7"

- RU 5356-20**
- RU 5356-01**
- RU 5356-02**



Martini
 13,5cm/5"

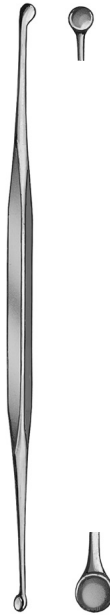

Jansen
 16 cm/6¼"
RU 5367-00/16



Williger
 13,5 cm/5"



Jacobson
 13 cm/5"
RU 5369-13

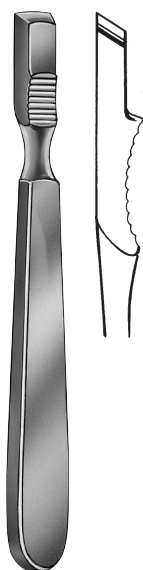

Farabeuf
15 cm/6"
RU 5380-15

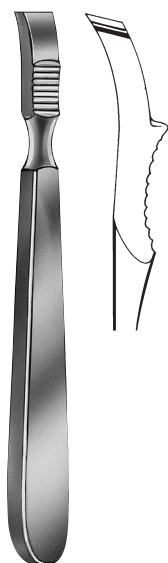

Farabeuf
15 cm/6"
RU 5381-15

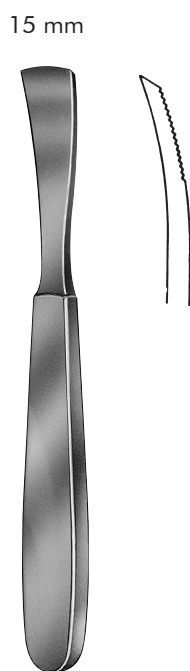

Jansen
16,5 cm/6½"
RU 5388-16

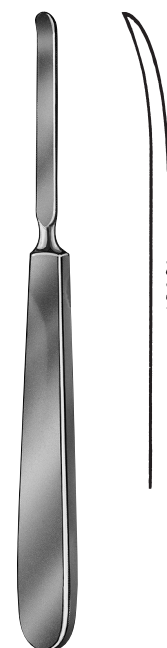

17 cm/6¾"
6 mm 8 mm
RU 5394-06 RU 5394-08



19 cm/7½"
RU 5410-01



18,5 cm/7¼"
RU 5410-02



18,5 cm/7¼"
RU 5410-03



18,5 cm/7¼"
RU 5410-04



Eicken
 Ø 6 mm
 19,5 cm / 7¾"
RU 5413-06



Jansen
 Ø 9 mm
 19,5 cm / 7¾"
RU 5414-09



Jansen
 Ø 14 mm
 19,5 cm / 7¾"
RU 5414-14

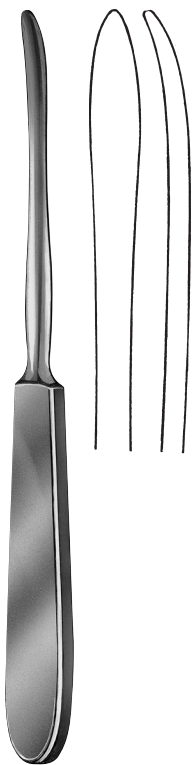

Quervain
 20 cm / 8"
RU 5427-20



König
 Ø 4,5 mm
 15 cm / 6"
RU 5431-01

Hohlmeisselzangen
Bone rongeur forceps

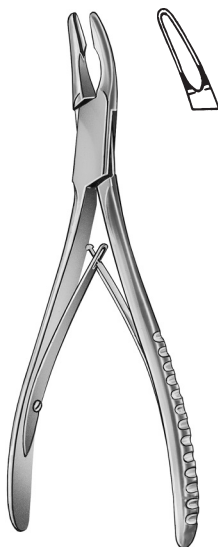

Friedmann
 14 cm/5½"
RU 5560-14

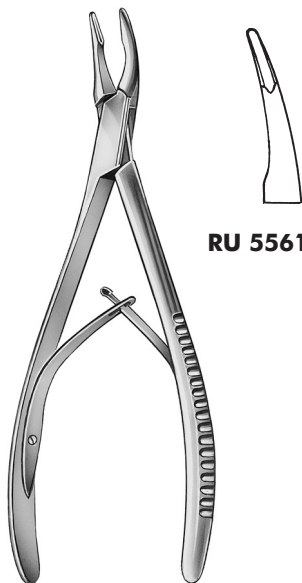

RU 5561-15

Friedmann-Delikat
 15 cm/6"



gerade
 straight

gebogen
 curved

RU 5570-16 16 cm/6¼"
RU 5570-19 19 cm/7½"

RU 5571-16
RU 5571-19



Beyer
 18 cm/7"
RU 5572-18

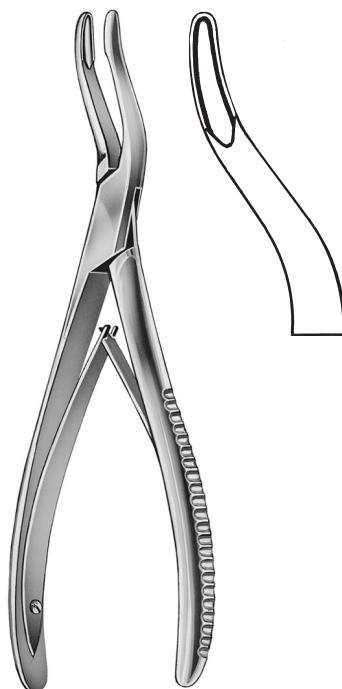

Jansen
 18 cm/7"
RU 5576-19



Hohlmeisselzangen
Bone rongeur forceps

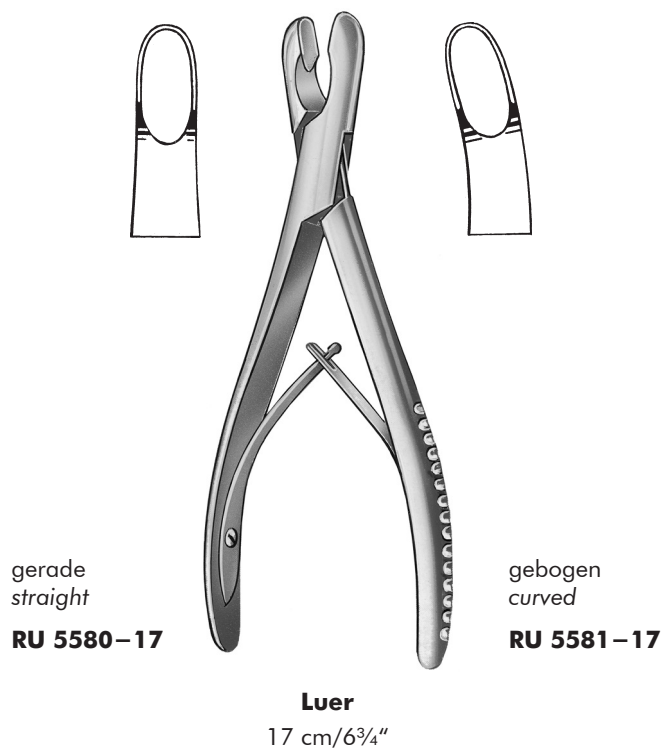

Böhler
 15 cm/6"

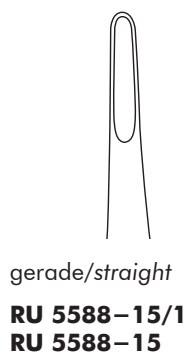

3 mm
 4 mm



Beyer
Zaufal-Jansen
 18 cm/7"



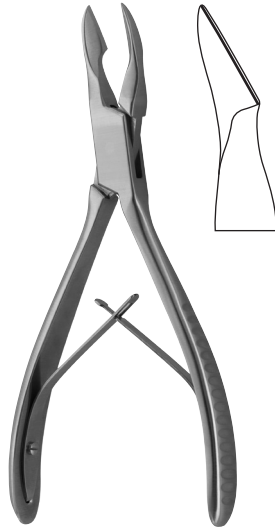

Cleveland

15 cm/6"

RU 5648-15



gerade
straight

RU 5700-15



aufgebogen
curved on flat

RU 5701-15

Böhler

15 cm/6"

Hämmer
Mallets



Ersatzbackenpaar
Pair of spare jaws
RU 5799-51

mit auswechselbaren
Kunststoffbacken
with interchangeable
plastic jaws

18 cm/7"
Ø 25 mm, 140 g
RU 5799-18

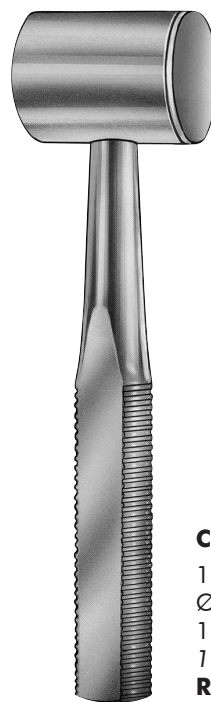

Cottle

19 cm/7½"
Ø 30 mm, 250 g
1 Seite flach, 1 Seite konvex
1 side flat, 1 side convex
RU 5809-19



Hajek

22 cm/8¾"
Ø 27 mm, 140 g
RU 5811-23



Fig. 1
19 mm Ø, 80 g
RU 5813-01

Fig. 2
25 mm Ø, 250 g
RU 5813-02

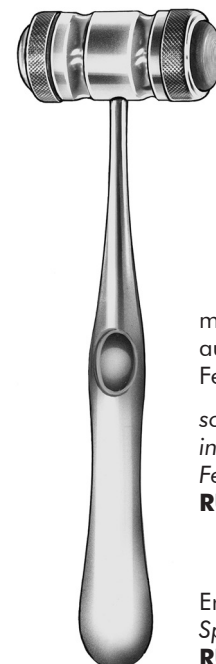

massiv, mit
auswechselbaren
Ferrozellbacken

solid, with
interchangeable
Ferrozell jaws
RU 5816-17

Ersatzbackenpaar
Spare jaws, pair
RU 5816-20

Mead

17 cm/6¾"
Ø 26 mm, 320 g

Stanzen
Bunches



90° aufwärts schneidend
90° upwards cutting

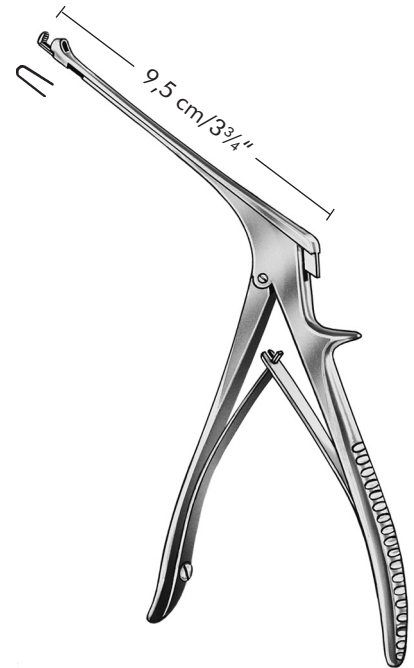

Beyer





Bißbreite 2 mm **Citelli**
Width of bite 3 mm **RU 7895-20**
RU 7895-30

Bißbreite 1 mm **Beyer**
Width of bite **RU 7896-15**



90° aufwärts schneidend
90° upwards cutting

Kerrison
20 cm/8"

-  3,0 mm **RU 8134-03**
-  4,0 mm **RU 8134-04**
-  5,0 mm **RU 8134-05**
-  6,0 mm **RU 8134-06**

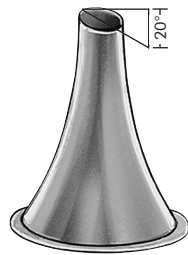

Farrior

oval,
20° abgeschrägt
oval,
20° slanted

rostfreier Stahl
stainless steel

		I Ø	A Ø	
	Fig. 1	3,0 x 4,0 mm	3,8 x 4,8 mm	RU 7801-01NR
	Fig. 2	4,0 x 5,0 mm	4,8 x 5,8 mm	RU 7801-02NR
	Fig. 3	4,5 x 5,5 mm	5,3 x 6,3 mm	RU 7801-03NR
	Fig. 4	5,0 x 6,0 mm	5,8 x 6,8 mm	RU 7801-04NR
	Fig. 5	5,5 x 6,5 mm	6,3 x 7,3 mm	RU 7801-05NR
	Fig. 6	6,0 x 7,0 mm	6,8 x 7,8 mm	RU 7801-06NR
	Fig. 7	6,5 x 7,5 mm	7,3 x 8,3 mm	RU 7801-07NR
	Fig. 8	7,0 x 8,0 mm	7,8 x 8,8 mm	RU 7801-08NR
	Fig. 9	7,5 x 8,5 mm	8,3 x 9,3 mm	RU 7801-09NR
Satz/Set, Fig. 1-9				RU 7801-90NR



Politzer

für Kinder
for children

	I Ø	A Ø	rostfreier Stahl stainless steel
Fig. 1	2,0 mm	3,0 mm	RU 7802-02NR
Fig. 2	3,0 mm	4,0 mm	RU 7802-03NR
Fig. 3	4,0 mm	5,0 mm	RU 7802-04NR
Satz/Set, Fig. 1-3			RU 7802-30NR

I Ø = Innendurchmesser
Inner diameter

A Ø = Außendurchmesser
Outer diameter

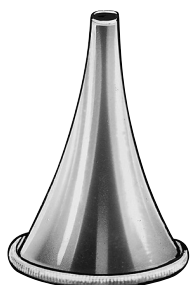

	I Ø	A Ø	rostfreier Stahl stainless steel
Fig. 1	2,0 mm	3,0 mm	RU 7804-02NR

Hartmann
für Säuglinge
for babies



Hartmann
für Erwachsene
for adults

	I Ø	A Ø	rostfreier Stahl stainless steel
Fig. 3	4,0 mm	5,0 mm	RU 7804-04NR
Fig. 4	5,5 mm	6,5 mm	RU 7804-05NR
Fig. 5	6,5 mm	7,5 mm	RU 7804-06NR
Fig. 6	8,0 mm	9,0 mm	RU 7804-07NR
Satz/Set, Fig. 4-6			RU 7804-30NR
Satz/Set, Fig. 3-6			RU 7804-40NR



Hartmann
für Kinder
for children

	I Ø	A Ø	rostfreier Stahl stainless steel
Fig. 2	3,0 mm	4,0 mm	RU 7804-03NR
Fig. 3	4,0 mm	5,0 mm	RU 7804-04NR
Fig. 4	5,5 mm	6,5 mm	RU 7804-05NR
Satz/Set, Fig. 2-4			RU 7804-20NR

I Ø = Innendurchmesser
Inner diameter

A Ø = Außendurchmesser
Outer diameter

Ohrspekula, Metallständer
Ear specula, metal stand



Hartmann

	I Ø	A Ø	
Fig. 1	3,0 mm	4,0 mm	RU 7809-03
Fig. 2	4,0 mm	5,0 mm	RU 7809-04
Fig. 3	5,0 mm	6,0 mm	RU 7809-05
Fig. 4	7,0 mm	8,0 mm	RU 7809-07
Satz/Set, Fig. 1-4			RU 7809-40
schwarz verchromt black chromium-plated			

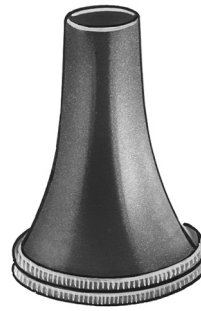

Hartmann

	I Ø	A Ø	
Fig. 5	2,5 mm	8,5 mm	RU 7809-09
Fig. 6	9,0 mm	10,0 mm	RU 7809-11
Satz/Set, Fig. 5-6			RU 7809-20
schwarz verchromt black chromium-plated			

I Ø = Innendurchmesser
Inner diameter

A Ø = Außendurchmesser
Outer diameter

Metallständer für 12 Ohrspekula
Metal stand for 12 ear specula

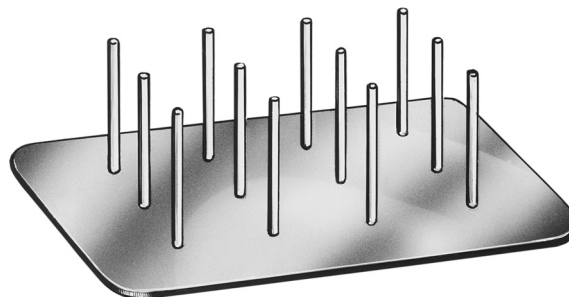

RU 7810-12

Stimmgabeln
Tuning forks



a¹ 440

RU 7818-00



Hartmann



**Lucae
Hartmann**



French

C	128	RU 7820-00	RU 7822-00	RU 7825-02
C¹	256	RU 7820-01	RU 7822-01	RU 7825-03
C²	512	RU 7820-02	RU 7822-02	—
C³	1024	RU 7820-03	RU 7822-03	—
C⁴	2048	RU 7820-04	—	—
C⁵	4096	RU 7820-05	—	—



verschiebbar bis h
variable up to h (Engl. b)

**Lucae
C 128**

RU 7826-00

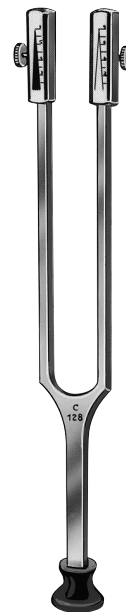

mit Dämpfer = C 64
ohne Dämpfer = C 128
with clamps = C 64
without clamps = C 128

Rydel-Seiffer

**C 64/C 128
RU 7828-00**

Stimmgabeln Tuning forks



RU 7830-05

Satz zu 5 Stimmgabeln, enthaltend:
Set of 5 tuning forks, containing:

RU 7820-02

RU 7820-03

RU 7820-04

RU 7825-02

RU 7825-03

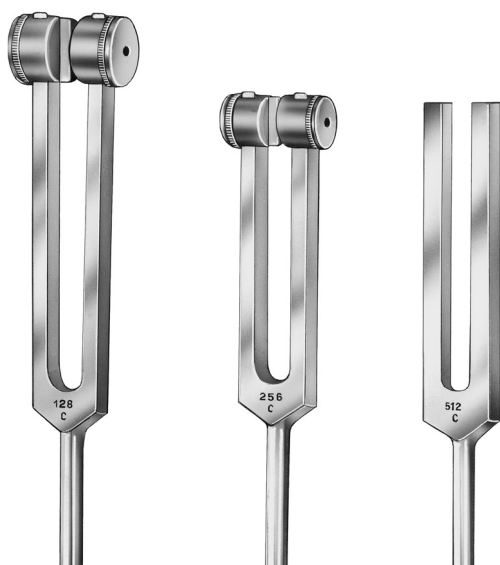

C 128
RU 7831-02

C 256
RU 7831-03

C 512
RU 7831-04

Stimmgabeln aus Spezial Aluminium-Magnesium-Legierung für medizinische Zwecke z. B. für Gehörprüfungen (Luft- und Knochenleitung), für Sensibilitätsprüfungen und andere diagnostische Zwecke.

Tuning forks made of a special aluminium-magnesium-alloy, for medical purposes, such as examination of hearing (air and bone conduction), for sensibility examinations and other diagnostic purposes.

Saugrohre, Saugadapter
Suction tubes, suction adapters



- Ø 2,5 mm
RU 7840-20
- Ø 3,0 mm
RU 7840-25
- Ø 3,5 mm
RU 7840-30
- Ø 4,0 mm
RU 7840-40
- Ø 5,0 mm
RU 7840-50

Hartmann
13,5 cm/5¼"

Saugadapter mit Saugunterbrecher
(Schlauchverbinder)
Suction adapters with cut-off
(*Tube connector*)



1/1

House
5,5 cm/2⅛
RU 7842-00



Außen Ø Outer Diam. Ø	Rosen (House)
0,5 mm	RU 7842-10
0,7 mm	RU 7842-11
0,8 mm	RU 7842-31
0,9 mm	RU 7842-12
1,0 mm	RU 7842-32
1,2 mm	RU 7842-13
1,5 mm	RU 7842-14
1,8 mm	RU 7842-18
2,0 mm	RU 7842-20
2,5 mm	RU 7842-25
3,0 mm	RU 7842-30

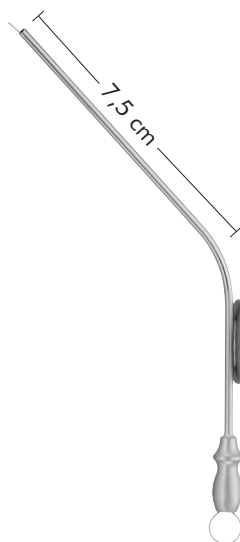

Baron
14 cm/5½"

Ømm	Charr./Fr.	
1,0	3	RU 7845-03
1,5	5	RU 7845-05
2,3	7	RU 7845-07

Olive
Ø 8 mm



Schuknecht
13 cm/5"

Ømm	Gauge	
0,9	20	RU 7845-20
0,7	22	RU 7845-22
0,5	24	RU 7845-24

Olive
Ø 8 mm

Saugrohre, Saug- und Spülkanülen
Suction tubes, suction and irrigation cannulae

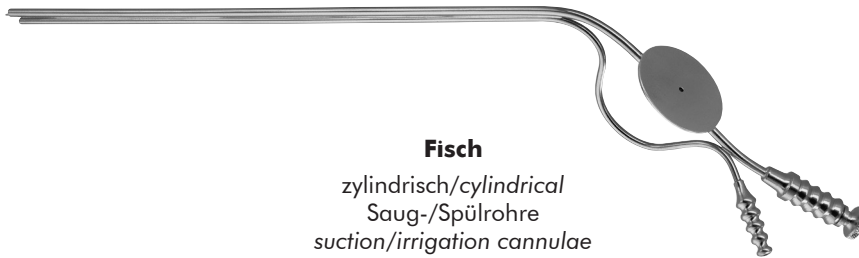

Fisch

zylindrisch/cylindrical
 Saug-/Spülrohre
 suction/irrigation cannulae

∅ Saugrohr	∅ Spülrohr
∅ Suction tube	∅ Irrigation tube

∅ 3,0 mm	
∅ 2,5 mm	
∅ 1,8 mm	

2,0 mm	
2,0 mm	
1,8 mm	

RU 7849-30
RU 7849-25
RU 7849-18

10 cm/4"



Ferguson

∅ mm	Charr./Fr.	
2,0	6	RU 6421-06
2,3	7	RU 6421-07
2,5	8	RU 6421-08
3,0	9	RU 6421-09
3,3	10	RU 6421-10
3,5	11	RU 6421-11
4,0	12	RU 6421-12
5,0	15	RU 6421-15



mit Saugunterbrecher und Mandrel
 Griffplatte parallel zur Biegung,
 LUER-Anschluss
with cut-off and stylet
thumb piece parallel to curve,
LUER connector

∅ mm	Charr./Fr.	
1,5	5	RU 6422-15
2,0	6	RU 6422-20
2,5	8	RU 6422-25
3,0	9	RU 6422-30

Plester
 19,5 cm/7 3/4"

Polypenschnürer, Polypenschlingen
Polypus snares, wire loops

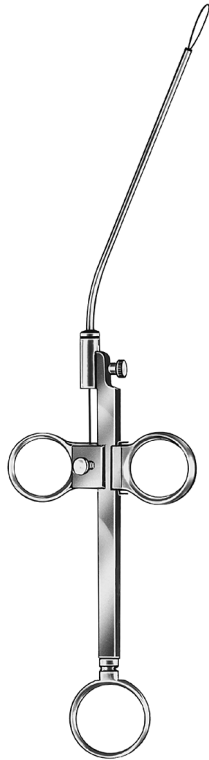

Krause
 18 cm / 7 1/4"
RU 7850-16

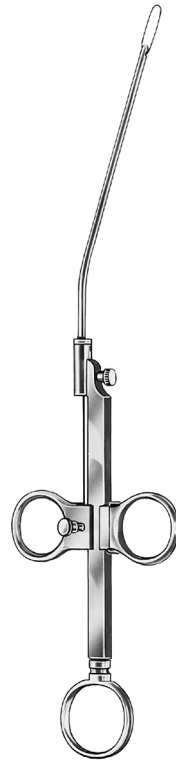

Krause-Voss
 18 cm / 7 1/4"
RU 7852-16

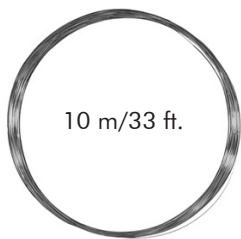

10 m / 33 ft.

Ø 0,3 mm **RU 7856-03**
 Ø 0,4 mm **RU 7856-04**



Packung à 12 Stück
 package of 1 dozen each

Ø 0,2 mm **RU 7857-02**
 Ø 0,3 mm **RU 7857-03**

Packung à 100 Stück
 package of 100 pieces each

Ø 0,3 mm **RU 7857-03/00**

Ohrzangchen, Fremdkorperheber
Ear forceps, foreign body levers



Littauer
 12 cm/4³/₄"
RU 7869-12

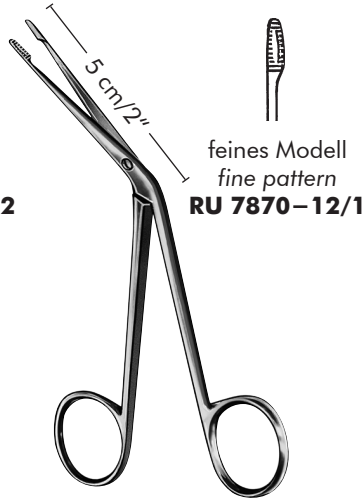

Hartmann
 12 cm/4³/₄"
RU 7870-12



Hartmann
 14 cm/5¹/₂"
 normales Modell
 standard pattern
RU 7870-14



Tilley
 14 cm/5¹/₂"
RU 7871-14



Quire
 8 cm/3¹/₄"
RU 7873-00

Ohrzängchen
Ear forceps

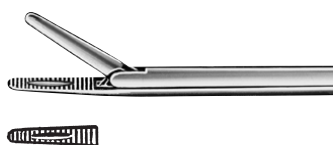

Schaftlänge
 Length of shaft
 8,5 cm/3¼"

Hartmann-Noyes
RU 7878-00



RU 7879-00



8,5 cm/3¼"
 14 cm/5½"

Hartmann
RU 7880-09
RU 7880-14

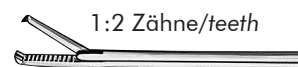

1:2 Zähne/teeth

Hartmann
RU 7881-09
RU 7881-14



8,5 cm/3¼"
 8,5 cm/3¼"
 8,5 cm/3¼"

Hartmann
RU 7882-20 ○ 2,0 mm
RU 7882-25 ○ 2,5 mm
RU 7882-30 ○ 3,0 mm



Hartmann-Citelli
RU 7883-09/02 ○ 2 mm
RU 7883-09 ○ 3 mm

Ohrzängchen
Ear forceps

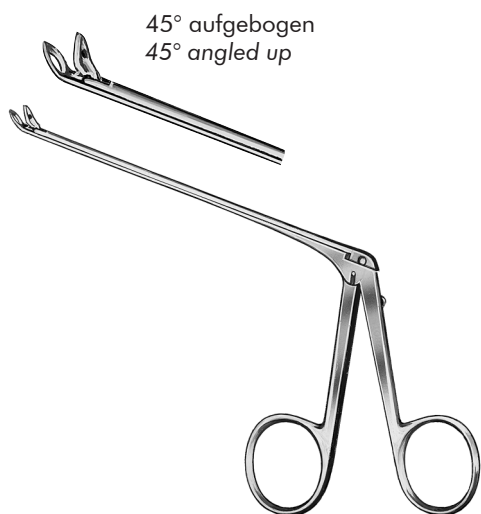

Strümpel-Voss
 11 cm
RU 7884-11



Strümpel
 8,5 cm/3³/₄" **RU 7884-09**
 10 cm/4" **RU 7884-10**



Hartmann
RU 7886-09

8,5 cm/3¹/₄"
 8,5 cm/3¹/₄"



Hartmann-Wullstein
 0,8 x 6 mm **RU 7887-06**
 1,8 x 8 mm **RU 7887-08**



Hartmann-Wullstein
 ∅ 1 mm **RU 7888-01**
 ∅ 2 mm **RU 7888-02**

8,5 cm/3¹/₄"
 8,5 cm/3¹/₄"



Hartmann
RU 7889-00











Schafflange 8 cm
 Length of shaft 8 cm

Mikrozangen
Micro Forceps

	1,6 x 7,0 mm	Mini 0,7 x 3,5 mm	Superfein superdelicate
	RU 7890-21	RU 7890-28	
	0,8 x 4,0 mm	0,6 x 4,0 mm	0,4 x 4,0 mm
Schafflange Standard 8 cm length of shaft 10 cm	RU 7890-22 RU 7890-22/10	RU 7890-29	RU 7890-35
glattes Maul smooth jaw	0,8 x 4,0 mm		
	RU 7890-23		
links gebogen curved left	0,8 x 6,0 mm	0,6 x 4,0 mm	
	RU 7890-24	RU 7890-31	
rechts gebogen curved right	0,8 x 6,0 mm	0,6 x 4,0 mm	
	RU 7890-25	RU 7890-32	
aufgebogen angled up	0,8 x 4,0 mm	0,6 x 4,0 mm	
	RU 7890-26	RU 7890-33	
abgebogen angled down	0,8 x 4,0 mm		
	RU 7890-27		

Löffelzangen, Drahtbiegezängchen
Cup-shaped forceps, wire bending forceps



Löffelzangen <i>Cup-shaped forceps</i>		Drahtbiegezängchen <i>Wire Bending Forceps</i>	
gerade <i>straight</i>	0,5 x 0,6 mm  RU 7891-11	0,9 x 1,1 mm  RU 7891-31	
links gebogen <i>curved left</i>	0,5 x 0,6 mm  RU 7891-12	0,9 x 1,1 mm  RU 7891-32	
rechts gebogen <i>curved right</i>	0,5 x 0,6 mm  RU 7891-13	0,9 x 1,1 mm  RU 7891-33	
aufgebogen <i>angled up</i>	0,5 x 0,6 mm  RU 7891-14	0,9 x 1,1 mm  RU 7891-34	
abgebogen <i>angled down</i>		0,9 x 1,1 mm  RU 7891-35	

Mc Gee

leicht nach unten gebogen
slightly curved downwards



RU 7891-45

Mikrozangen
Micro forceps

Greven

gerade/straight



RU 7891-36

Hammerkopfstanze
Malleus Nipper

oben schneidend
upwards cutting



Dieter

unten schneidend
downwards cutting

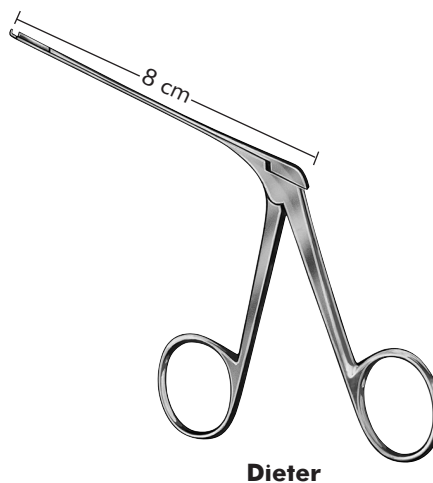



Mikroscheren
Micro scissors

Bellucci

gerade, spitz/spitz
 straight, sharp/sharp

4,0 mm



Schaftlänge 8 cm **RU 7892-11**
 length of shaft 10 cm **RU 7892-11/00**

gerade, spitz/stumpf
 straight, sharp/blunt



8 cm **RU 7892-11/01**

aufgebogen, spitz/spitz
 angled up, sharp/sharp



8 cm **RU 7892-11/02**

rechts gebogen, spitz/spitz
 curved right, sharp/sharp



8 cm **RU 7892-11/03**

links gebogen, spitz/spitz
 curved left, sharp/sharp



8 cm **RU 7892-11/04**

gerade, fein, spitz/spitz
 straight, delicate



8 cm **RU 7892-11/13**

Bellucci

gerade
 straight

5,5 mm



Schaftlänge 8 cm **RU 7892-12**
 length of shaft

aufgebogen
 angled up

5,5 mm



8 cm **RU 7892-13**

links gebogen
 curved left

5,5 mm



8 cm **RU 7892-14**

rechts gebogen
 curved right

5,5 mm



8 cm **RU 7892-15**

Shea

gerade
 straight

7,0 mm



8 cm **RU 7892-16**

links gebogen
 curved left

7,0 mm



8 cm **RU 7892-17**

rechts gebogen
 curved right

7,0 mm



8 cm **RU 7892-18**

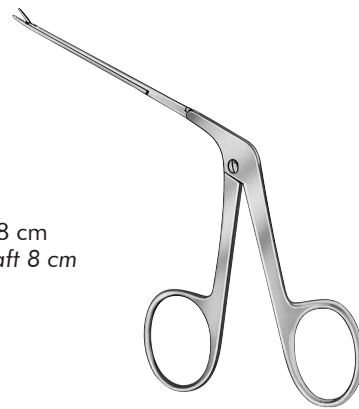

Schaftlänge 8 cm
 Length of shaft 8 cm

glattes Maul
 smooth jaw

0,5 mm

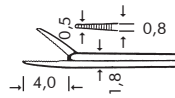

RU 7893-01/04

gerade
 straight

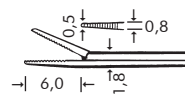

RU 7893-01/06

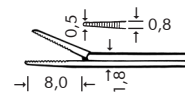

RU 7893-01/08

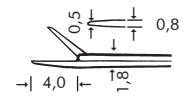

RU 7893-09/04

rechts gebogen
 curved right

RU 7893-02/04

links gebogen
 curved left

RU 7893-03/04

0,3 mm

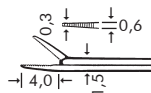

RU 7893-11/04

gerade
 straight

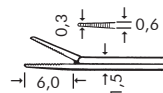

RU 7893-11/06

Mikro- Löffelzangen, -Scheren
Cup-shaped micro forceps, micro scissors



Löffelzangen
Cup-shaped forceps

Schaftlänge 8 cm
 Length of shaft 8 cm



Mikro-Scheren
Micro-Scissors

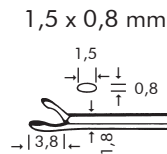

gerade
 straight

RU 7893-21/04

rechts gebogen
 curved right

RU 7893-22/04

links gebogen
 curved left

RU 7893-23/04

Belluci 3,0 mm

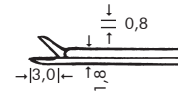

RU 7893-41/03

Belluci 4,0 mm

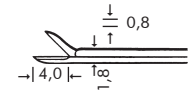

RU 7893-41/04

RU 7893-42/03

RU 7893-43/03

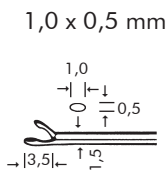

gerade
 straight

RU 7893-31/04

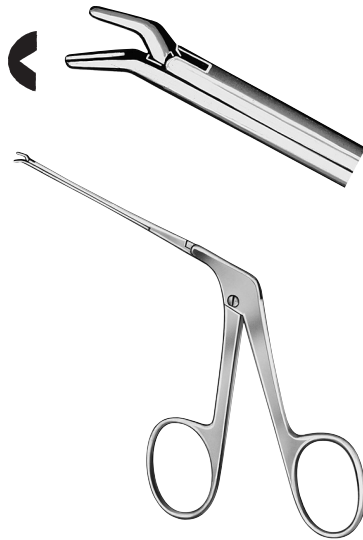

Schafflänge 8 cm
Length of shaft 8 cm

Mc Gee/Fisch
RU 7893-52

Drahtbiegezängchen
Wire / - bending forceps

Mikrozangen und Mikroscheren

Micro forceps and scissors



Schaft \varnothing 0,9 mm
Shaft \varnothing 0,9 mm

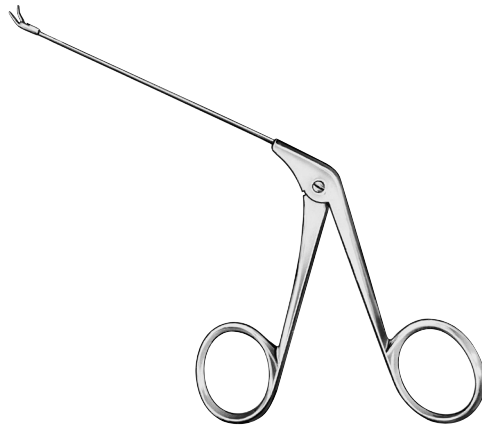

Mikrozangen Micro Forceps

gerade
straight

4 mm



8 cm/3 1/4" **RU 7894-01**

6 mm



RU 7894-03

aufgebogen
angled up



8 cm **RU 7894-02**

Löffelzangen Cup-shaped Forceps

gerade
straight



oval
oval cup jaws



\varnothing 1 mm 8 cm **RU 7894-11**
16 cm **RU 7894-51**

RU 7894-12
RU 7894-52

\varnothing 2,5 mm 16 cm **RU 7894-53**

Mikro-Scheren Micro Scissors

gerade
straight



8 cm/3 1/4" **RU 7894-21**
16 cm/6 1/4" **RU 7894-61**

aufgebogen
angled up



8 cm/3 1/4" **RU 7894-22**
16 cm/6 1/4" **RU 7894-62**

Pinzettenzängchen Heermann Finest grasping forceps

gerade
straight

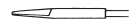

8 cm/3 1/4" **RU 7894-31**

Mikro-Scheren, Mikro-Stanzen, Mikro-Zängchen
Micro scissors, nippers, forceps



Schaft Ø 1,5 mm
 Shaft Ø 1,5 mm

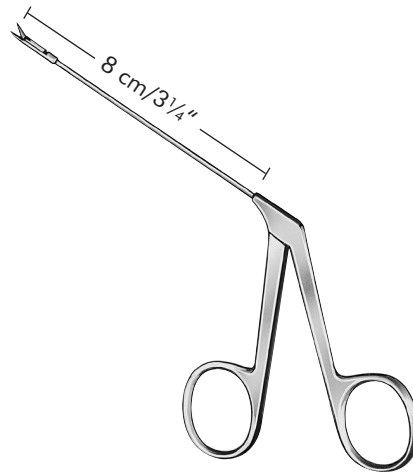

Mikroscheren
Micro scissors

gerade, spitz/spitz
 straight, sharp/sharp



RU 7894-60/01

links gebogen, spitz/spitz
 curved left, sharp/sharp



RU 7894-60/03

rechts gebogen, spitz/spitz
 curved right, sharp/sharp



RU 7894-60/04

Mikrostanzen
Micro Nippers

nach oben schneidend
 upwards cutting



RU 7894-60/10

nach unten schneidend
 downwards cutting



RU 7894-60/11

Mikro-Drahtbiegezängchen
Micro Wire Bending Forceps

nach unten gebogen
 curved down



RU 7894-60/15

nach unten gebogen
 curved down

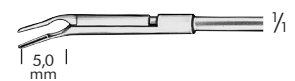

RU 7894-60/16

Mikro-Löffelzängchen
Micro cup-shaped forceps



Schaft Ø 1,5 mm
 Shaft Ø 1,5 mm

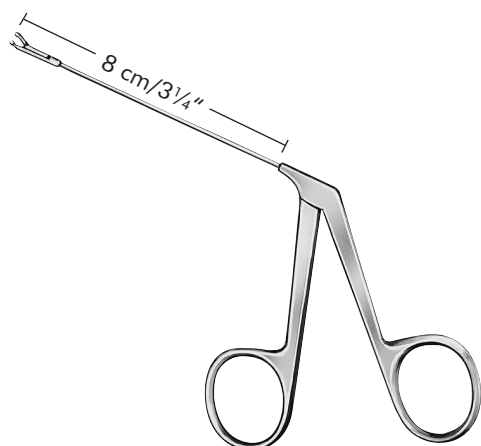

gerade, oval
straight, oval
 0,9 x 1,0 mm



RU 7894-61/01

gerade, oval
straight, oval
 0,8 x 1,3 mm



RU 7894-61/06

links gebogen, oval
curved left, oval
 0,8 x 1,3 mm

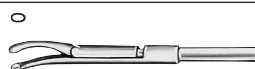

RU 7894-61/07

gerade, rund
straight, round
 Ø 1,0 mm

Wullstein



RU 7894-61/12

gerade, oval
straight, oval
 1,7 x 2,5 mm

Wullstein



RU 7894-61/16

Mikro-Zängchen
Micro forceps



Schaft \varnothing 1,5 mm
 Shaft \varnothing 1,5 mm

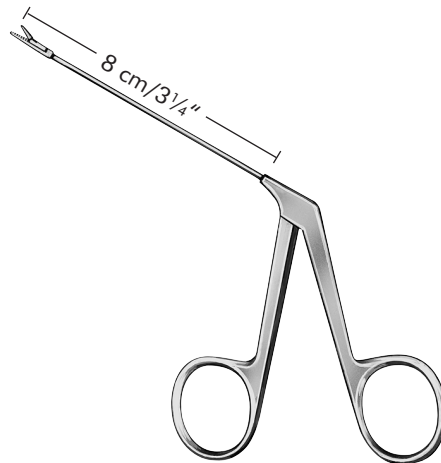

gerade
 straight
 0,8 x 3,5 mm



RU 7894-62/01

65° nach oben
 curved up 65°
 0,8 x 3,5 mm



RU 7894-62/02

gerade
 straight
 1 x 5 mm



RU 7894-62/08

links gebogen
 curved left
 1 x 5 mm



RU 7894-62/09

rechts gebogen
 curved right
 1 x 5 mm



RU 7894-62/10

gerade
 straight
 1,5 x 6 mm



RU 7894-62/14

Mikro-Scheren
Micro scissors

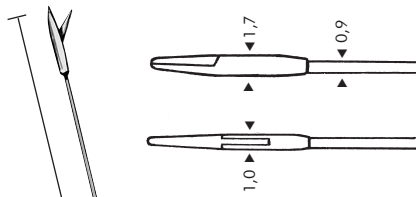

aufgebogen
angled up



RU 8860-01

Mikro-Schere
Micro Scissor

17 cm/6³/₄"



Rollmesser
parallel zum Schaft
Roller knifi
blade parallel to shaft

Schuknecht
16 cm/6¼"
RU 7906-01/01



Rollmesser
rechtwinklig zum Schaft
Roller knifi
blade right angled to shaft

Schuknecht
16 cm/6¼"
RU 7906-01/02



Wullstein
16 cm/6¼"
RU 7906-01/04



Tabb
16 cm/6¼"
RU 7906-01/05



Plester
 16 cm/6¼"

3,5 x 2,5 mm



RU 7906-01/06

4,0 x 2,0 mm



RU 7906-01/07

4,5 x 2,5 mm



RU 7906-01/08



RU 7906-02/01



RU 7906-02/02



mittlere Biegung
medium curve

RU 7906-02/03



stark gebogen
strang curve

RU 7906-02/04



0°

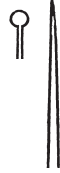

45°



90°



Ø			
1,0 mm	RU 7906-04/10	RU 7906-03/10	RU 7906-05/10
1,4 mm	—	RU 7906-03/14	—
1,5 mm	RU 7906-04/15	—	RU 7906-05/15
1,6 mm	—	RU 7906-03/16	—
2,0 mm	—	RU 7906-03/20	RU 7906-05/20
2,3 mm	—	RU 7906-03/23	—
2,5 mm	RU 7906-04/25	—	RU 7906-05/25
2,6 mm	—	RU 7906-03/26	—
2,8 mm	—	RU 7906-03/28	—
3,0 mm	—	RU 7906-03/30	—

Rosen
 16 cm/6¼"



3 mm

16 cm/6¼"
RU 7906-06/30

Rundschnittmesser für Periost
Round cutting knife for periost

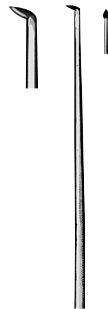

Rosen
16 cm/6¼"
RU 7906-07/16

Lanzettenmesser
Knife and elevator



Beales
17 cm/6¾"
RU 7906-08/17

Sehnenmesser
Tendon knife



Fisch
16 cm/6¼"
RU 7906-10/16

Tenotom
Tenotome



16 cm/6¼"

Wullstein
RU 7907-01/01



Wullstein
RU 7907-01/02



Wullstein
RU 7907-01/03



Wullstein
RU 7907-01/04



Fisch
 0,2 mm
RU 7907-02/02



Plester
 0,6 mm
RU 7907-02/06

0,6 mm



25°

0,3 mm **RU 7907-03/03**
 0,6 mm **RU 7907-03/06**
 1,0 mm **RU 7907-03/10**



Shambaugh

45°

0,3 mm **RU 7907-04/03**
 0,4 mm **RU 7907-04/04**
 0,6 mm **RU 7907-04/06**
 0,8 mm **RU 7907-04/08**
 1,0 mm **RU 7907-04/10**
 1,2 mm **RU 7907-04/12**
 1,5 mm **RU 7907-04/15**
 2,0 mm **RU 7907-04/20**
 2,5 mm **RU 7907-04/25**



Shambaugh

90°

0,3 mm **RU 7907-05/03**
 0,4 mm **RU 7907-05/04**
 0,6 mm **RU 7907-05/06**
 0,8 mm **RU 7907-05/08**
 1,0 mm **RU 7907-05/10**
 1,2 mm **RU 7907-05/12**
 1,5 mm **RU 7907-05/15**
 2,0 mm **RU 7907-05/20**
 2,5 mm **RU 7907-05/25**

1,0 mm **RU 7907-06/10**





16 cm/6¼
RU 7907-07/16



Fisch

16 cm/6¼"

- Ø 0,3 mm **RU 7907-08/03**
- Ø 0,4 mm **RU 7907-08/04**
- Ø 0,5 mm **RU 7907-08/05**
- Ø 0,6 mm **RU 7907-08/06**

Perforator
 Perforator



Plester

16 cm/6¼
RU 7907-09/45

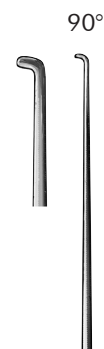

Plester

16 cm/6¼
RU 7907-09/90

Antrumhäkchen
 Antrum hook



16 cm/6¼"



90°

- 0,3 mm **RU 7907-10/03**
- 0,6 mm **RU 7907-10/06**
- 1,0 mm **RU 7907-10/10**



90°

- 0,3 mm **RU 7907-11/03**
- 0,6 mm **RU 7907-11/06**
- 1,0 mm **RU 7907-11/10**



16 cm/6¼"



Barbara
RU 7907-15/01



Rosen
RU 7907-16/01



25°

0,3 mm **RU 7907-18/03**
 0,6 mm **RU 7907-18/06**
 1,0 mm —



25°

0,3 mm —
 0,6 mm **RU 7907-19/06**
 1,0 mm —



45°

0,3 mm **RU 7907-20/03**
 0,6 mm **RU 7907-20/06**
 1,0 mm **RU 7907-20/10**



45°

0,3 mm **RU 7907-21/03**
 0,6 mm **RU 7907-21/06**
 1,0 mm **RU 7907-21/10**

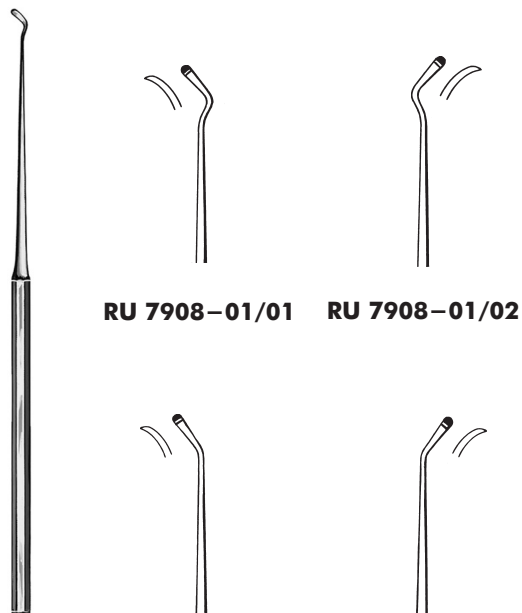

RU 7908-01/01 **RU 7908-01/02**

Fisch **RU 7908-01/03** **RU 7908-01/04**

16 cm/6¼
 Dissektoren
 Dissectors

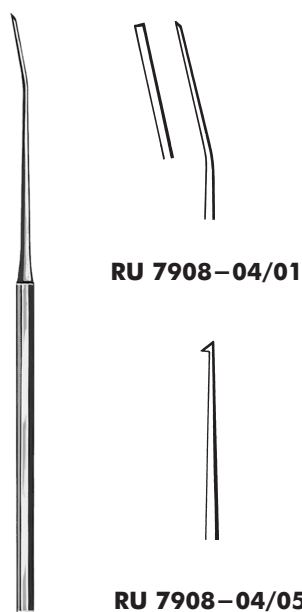

RU 7908-04/01

RU 7908-04/05

Rosen

16 cm/6¼

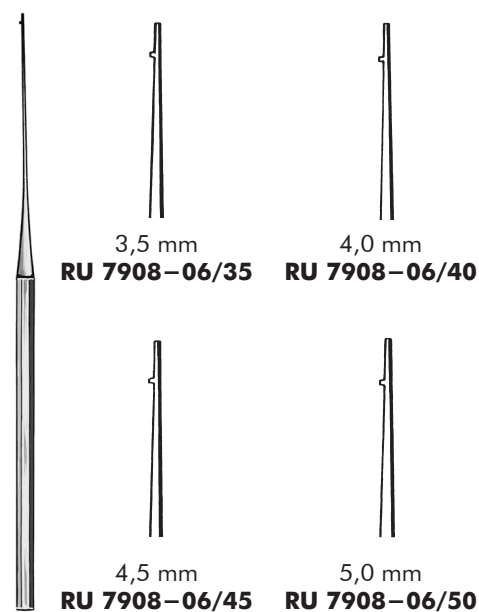

3,5 mm
RU 7908-06/35

4,0 mm
RU 7908-06/40

4,5 mm
RU 7908-06/45

5,0 mm
RU 7908-06/50

House

16 cm/6¼"
 Meßsonden
 Measuring rods

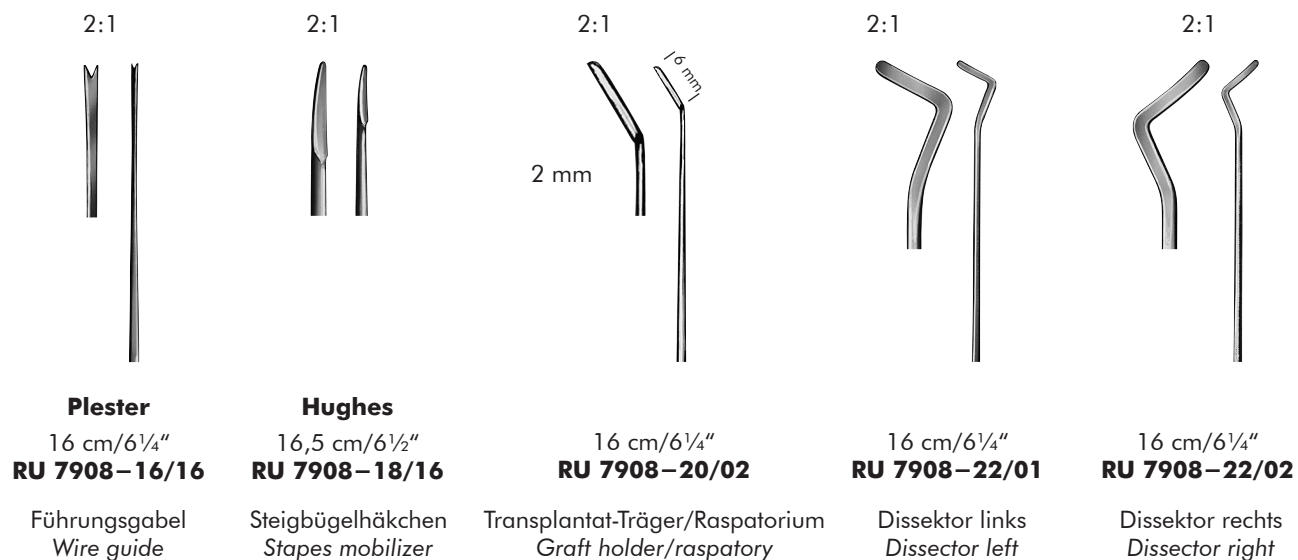
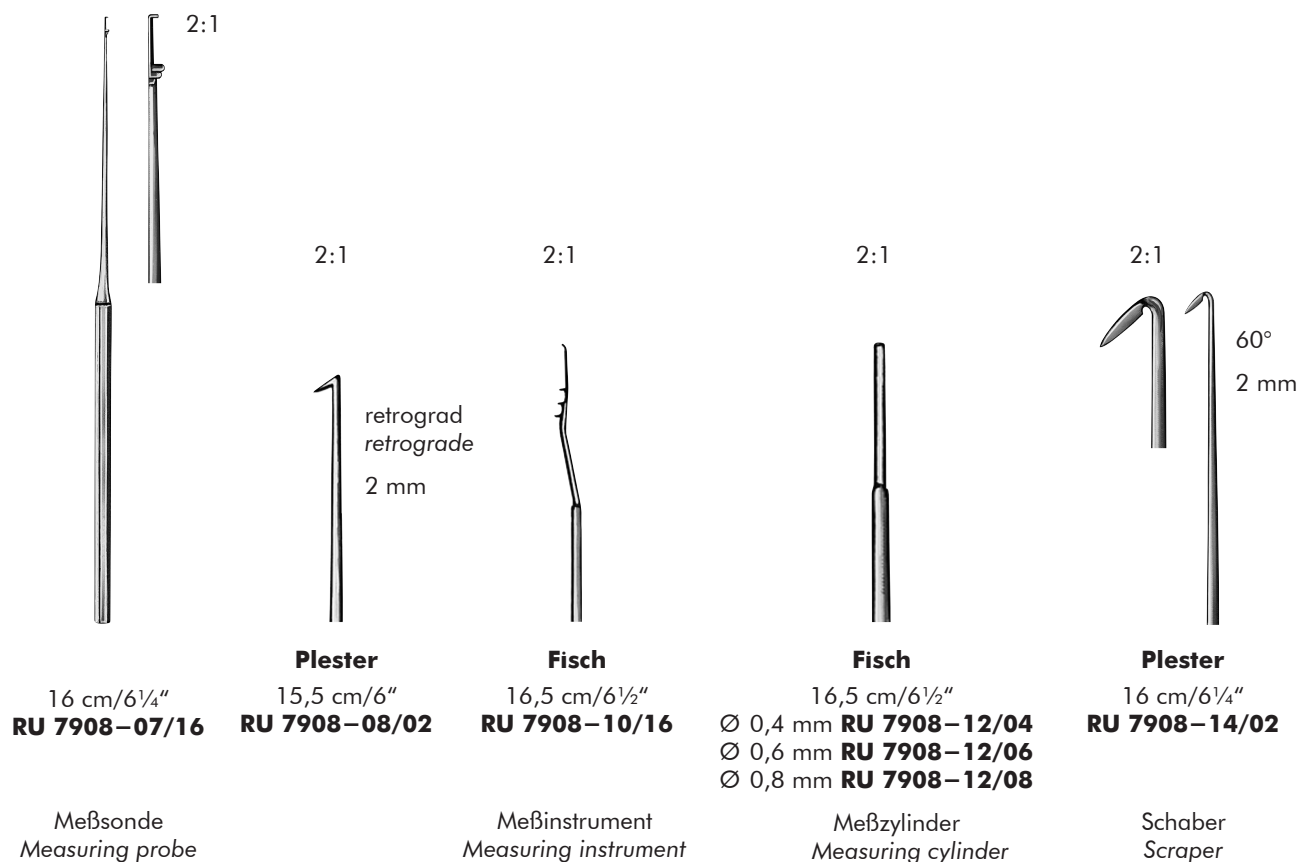

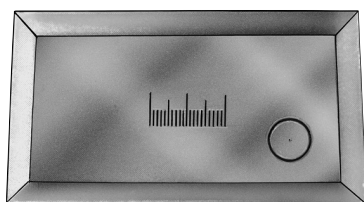

92 x 54 mm
RU 7908-90
 Präpariertablett aus Metall
 Preparation tray of metal

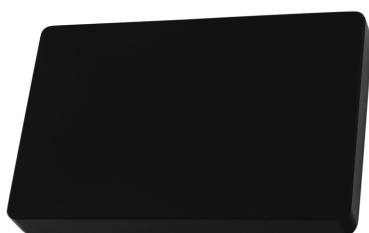

85 x 55 x 10 mm
RU 8278-10
 Knorpelschneidblock aus PPSU schwarz
 Cartilage cutting block of PPSU black

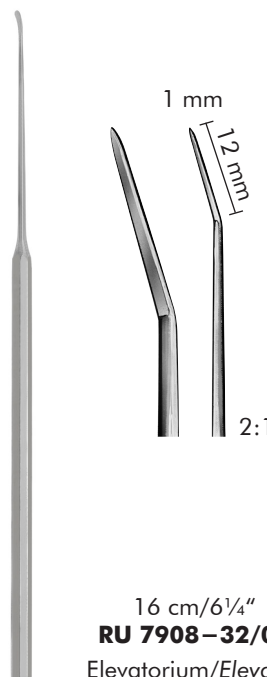

16 cm/6¼"
RU 7908-32/01
 Elevatorium/Elevator



16 cm/6¼"
RU 7908-34/18
 Raspatorium/Raspatory



Beales
 16 cm/6¼"
RU 7908-38/16

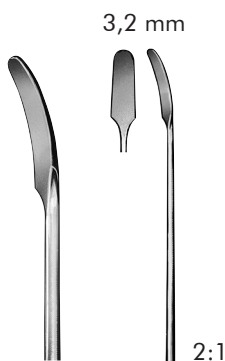

Wullstein
 16 cm/6¼"
RU 7908-40/32
 Raspatorien/Raspatories

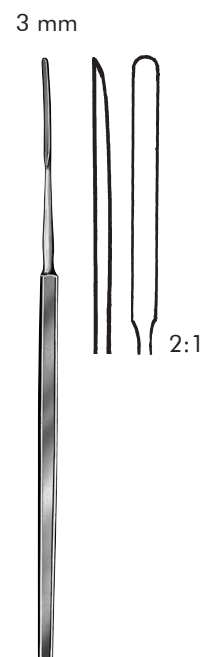

Lempert
 16 cm/6¼"
RU 7908-42/30



House

15 cm/6¼"
1,0/1,2 mm **RU 7909-10/10**
1,5/1,8 mm **RU 7909-10/15**



House

15 cm/6¼"
1,0/1,2 mm **RU 7909-11/10**
1,5/1,8 mm **RU 7909-11/15**

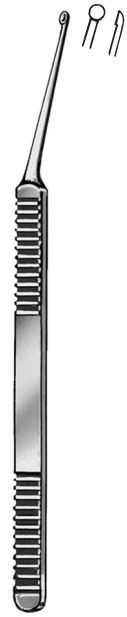







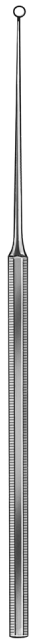





Shea

16 cm/6¼"
1,5 mm **RU 7909-12/15**

Küretten, Löffel, Schlingen
Curettes, spoons, loops



								
	Fig. 000	00	0	1	2	3	4	5
stumpf blunt 	RU 7900-30	RU 7900-20	RU 7900-10	RU 7900-01	RU 7900-02	RU 7900-03	RU 7900-04	—
scharf sharp 	RU 7902-30	RU 7902-20	RU 7902-10	—	RU 7902-02	RU 7902-03	RU 7902-04	RU 7902-05
stumpf blunt 	RU 7903-30	RU 7903-20	RU 7903-10	RU 7903-01	RU 7903-02	RU 7903-03	RU 7903-04	—
scharf sharp 	—	RU 7904-20	RU 7904-10	RU 7904-01	RU 7904-02	RU 7904-03	—	—

Buck

16,5 cm/6½"



Langenbeck
 13 cm/5⅛"
RU 7915-13



Shapleigh
 13 cm/5⅛"



RU 7916-01



RU 7916-02



Jansen
 15 cm/6"
RU 7921-15



Barth
 18 cm/7"
RU 7922-18



Billeau
 16,5 cm/6½"



RU 7932-01



RU 7932-02



RU 7932-03



Snellen
 16 cm/6¼"



RU 7933-00



RU 7933-01



RU 7933-02



Gross
12 cm/4³/₄"
RU 7934-01



Musgrove
18 cm/7"
RU 7936-01



Zaufal
16 cm/6¹/₄"
RU 7939-16



Lucae
14 cm/5¹/₂"



RU 7945-01



RU 7945-02



RU 7945-03



Wagener
14 cm/5¹/₂"



RU 7946-01



RU 7946-03



RU 7946-05



RU 7946-02



RU 7946-04



RU 7946-06



15,5 cm/6"
Day
RU 7947-03



16 cm/6¹/₄"
Day



RU 7949-01



RU 7949-02



Zaufal-Jansen
15 cm/6"
RU 7950-01

Messer, Myringotome, Parazentesenadeln
Knives, myringotomes, paracentesis needles



Politzer
 16 cm/6¼"
RU 7960-16



Sexton
 18 cm/7"
 gerade
 straight

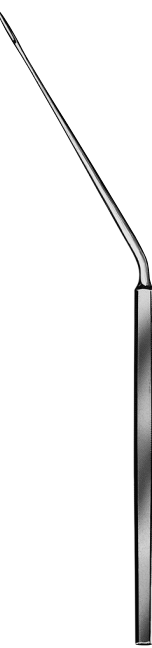

Sexton
 17 cm/6¾"
 gebogen
 curved

RU 7962-01	1	RU 7963-01
RU 7962-02	2	RU 7963-02



Politzer
 16 cm/6½"
RU 7966-01

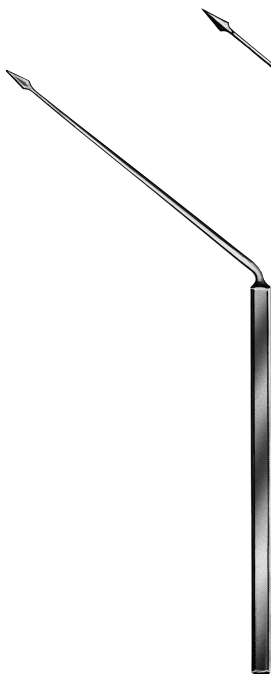

Politzer
 16,5 cm/6½"
RU 7971-16
 Parazentesenadel
 Tympanum perforator

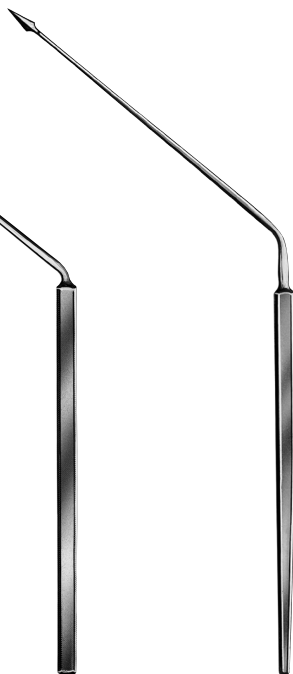

Agnew (Politzer)
 17,5 cm/7"
RU 7972-17
 Myringotom
 Myringotome



Lucae
 16 cm/6¼"
RU 7974-16
 Parazentesenadeln
 Tympanum perforator



Lucae
 18 cm/7"
RU 7974-18
 Parazentesenadeln
 Tympanum perforator

Lucae
 18 cm/7"
RU 7975-18
 Parazentesenadel für Kinder
 Tympanum perforator for children

Myringotome, Parazentesenadeln, Nierenschale
Myringotomes, paracentesis needles, kidney bowl

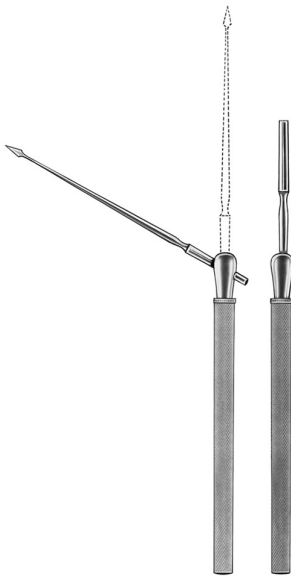

Politzer
17 cm/6¾"
RU 7976-01

Myringotom
Myringotome



16 cm/6¼"
RU 7978-01



16 cm/6¼"

Parazentesenadeln
Tympanum perforator



RU 7980-01

Nierenschale
Kidney bowl



250 x 140 x 40 mm
RU 8970-02



Präparierscheren	<i>Dissecting Scissors</i>	187 — 188
Feine Scheren	<i>Fine Scissors</i>	189, 192— 194
Nasenscheren	<i>Nasal Scissors</i>	190 — 191
Arterienklemmen	<i>Artery Sorceps</i>	195
Sinusklemmen	<i>Sinus Sorceps</i>	196
Anatomische und chirurgische Pinzetten	<i>Dressing and Tissue Forceps</i>	197
Feine Pinzetten, atraumatische Pinzetten	<i>Fine Forceps, Atraumatic Forceps</i>	198
Nasenpinzetten, Fasspinzetten	<i>Nasal Forceps, Grasping Forceps</i>	199
Watteträger	<i>Cotton Applicators</i>	200
Nasenspekula	<i>Nasal Specula</i>	201 — 211
Flexibler Spannarm für Nasenspekula	<i>Flexible Arm for Nasal Specula</i>	209
Polypenschnürer, Schnürerdraht	<i>Nasal Snares, Snare Wire</i>	212
Nasenpinzetten	<i>Nasal Forceps</i>	213
Nasentamponzangen, Septumzangen	<i>Nasal Dressing Forceps, Septum Forceps</i>	214
Polypenzangen, Septumzangen	<i>Polypus Forceps, Septum Forceps</i>	215
Septumzangen, Löffelzängchen	<i>Septum Forceps, Cup Shaped Forceps</i>	216
Siebbeinzangen	<i>Ethmoidal Forceps</i>	217, 219 — 220
Septumzangen, Biopsie- und Fasszangen	<i>Septum Forceps, Biopsy and Grasping Forceps</i>	218
Conchotome	<i>Nasal Cutting Forceps</i>	221
Septumzangen, Septumscheren	<i>Septum Forceps, Septum Scissors</i>	222
Keilbeinstanzen	<i>Sphenoidal Punches</i>	223
Nasenplastikmesser	<i>Rhinoplastic and Nasal Knives</i>	224
Nasenplastikmesser, Ritzmesser	<i>Rhinoplastic and Nasal Knives</i>	225
Septummesser	<i>Septum Knives</i>	226
Septum - Elevatorien, Raspatorien	<i>Septum Elevators, Raspatories</i>	227 — 229
Raspatorien, Elevatorien	<i>Raspatories, Elevators</i>	230 — 231
Osteotome, Flach- und Hohlmeißel	<i>Osteotomes, Chisels and Gouges</i>	232 — 234
Septum - Meißel, Osteotome	<i>Septum Chisels, Osteotomes</i>	235 — 237
Osteotome, Hämmer	<i>Osteotomes, Mallets</i>	237
Nasensägen	<i>Nasal Saws</i>	238
Nasenraspeln	<i>Nasal Rasps</i>	239 — 243



Knochen-Knorpelquetsche, Metalltablett, Knorpelschneidblock	<i>Bone Crusher, Preparation Tray, Cartilage cutting block</i>	243
Haken, Gewebekralle, Fadengabel	<i>Hooks, Tissue Pick, Suture Pusher and Knot Tier</i>	244 — 250
Haken, Nasenfrakturaufrichter	<i>Hooks, Septum Elevators</i>	250
Repositionszangen, Septumrichtzangen	<i>Reposition Forceps, Septum Straightening Forceps</i>	251 — 252



Baby-Metzenbaum
 gerade/straight 11,5 cm/4½"
RU 1280-11



gebogen/curved
RU 1281-11



Metzenbaum-Fino
 14,5 cm/5¾"
 gebogen/curved
RU 1291-14



Metzenbaum
 14,5 cm/5½"
 gerade/straight
RU 1301-14

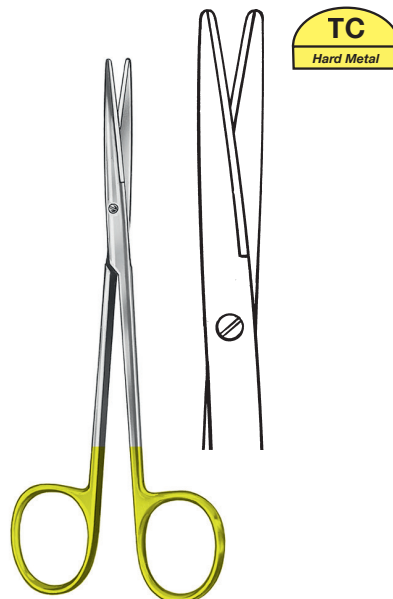

Metzenbaum
 14,5 cm/5½"
RU 1304-14

Präparierscheren
Dissecting scissors



Metzenbaum
14,5 cm/5½"
gebogen/curved
RU 1311-14

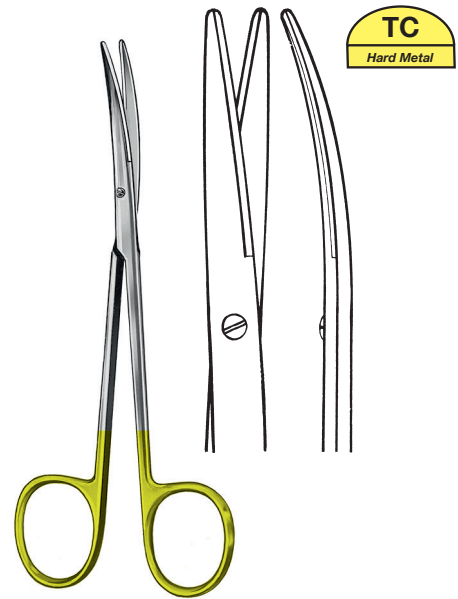

Metzenbaum
14,5 cm/5½"
gebogen/curved
RU 1314-14



Metzenbaum
18 cm/7"
gebogen/curved
RU 1331-18



Metzenbaum
18 cm/7"
gebogen/curved
RU 1334-18

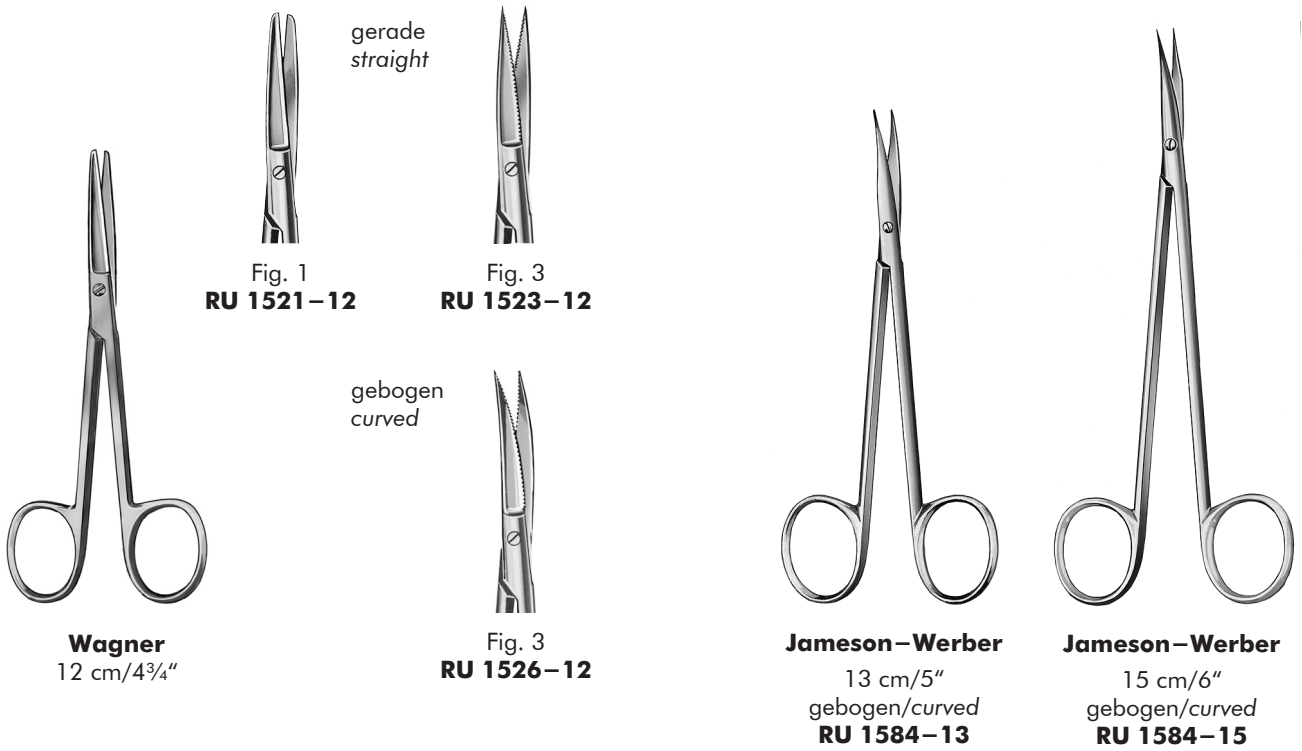



Heymann
18 cm/7"
RU 2115-18



Heymann
18 cm/7"
gezahnt/saw edge
RU 2115-18M



Fomon
13 cm/5"
RU 2130-13



Fomon
13,5 cm/5½"
schlank/gezahnt
delicate/serrated
RU 2131-13



Fomon
13 cm/5"
extra schlank/delicate
RU 2131-13M



Fomon
13,5 cm/5¼"
RU 2132-13



Fomon
13 cm/5"
RU 2132-13M



Cottle
16 cm/6¼"
RU 2136-16



Cottle
16 cm/6¼"
gezahnt/serrated
RU 2135-16M





gerade/straight
 11,5 cm/4½"
RU 2406-11



gebogen/curved
 11,5 cm/4½"
RU 2407-11



Fino
 gerade/straight
 10,5 cm/4¼" **RU 2418-10**
 11,5 cm/4½" **RU 2418-11**



Fino
 gebogen/curved
 10,5 cm/4¼" **RU 2419-10**
 11,5 cm/4½" **RU 2419-11**



	gerade/straight	gebogen/curved	Fino gerade/straight	Fino gebogen/curved
9,5 cm/3¾"	RU 2420-09	RU 2421-09	RU 2422-09	RU 2423-09
10,5 cm/4¼"	RU 2420-10	RU 2421-10	RU 2422-10	RU 2423-10
11,5 cm/4½"	RU 2420-11	RU 2421-11	RU 2422-11	RU 2423-11



Stevens

10,5 cm/4¼"

11,5 cm/4½"

Sehnenscheren

Tenotomy scissors



gerade, spitz
straight, pointed

RU 2430-10

RU 2430-11



gebogen, spitz
curved, pointed

RU 2431-10

RU 2431-11



gerade, stumpf
straight, blunt

RU 2440-10

RU 2440-11



gebogen, stumpf
curved, blunt

RU 2441-10

RU 2441-11



Graefe
 10,5 cm/4¼"
RU 2455-10



gerade/straight
RU 2460-11

11,5 cm/4½"

gebogen/curved
RU 2461-11



TC
 Hard Metal

gerade/straight
RU 2462-11

11,5 cm/4½"



TC
 Hard Metal

gebogen/curved
RU 2463-11



9,5 cm/3¾"
 gebogen
 curved
RU 2476-03

Arterienklemmen
Artery forceps

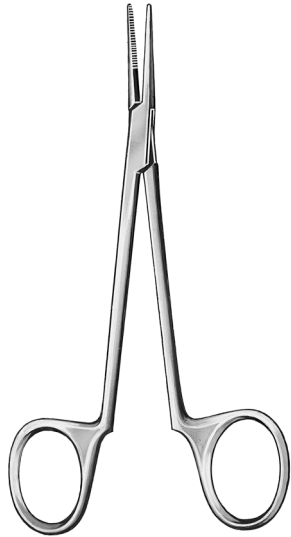

14 cm/5½"

gerade/straight
RU 3068-14



Crile
 14 cm/5½"

gebogen/curved
RU 3069-14



RU 3070-14

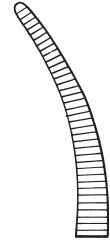

RU 3071-14



Providence
 14 cm/5½"



RU 3090-14



RU 3091-14

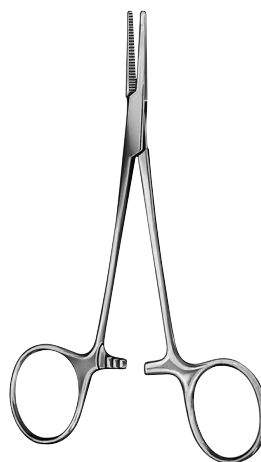

Halsted-Mosquito
 12 cm/4¾"



RU 3100-12



RU 3101-12



RU 3110-12



RU 3111-12

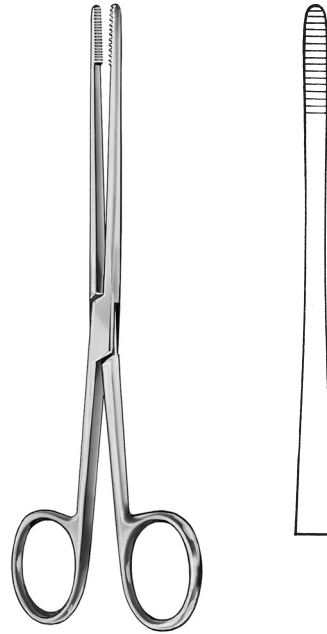

Lister

12,5 cm/5"	RU 3810-12
16,0 cm/6"	RU 3810-16
18,0 cm/7"	RU 3810-18

Anatomische und chirurgische Pinzetten
Dressing and tissue forceps



Cottle
 15 cm/6"
RU 4026-15



**Adson
 Standard**



Adson



12 cm/4 ³ / ₄ "	RU 4035-12	RU 4036-12
15 cm/6"	RU 4035-15	RU 4036-15

↔



Micro-Adson



↔

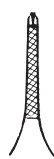

1:2

↔



**Adson
 Standard**

12 cm/4 ³ / ₄ "	RU 4130-12	RU 4130-22	RU 4135-12
15 cm/6"	RU 4130-15	RU 4130-25	RU 4135-15

Feine Pinzetten, atraumatische Pinzetten
Fine forceps, atraumatic forceps

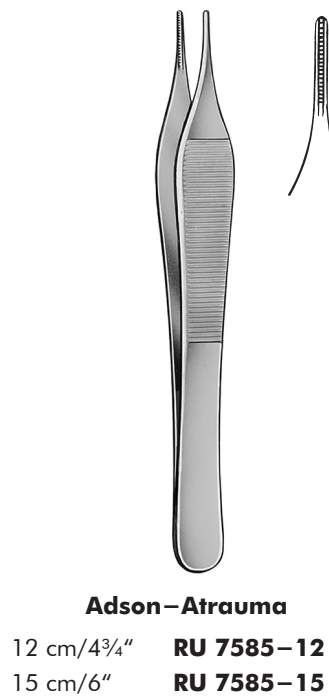
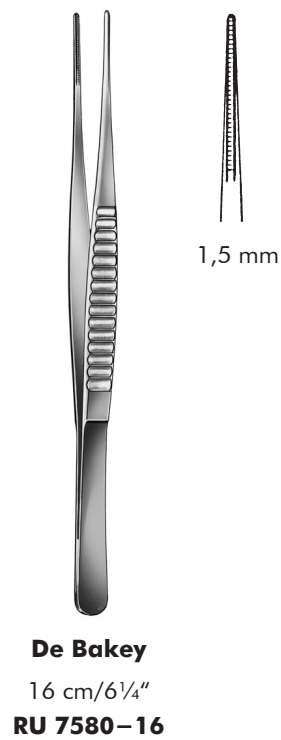
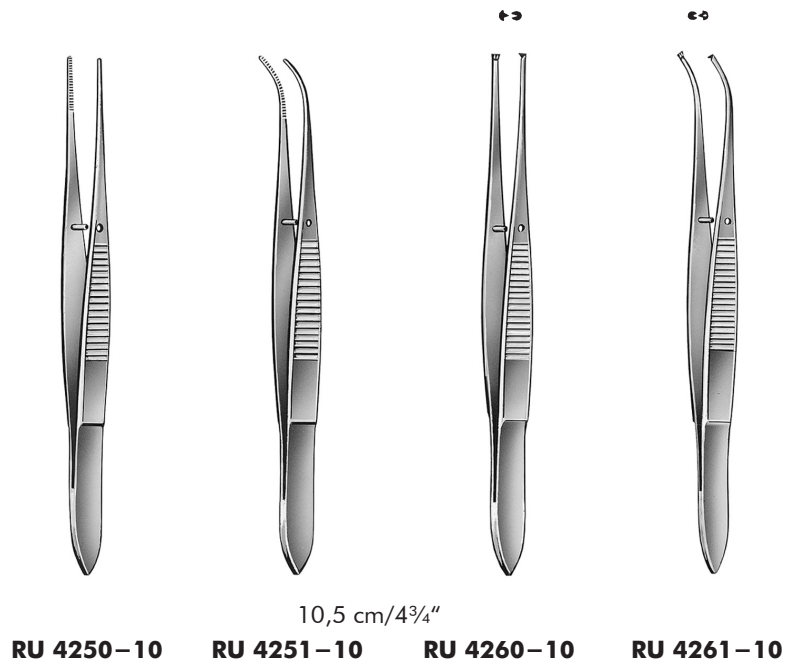

Nasenpinzetten, Fasspinzetten
Nasal forceps, grasping forceps

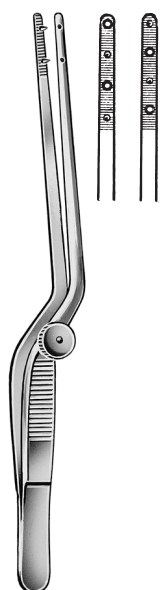

Cottle
 15 cm/6"
RU 7863-15

2,2 mm



**Jansen
 (Gruenwald)**

1 mm



**Jansen
 (Fine)**

16 cm/6¼"	RU 7864-16	RU 7864-26
18 cm/7"	RU 7864-18	RU 7864-28
20 cm/8"	RU 7864-20	RU 7864-30



Cottle
 10 cm/4"
RU 8312-10



ohne Schloß
without spring catch

RU 9942-11

mit Schloß
with spring catch

RU 9943-11

Graefe
 11 cm/4½"



Zahnbreite
Width of teeth
 0,5 mm

Castroviejo
 10 cm/4"
RU 9964-05



Universal

		Ø 1,2 mm	Ø 1,5 mm	Ø 1,7 mm
12,5 cm 5"	RU 4930-12	—	—	—
16,0 cm 6¼"	RU 4930-16	—	—	—
18,0 cm 7"	—	RU 4931-18	RU 4932-18	



spiralförmig
 spiral threads

Frohn

Ø 1,0 mm

12 cm/4¾"	RU 4934-01
14 cm/5½"	RU 4934-02
16 cm/6¼"	RU 4934-03

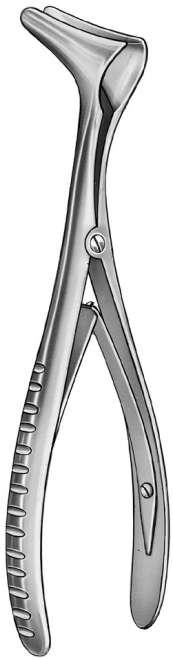

RU 8000-01

RU 8000-02

RU 8000-03

Hartmann
 15 cm/6"

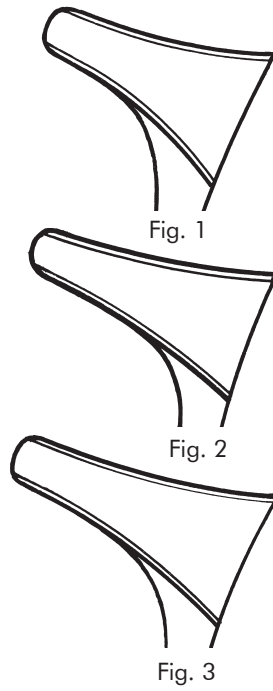

RU 8000-11

RU 8000-12

RU 8000-13

zerlegbar
 dismantable

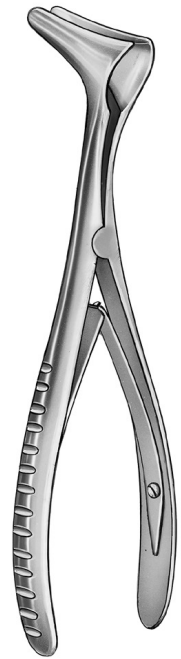

Hartmann
 15 cm/6"



RU 8002-00

RU 8002-01

RU 8002-02

RU 8002-03

Hartmann-Halle
 15 cm/6"

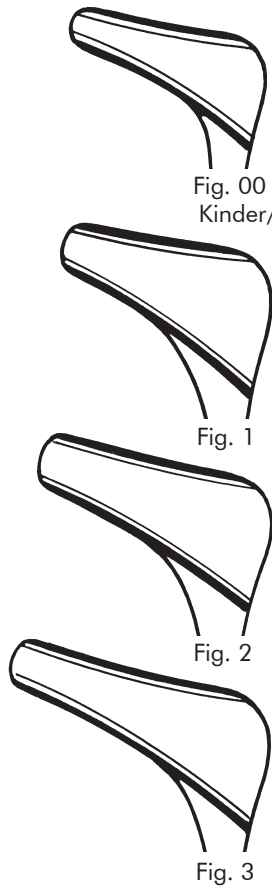

RU 8002-10

RU 8002-11

RU 8002-12

RU 8002-13

zerlegbar
 dismantable

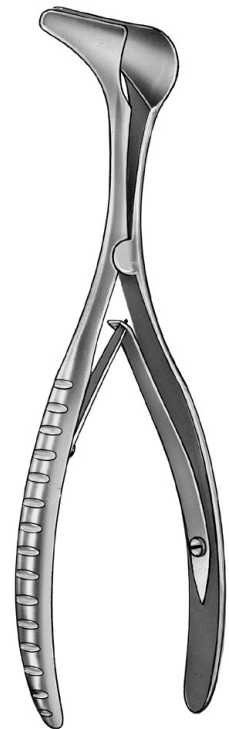

Hartmann-Halle
 15 cm/6"



Tieck
13 cm/5"

RU 8004-01

Fig. 1



Säuglinge/
infants

RU 8004-11



zerlegbar
dismountable

Tieck
13 cm/5"

RU 8004-02

Fig. 2



Kinder/
children

RU 8004-12



Beckmann
15 cm/6"
13 cm/5"

Fig. 00

RU 8005-00



Säuglinge/
infants

Fig. 1

RU 8005-01



Fig. 2

RU 8005-02

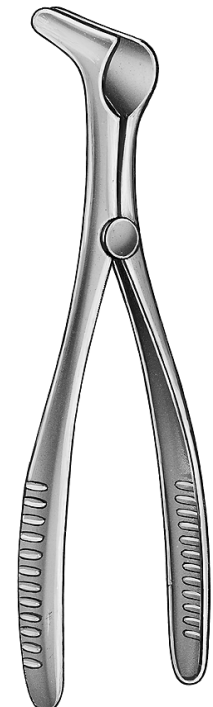
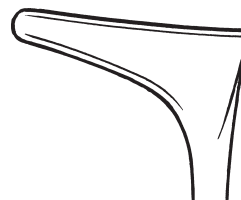

Fig. 3

RU 8005-03



Säuglinge/infants



Hartmann
14,5 cm/5¾"
leichtes Modell
light pattern
RU 8009-00



Mod. Wien
13 cm/5"

RU 8010-01

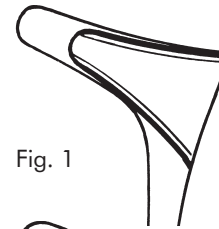

Fig. 1

RU 8010-02

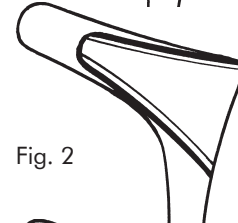

Fig. 2

RU 8010-03

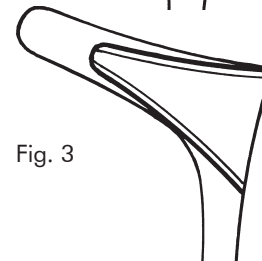
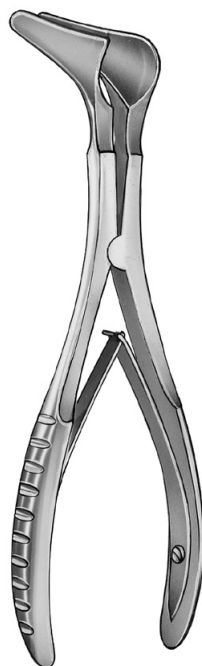

Fig. 3



Mod. Wien
13 cm/5"

zerlegbar
dismountable

RU 8011-11

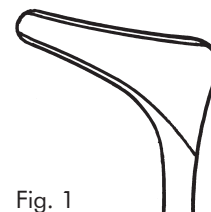

Fig. 1

RU 8011-12

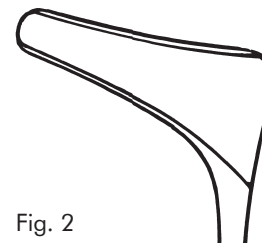
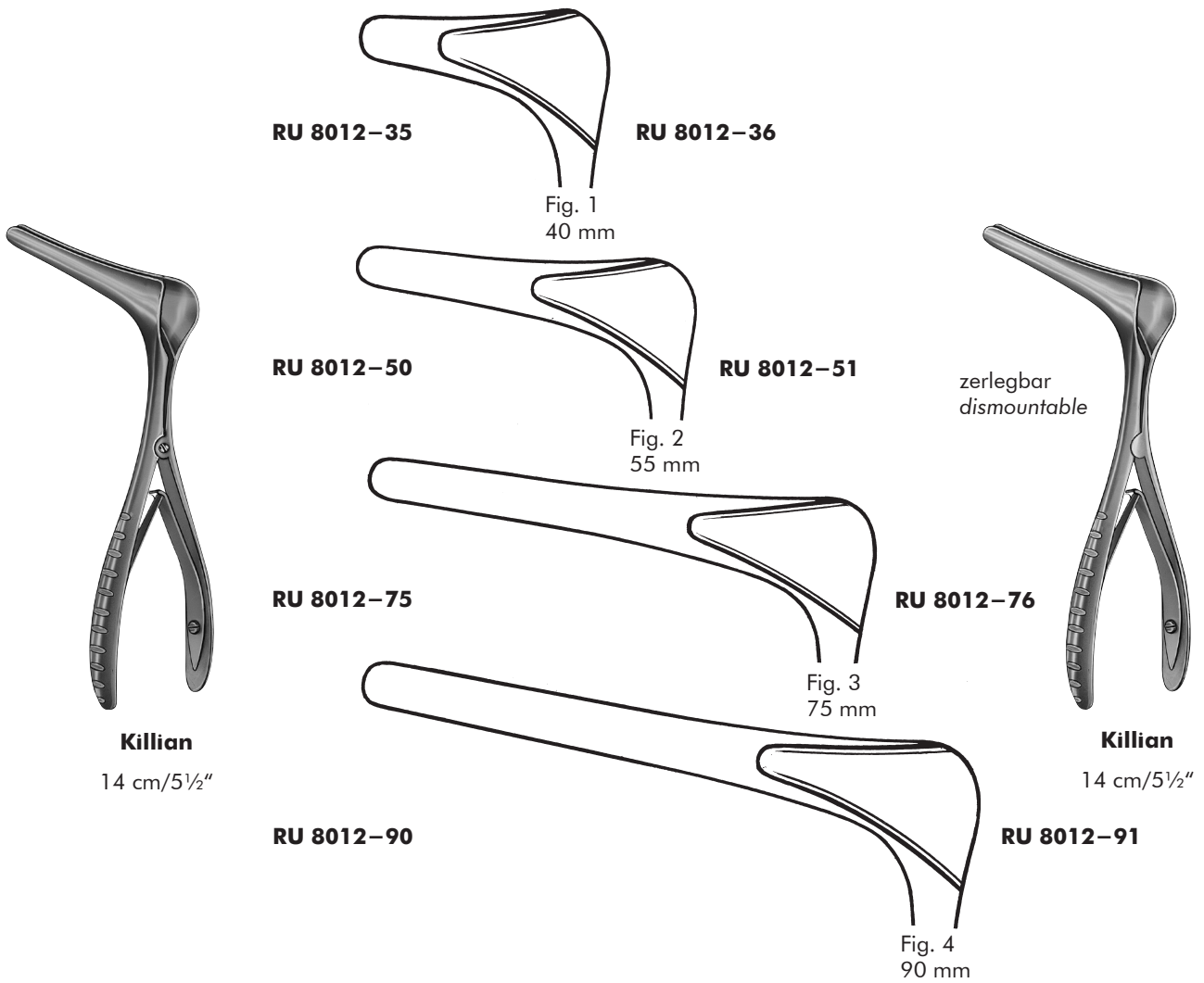

Fig. 2





zerlegbar
dismantable

Killian

14 cm/5½"
rechtes Blatt verkürzt
right blade shortened
RU 8012-83

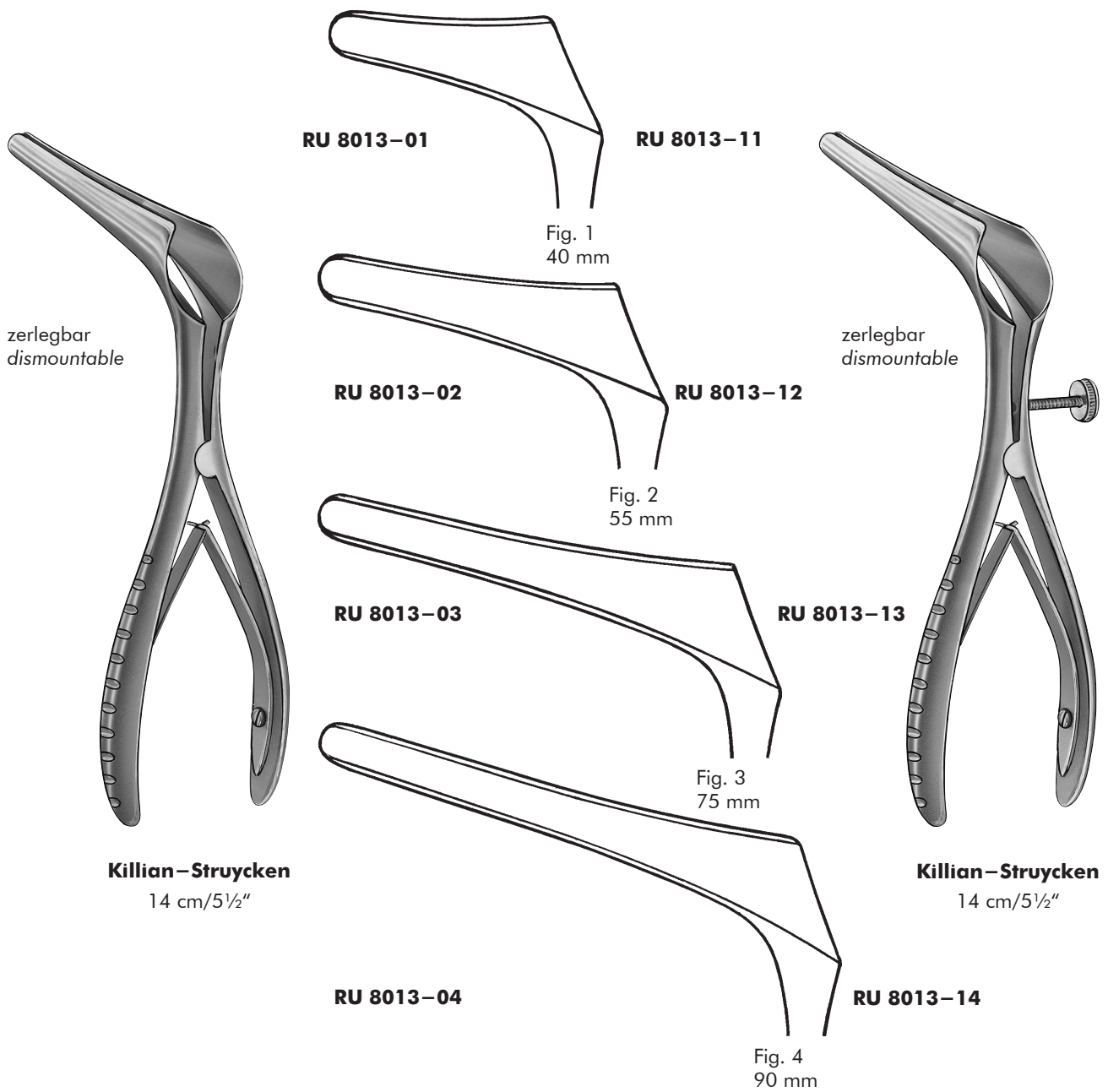

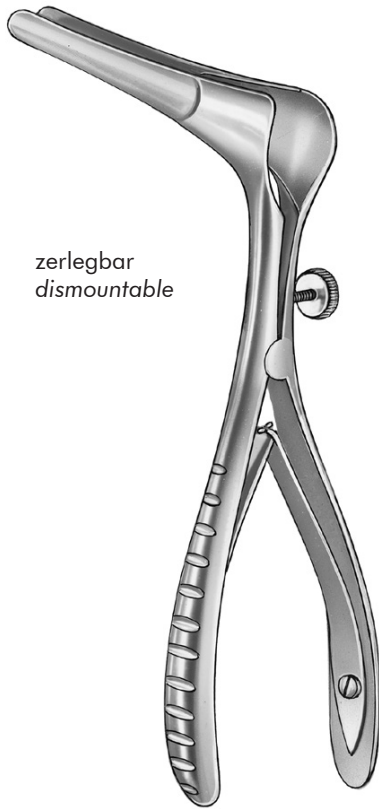

zerlegbar
dismountable

Killian-Walter
14 cm/5½"
dünnes Blatt/thin blade

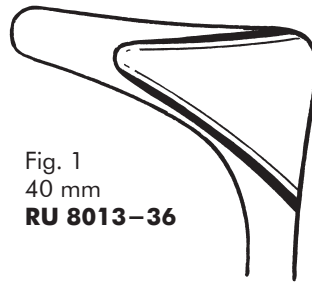

Fig. 1
40 mm
RU 8013-36

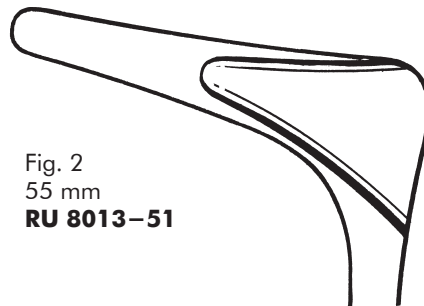

Fig. 2
55 mm
RU 8013-51

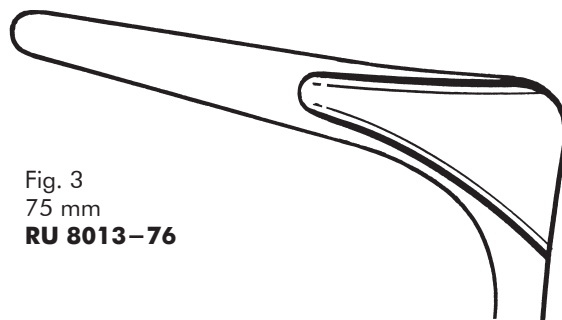

Fig. 3
75 mm
RU 8013-76

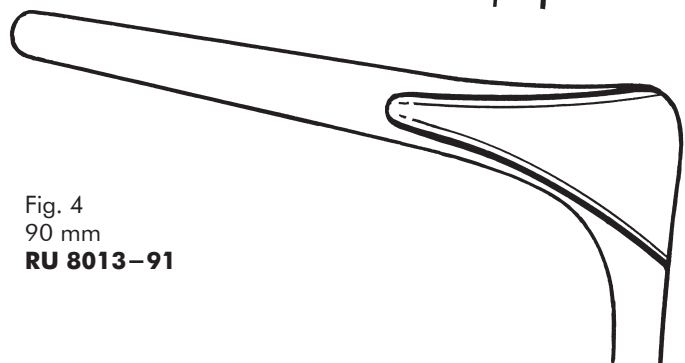

Fig. 4
90 mm
RU 8013-91

Nasenspekula
Nasal specula



zerlegbar
dismountable



zerlegbar
dismountable

Cottle
15 cm/6"

RU 8014-36
RU 8014-51
RU 8014-76
RU 8014-91

Fig. 1
Fig. 2
Fig. 3
Fig. 4

RU 8015-36
RU 8015-51
RU 8015-76
RU 8015-91

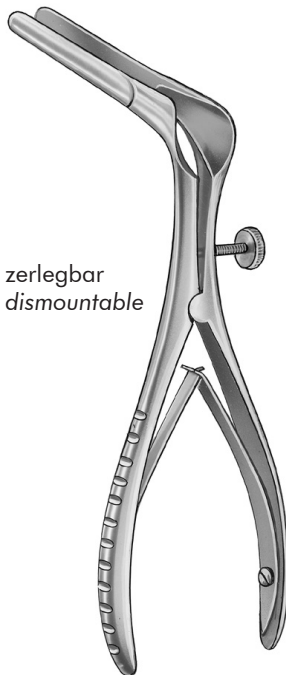
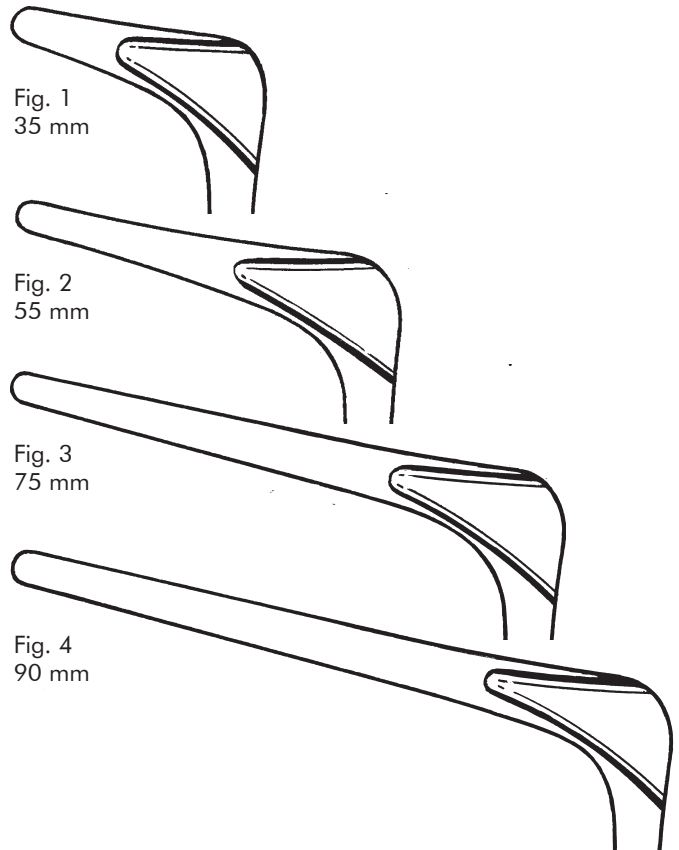

zerlegbar
dismountable

Cottle-Walter

13 cm/5"
extrem dünnes Blatt
very thin blade

RU 8016-36

RU 8016-46

RU 8016-51

RU 8016-76

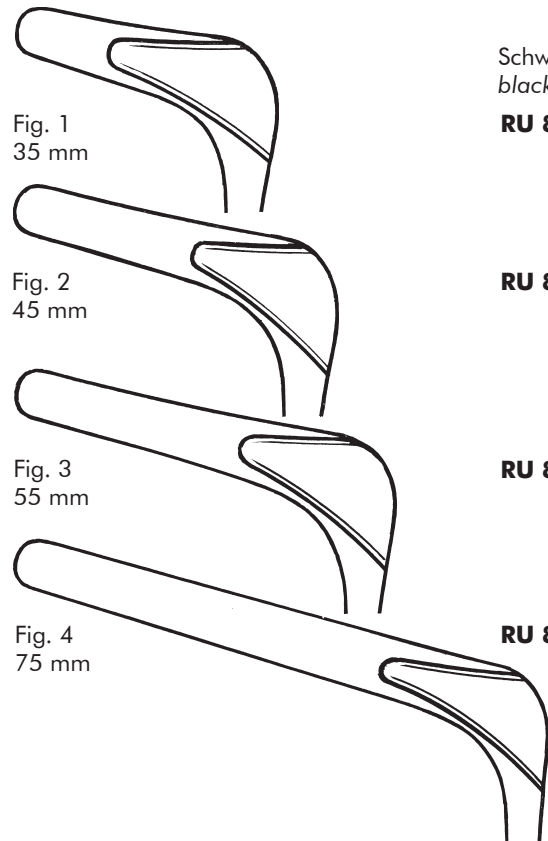

Schwarz
black finish

RU 8016-36B

RU 8016-46B

RU 8016-51B

RU 8016-76B

FLEXIBLER SPANNARM FÜR NASENSPEKULA
FLEXIBLE ARM FOR NASAL SPECULA

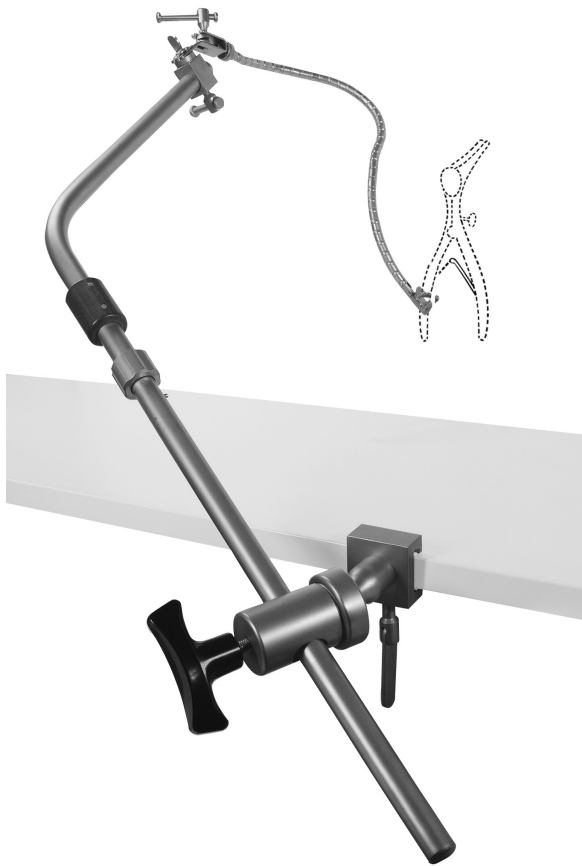

RU 6357-50

Flexibler Spannarm komplett, zur Befestigung an OP-Tischschienen
Flexible arm complete, for attachment to operating table

bestehend aus/consisting of:

RU 6357-10
RU 6357-53
RU 6357-54
RU 6357-55

Für Nasenspekula von Seite 210 und 211
For nasal specula on page 210 and 211

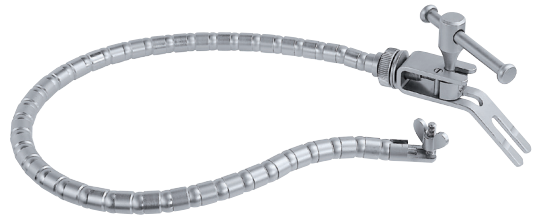

RU 6357-10

flexibler Spannarm allein
Flexible arm only



RU 6357-53

Haltearm, auseinandernehmbar, zur Fixierung im Kugelgelenkkolben RU 6357-54 und zur wahlweisen Aufnahme der Kupplungsköpfe RU 6357-55

Holdering Rod, detachable, for fixation in ball and socket joint RU 6357-54 and to hold a desired coupling head RU 6357-55



RU 6357-54

Kugelgelenkkolben zum Befestigen an der OP-Tischschiene und zur Aufnahme des Haltearms RU 6357-53

Ball and Socket Joint for fixation of holding rod at the operating table RU 6357-53



RU 6357-55

Kupplungskopf, seitlich offen zur Aufnahme von 1 Spannarm RU 6357-10

Coupling head, lateral open, to hold 1 flexible arm RU 6357-10

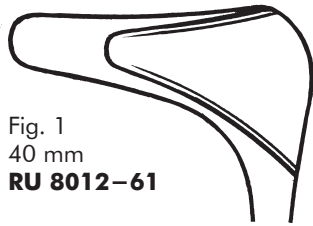

Fig. 1
40 mm
RU 8012-61

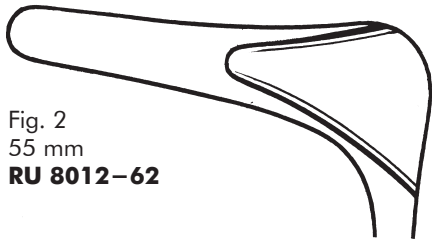

Fig. 2
55 mm
RU 8012-62

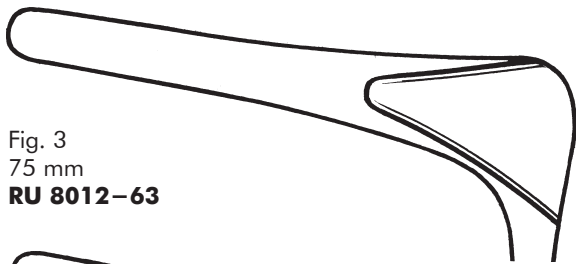

Fig. 3
75 mm
RU 8012-63

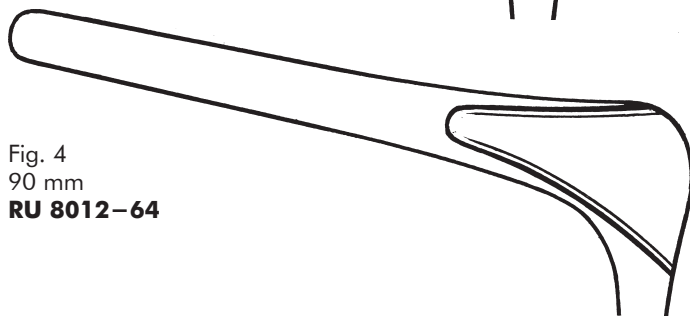

Fig. 4
90 mm
RU 8012-64



zerlegbar
dismantable

Killian

14 cm/5½"
für flexiblen Spannarm
for flexible arm

Zur Verwendung mit dem flexiblen Spannarm
auf Seite 209
For use with the flexible arm on page 209

Nasenspekula
Nasal specula

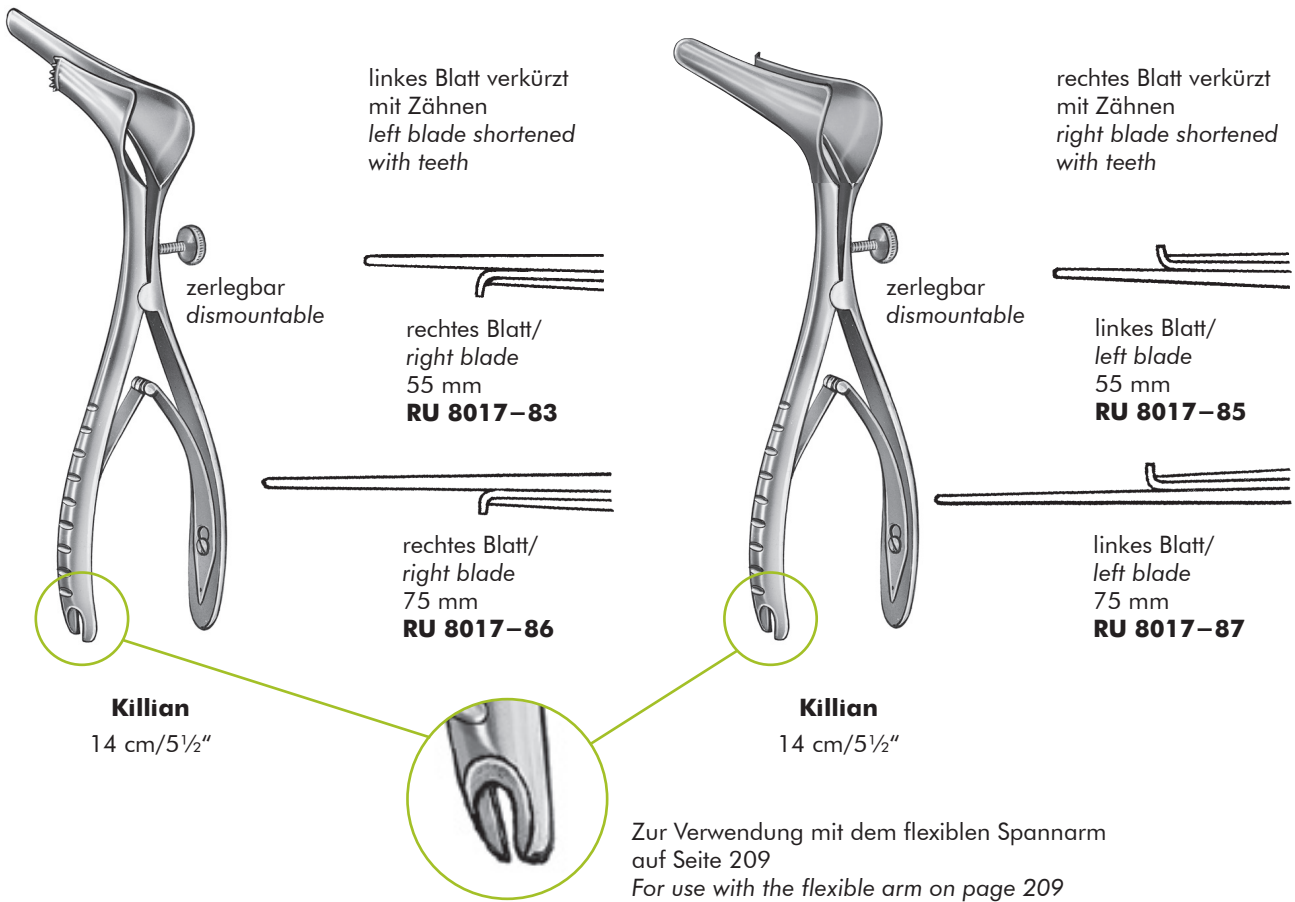

Zur Verwendung mit dem flexiblen Spannarm
auf Seite 209
For use with the flexible arm on page 209



Thudichum
7 cm/2³/₄"

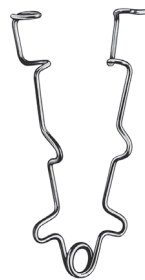

Bowman
7 cm/2³/₄"
RU 9012-07

Blattlänge Length	Standard Standard
12 mm	RU 8018-21
14 mm	RU 8018-22
16 mm	RU 8018-23
18 mm	RU 8018-24
20 mm	RU 8018-25
22 mm	RU 8018-26
24 mm	RU 8018-27
27 mm	RU 8018-28

Polypenschnürer, Schnürerdraht
Nasal snares, snare wire

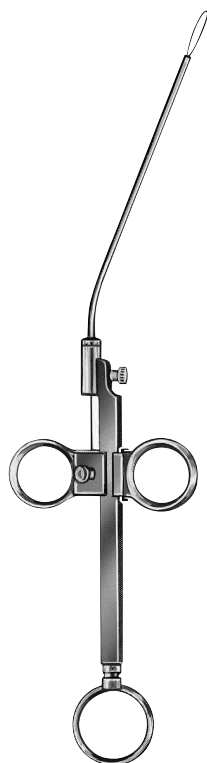

Krause
 26 cm/10¼"
RU 8020-26

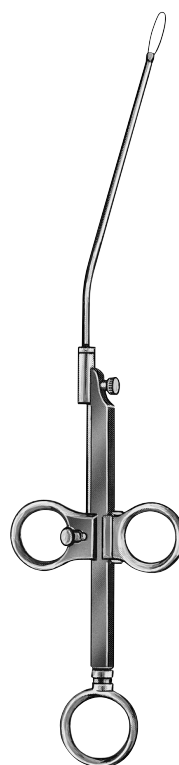

Krause-Voss
 26 cm/10¼"
RU 8021-26

mit 2 Aufsätzen
 für vertikale und horizontale
 Führung des Schnürerdrahts

with 2 snare tubes
 for vertical and horizontal
 snare wire guidance

10 m/33ft.



Ø 0,3 mm **RU 7856-03**
 Ø 0,4 mm **RU 7856-04**



Packung à 12 Stück
 package of 1 dozen each

Ø 0,3 mm **RU 8024-10**

Packung à 100 Stück
 package of 100 pieces

Ø 0,3 mm **RU 8024-10/00**

Nasenpinzetten
Nasal forceps

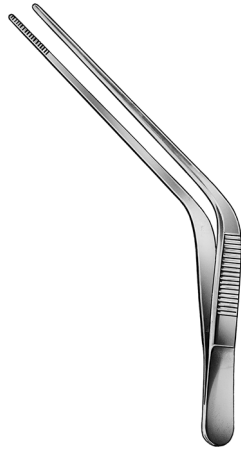

**Troeltsch
(Wilde)**

11 cm/4 ³ / ₈ "	RU 7860-11
12 cm/4 ³ / ₄ "	RU 7860-12
15 cm/6"	RU 7860-15
18 cm/7"	RU 7860-18

2,2 mm



1 mm



**Jansen
(Gruenwald)**

**Jansen
(Fine)**

Jansen

16 cm/6 ¹ / ₄ "	RU 7864-16	RU 7864-26	RU 7865-16
18 cm/7"	RU 7864-18	RU 7864-28	—
20 cm/8"	RU 7864-20	RU 7864-30	RU 7865-20

Nasentamponzangen, Septumzangen
Nasal dressing forceps, septum forceps



Tilley
16 cm/6¼"
RU 8033-16

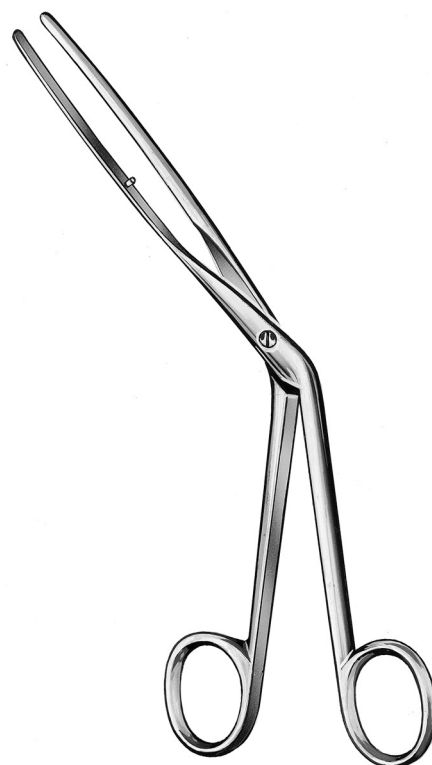

Lubet-Barbon
20 cm/8"
RU 8037-20



Hartmann
16 cm/6¼"
RU 8050-16



Hartmann
20 cm/8"
RU 8050-20

6,5 mm

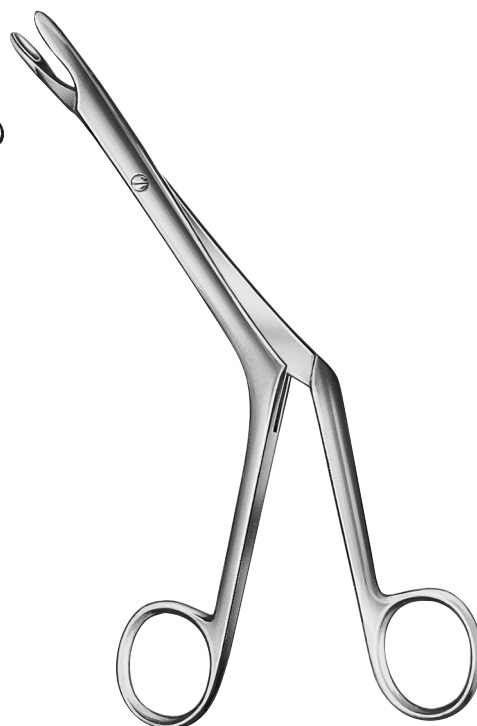

Heymann-Knight
19 cm/7½"
RU 8059-19

Polypenzangen, Septumzangen
Polypus forceps, septum forceps



Craig
17,5 cm/7"
RU 8065-18



RU 8066-01

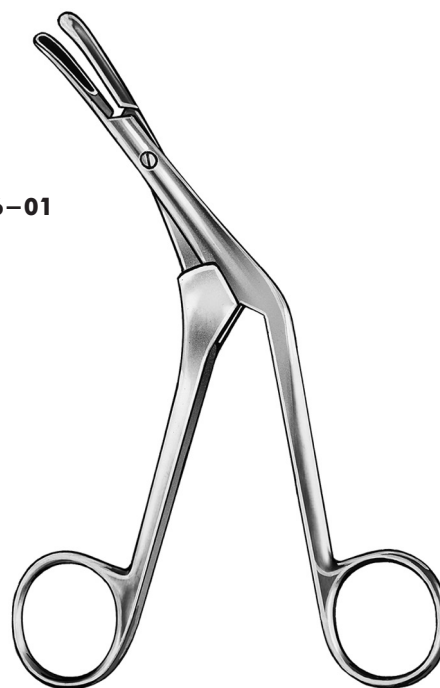

Craig-Domnick
17,5 cm/7"

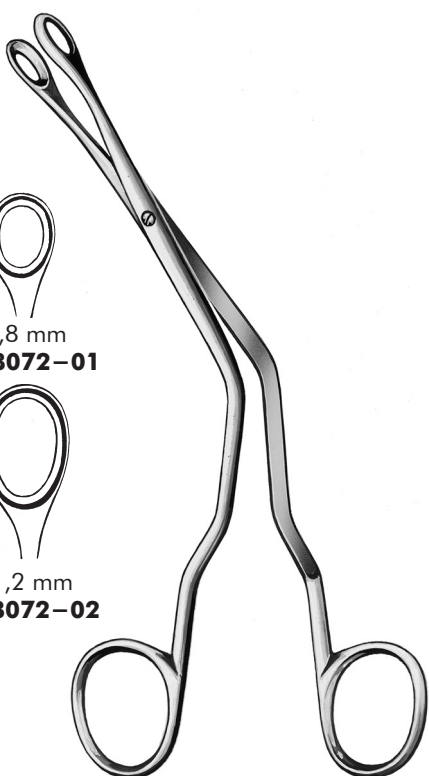

8,8 mm
RU 8072-01

11,2 mm
RU 8072-02

Luc
20 cm/8"

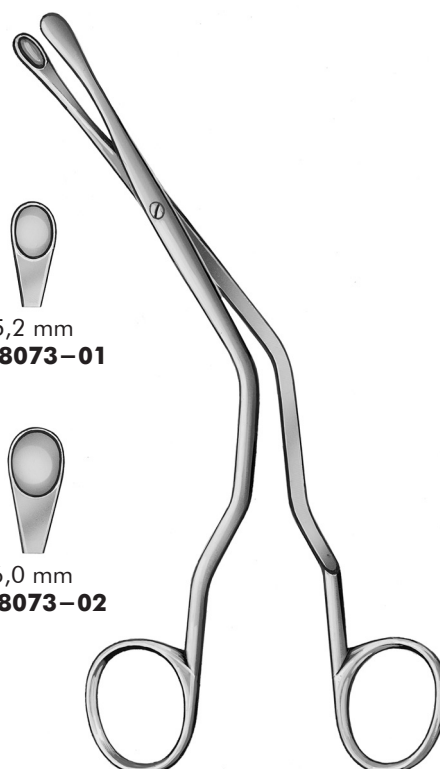

5,2 mm
RU 8073-01

6,0 mm
RU 8073-02

Luc
20 cm/8"

Septumzangen, Löffelzängchen
Septum forceps, cup-shaped forceps



Bruenings
19 cm / 7½"

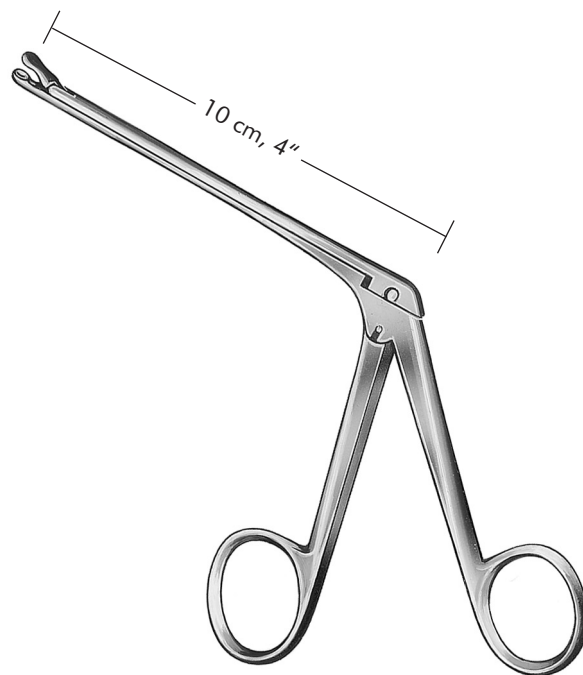

Ø 3 mm
RU 8079-01

Siebbeinzangen
Ethmoidal forceps

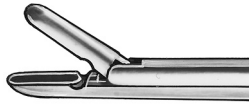

Maul jaw mm	Schaftlänge length of shaft 12 cm/4¾"	Schaftlänge length of shaft 17 cm/6¾"
3 x 10	RU 8080-00	RU 8080-10
2 x 10	RU 8080-02	RU 8080-12
2,5 x 8	RU 8080-03	—



Maul jaw mm	Schaftlänge length of shaft 12 cm/4¾"
3 x 10	RU 8081-00

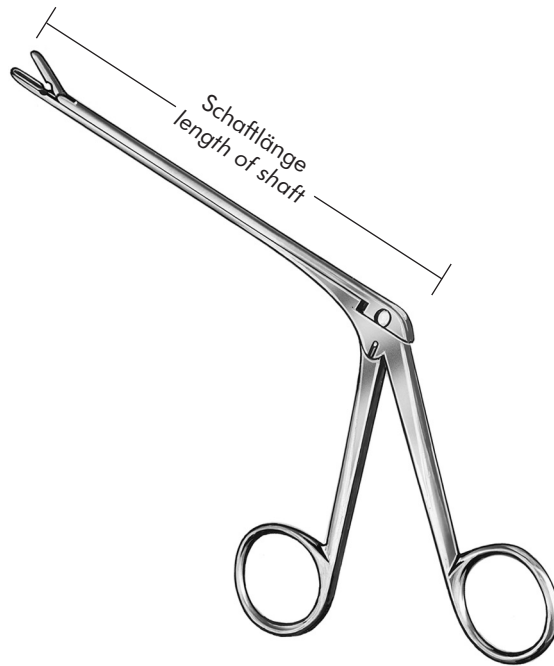

Takahashi



Watson-Williams



3 mm



RU 8083-01

Septumzangen, Biopsie- und Fasszangen
Septum forceps, biopsy and grasping forceps

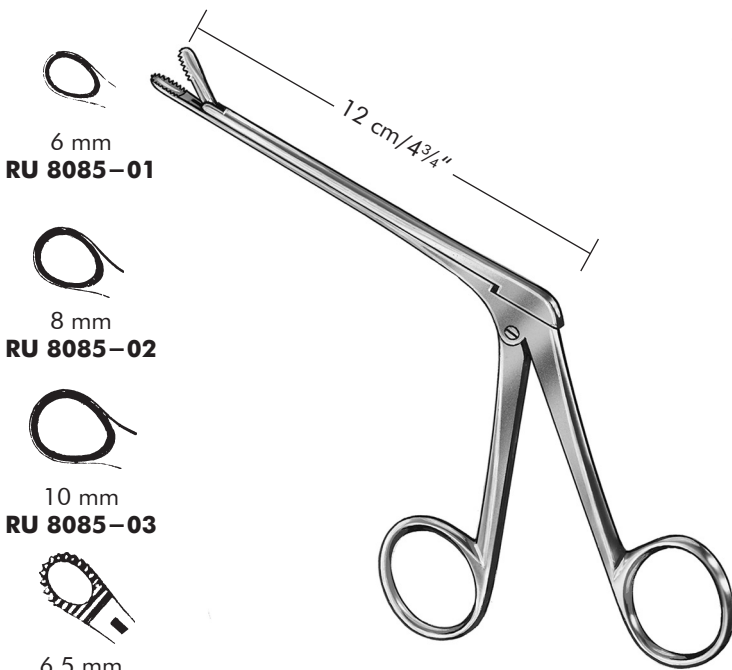

Watson-Williams
 19 cm / 7 1/2"

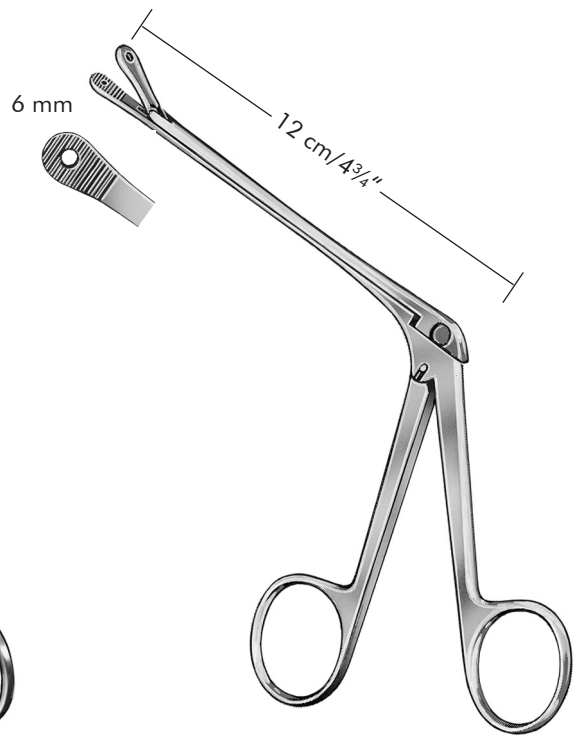

Ferris-Smith
 RU 8087-00

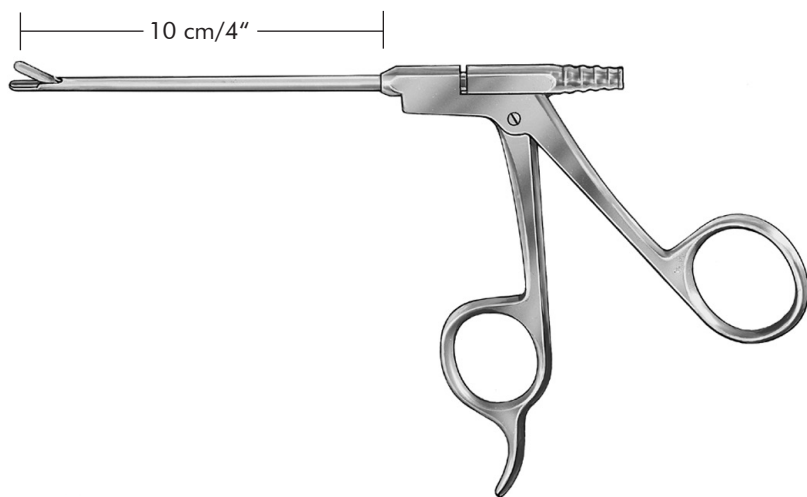

RU 8089-00 gerade, *straight*











RU 8089-01 30° aufgewinkelt, 30° *angled up*

Biopsie- und Fasszange mit Absaugkanal
Biopsy and grasping forceps with suction tube

Siebbeinzangen
Ethmoidal forceps

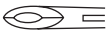

Weil-Blakesley

				
		<i>gerade/straight</i>	<i>45° aufwärts gebogen 45° angled up</i>	<i>90° aufwärts gebogen 90° angled up</i>
2,5 mm		RU 8090-00	RU 8091-00	RU 8092-00
3,0 mm		RU 8090-01	RU 8091-01	RU 8092-01
3,5 mm		RU 8090-02	RU 8091-02	RU 8092-02
4,5 mm		RU 8090-03	RU 8091-03	RU 8092-03
5,0 mm		RU 8090-04	RU 8091-04	RU 8092-04
6,0 mm		RU 8090-05	RU 8091-05	RU 8092-05

Siebbeinzangen
Ethmoidal forceps



Neu entwickelte Blakesley Siebbeinzangen mit verbessertem, modifiziertem, durchschneidendem Maul.
New developed Blakesley ethmoid forceps with improved, modified, intersecting jaw.

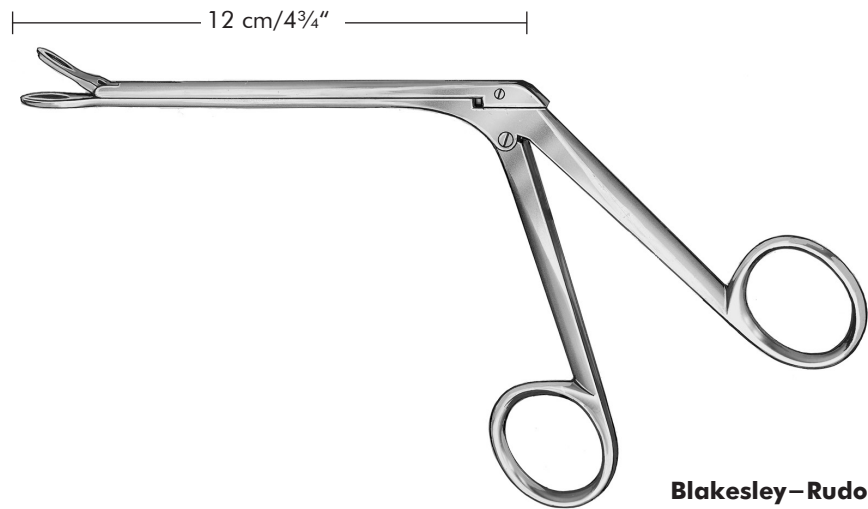

Blakesley–Rudolf





Größe Size	Maul gerade <i>straight jaw</i>	Maul aufgewinkelt <i>jaw angled up</i>	Maul nach links schneidend <i>left cutting</i>	Maul nach rechts schneidend <i>right cutting</i>
Fig. 0/2,5 mm	RU 8090–20	RU 8091–20	—	—
Fig. 2/3,5 mm	RU 8090–22	RU 8091–22	RU 8090–22L	RU 8090–22R
Fig. 4/4,8 mm	RU 8090–24	RU 8091–24	—	—

Conchotome
Nasal cutting forceps



Struycken

-  **RU 8094-00**
1,0 x 19 mm
-  **RU 8094-00/01**
1,2 x 19 mm





Hajek

-  **RU 8095-00**





Myles

-  **RU 8100-01**
2,0 x 10 mm
-  **RU 8100-02**
2,5 x 12 mm
-  **RU 8100-03**
3,0 x 14 mm





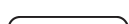

Hajek

-  **RU 8102-01**
3,0 x 12 mm
-  **RU 8102-02**
3,5 x 14 mm
-  **RU 8102-03**
4,0 x 16 mm





Hartmann

-  **RU 8108-05**
5 mm
-  **RU 8108-07**
7 mm
-  **RU 8108-09**
9 mm
-  **RU 8108-11**
11 mm



Hartmann

-  **RU 8108-15**
5 mm
-  **RU 8108-17**
7 mm

Septumzangen, Septumscheren
Septum forceps, septum scissors



Middleton-Jansen
19 cm/7½"
RU 8121-19

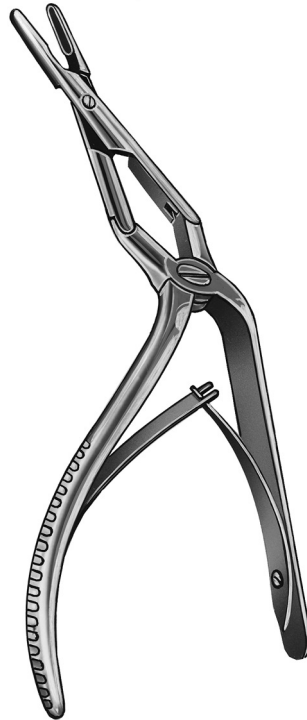

Middleton-Jansen
19 cm/7½"
RU 8122-19

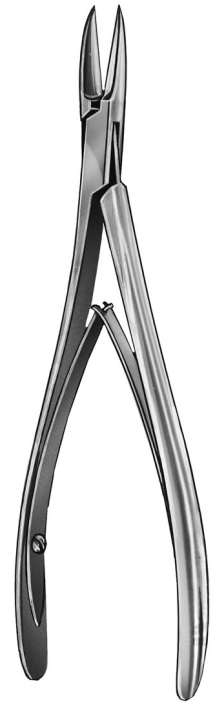



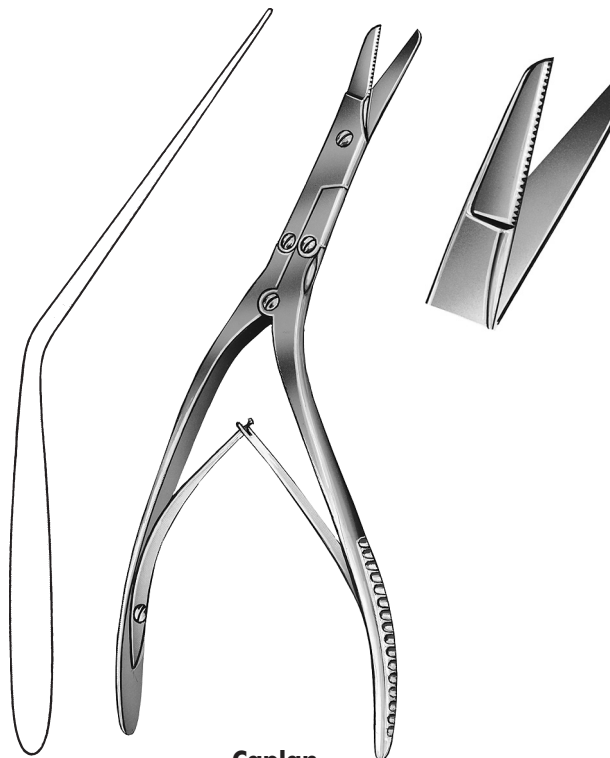

Kazanjian
18 cm/7"
RU 8125-18

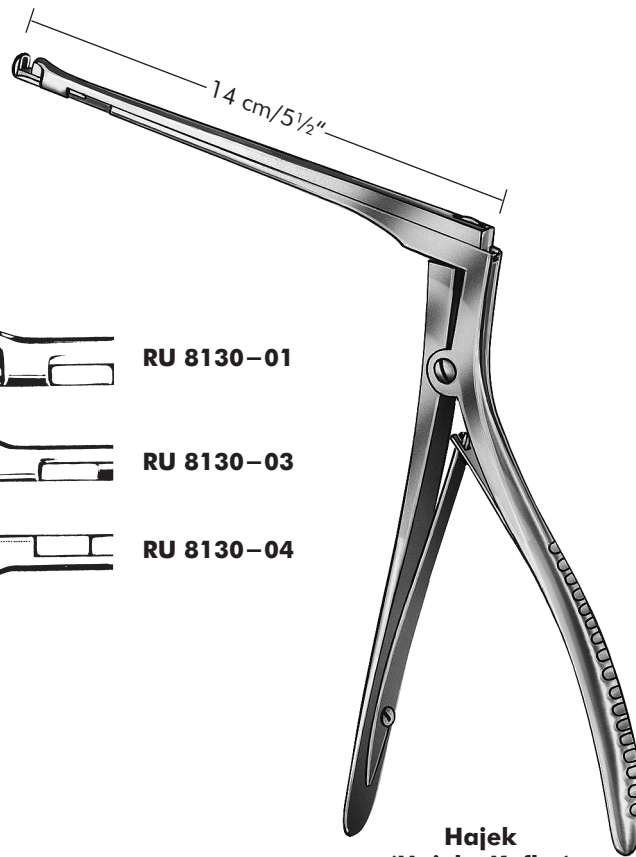

Caplan
20 cm/8"
RU 8126-20

Keilbeinstanzen
Sphenoidal punches

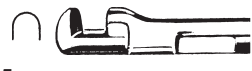



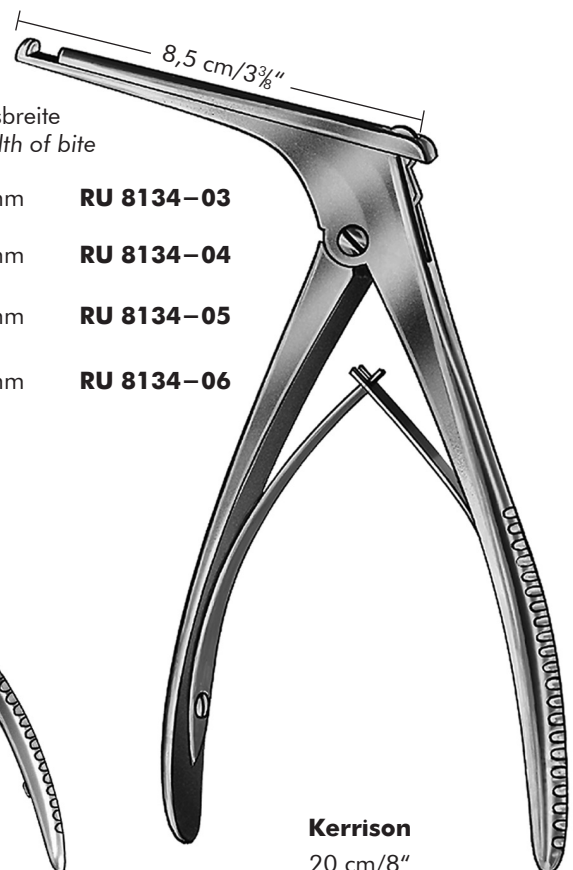

-  **RU 8130-01**
- 4 mm
-  **RU 8130-03**
- 3,5 mm
-  **RU 8130-04**
- 3,5 mm

Hajek
(Hajek-Kofler)



Bissbreite
 Width of bite

-  3 mm **RU 8134-03**
-  4 mm **RU 8134-04**
-  5 mm **RU 8134-05**
-  6 mm **RU 8134-06**

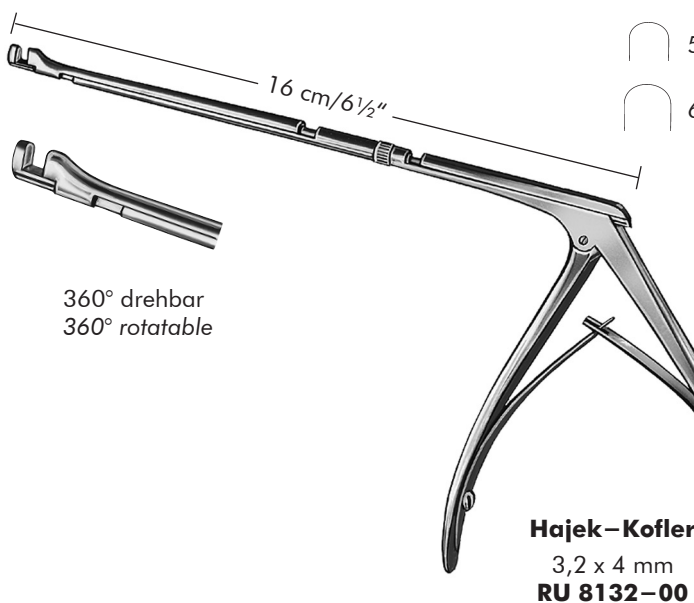

360° drehbar
 360° rotatable

Hajek-Kofler
 3,2 x 4 mm
RU 8132-00

Kerrison
 20 cm/8"



Joseph
15 cm/6"
spitz/sharp
gerade/straight
RU 8140-01



Converse
15 cm/6"
RU 8144-15



Joseph
14 cm/5½"
RU 8145-15



Cottle
15 cm/6"
RU 8146-15



Cottle
14 cm/5½"
RU 8147-14



Freer
16 cm/6¼"
RU 8149-02



Masing
13,5 cm/5¼"
RU 8155-13



Masing
14 cm/5½"
RU 8156-14



Freer
19 cm/7½"
RU 8171-19



Ballenger
20 cm/8"

RU 8200-03
RU 8200-04



3 mm
4 mm
5 mm

RU 8201-03
RU 8201-04
RU 8201-05



Ballenger
20 cm/8"

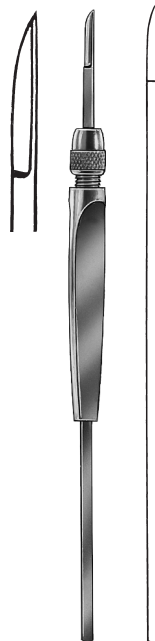

Bruenings
16,5 cm/6½"
RU 8202-16

Septum-Elevatorien, Raspatorien
Septum elevators, Raspatories



3 mm **RU-8203-03**
 4 mm **RU-8203-04**
 5 mm **RU-8203-05**

M Kenty
 15 cm/6"



Halle
 18,5 cm/7¼"
 stumpf/blunt
RU 8204-16

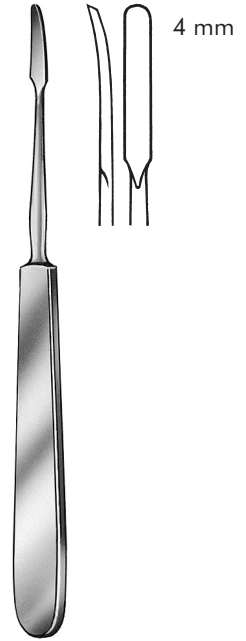

Joseph
 16,5 cm/6½"
RU 8206-16



Cottle
 19,5 cm/7½"
RU 8210-19



Freer-Joseph
 20 cm/7¾"
RU 8211-20

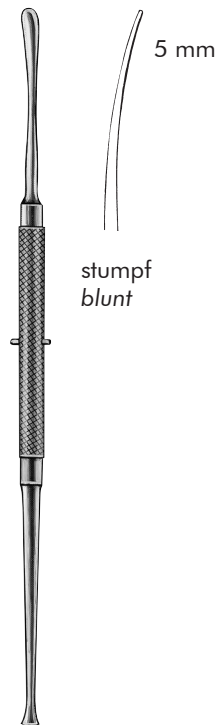

Freer
 19 cm/7½"
RU 8212-19

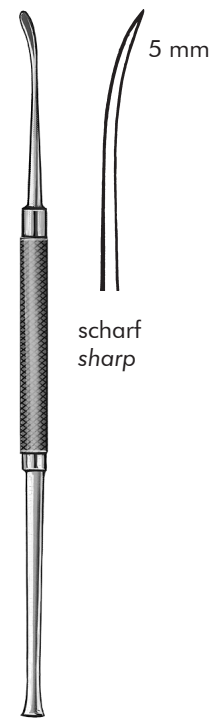

Freer
 19 cm/7½"
RU 8213-19

Septum-Elevatoren
Septum elevators

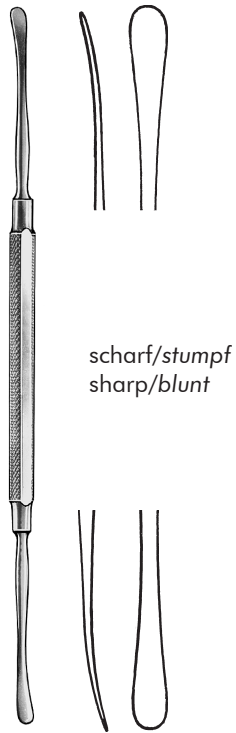

scharf/stumpf
 sharp/blunt

Freer-USA Mod.
 20 cm/8³/₄"
RU 8214-20

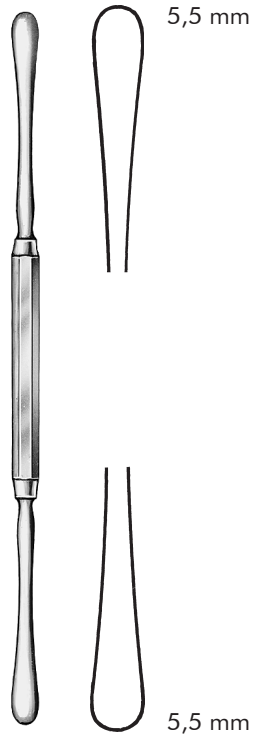

5,5 mm

5,5 mm

Hajek-Ballenger
 19 cm/7¹/₂"
RU 8215-20

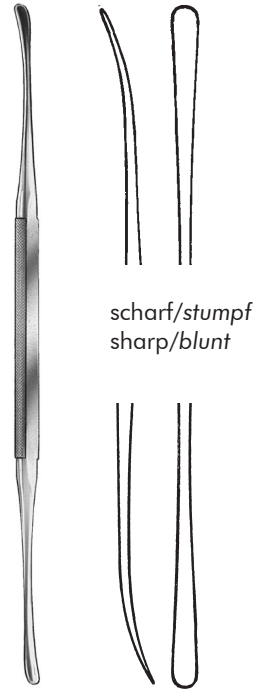

scharf/stumpf
 sharp/blunt

Freer
 18 cm/7"
RU 8216-18

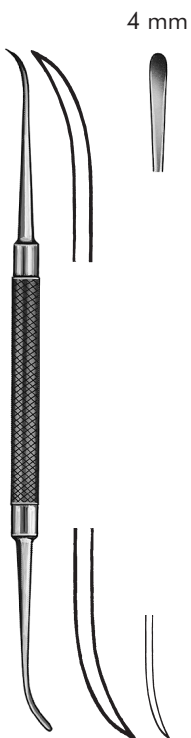

4 mm

Freer-Yasargil
 18,5 cm/7¹/₄"
 scharf/sharp
RU 8217-18

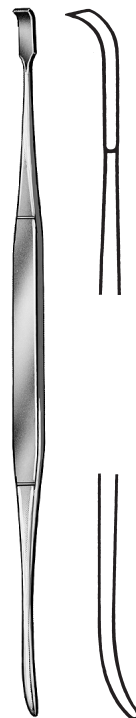

Howarth
 21,5 cm/8¹/₂"
RU 8218-21



M Kenty
 22 cm/8³/₄"
RU 8219-22

Septum-Elevatorien
Septum elevators

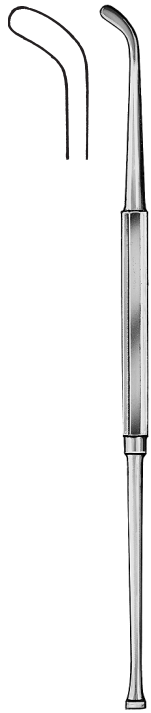

Freer
18,5 cm/7¼"
RU 8220-19



Killian
18,5 cm/7¼" **RU 8222-18**
22 cm/8¾" **RU 8226-22**

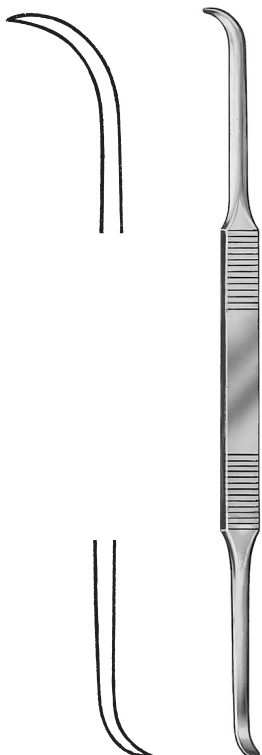

Cottle
23 cm/9"
RU 8224-23



Killian
18,5 cm/7¼"
scharf/stumpf, sharp/blunt
RU 8226-18

Raspatorien, Elevatorien
Raspatories, elevators



Pierce
 21 cm/8¼"
RU 8228-21

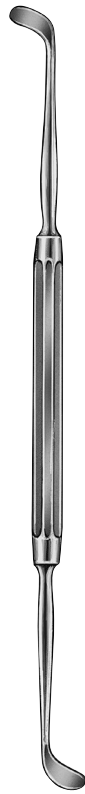

Pennington
 21 cm/8¼"
RU 8230-21

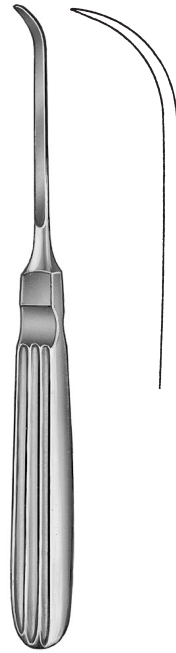

17 cm/6¾"

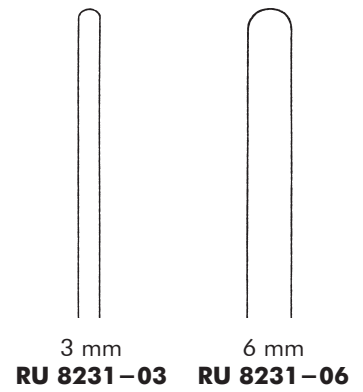

3 mm
RU 8231-03

6 mm
RU 8231-06

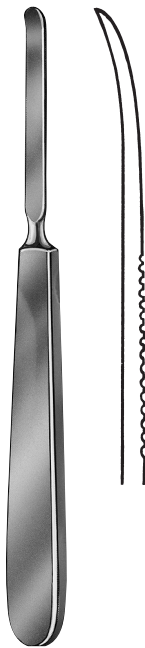

17 cm/6¾"
 6 mm 8 mm
RU 5394-06 RU 5394-08



M Donald
 19 cm/7½"
RU 5434-19

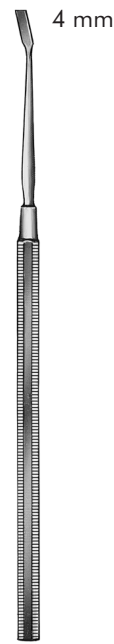

4 mm
 16,5 cm/6½"
RU 8231-16

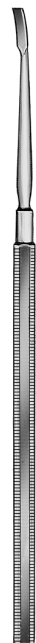

Freer
 16,5 cm/6½"
RU 8232-18



Cottle
20 cm/8"
RU 8237-20



**Joseph (Cottle)
Masing**
22 cm/8¾"
RU 8238-22



Masing
20,5 cm/8¾" 22,5 cm/8¾"
RU 8239-20 RU 8239-22



Joseph
18 cm/7"
RU 8240-16
Periost-Elevator
Periosteum elevator

Osteotome, Flach- und Hohlmeißel
Osteotomes, chisels and gouges



18,5 cm/7¼"

Nasenseptum-Osteotome
 Osteotomes for septum

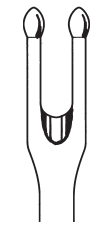

4 mm
RU 8243-04



6 mm
RU 8243-06



8 mm
RU 8243-08



Freer
 16 cm/6¼"
RU 8244-16

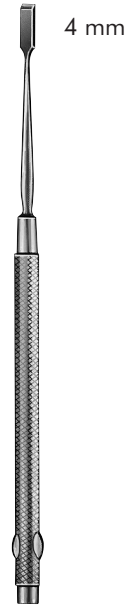

Freer
 16 cm/6¼"
RU 8245-16



Freer
 15 cm/6"
RU 8246-15

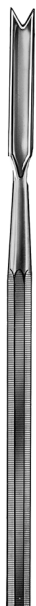

Ballenger
 16 cm/6¼"
 2 mm **RU 8247-02**
 4 mm **RU 8247-04**
 6 mm **RU 8247-06**

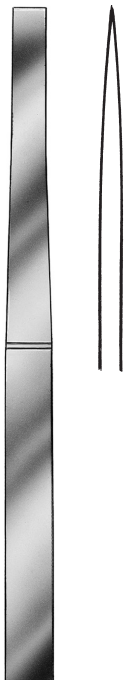

Converse
 18 cm/7"
 2 mm **RU 8248-02**
 3 mm **RU 8248-03**
 4 mm **RU 8248-04**
 5 mm **RU 8248-05**
 6 mm **RU 8248-06**
 7 mm **RU 8248-07**
 8 mm **RU 8248-08**
 9 mm **RU 8248-09**
 10 mm **RU 8248-10**

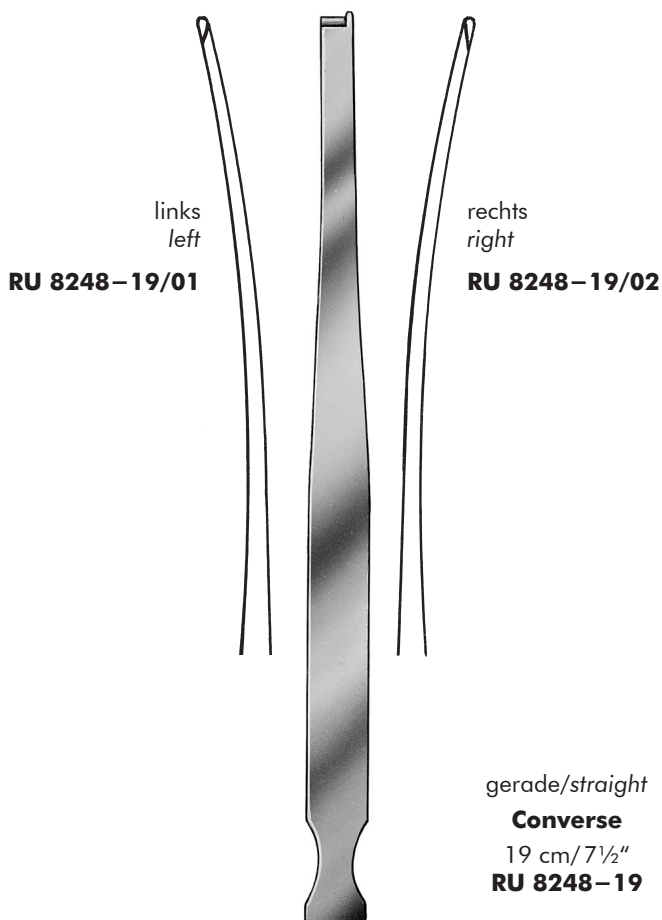

Sheehan (Rubin)

16 cm/6¼"

- 2 mm **RU 8249-02**
- 3 mm **RU 8249-03**
- 4 mm **RU 8249-04**
- 6 mm **RU 8249-06**
- 8 mm **RU 8249-08**
- 10 mm **RU 8249-10**
- 15 mm **RU 8249-15**



Mini-Lambotte

12,5 cm/5"

- 2 mm **RU 5332-02**
- 3 mm **RU 5332-03**
- 4 mm **RU 5332-04**
- 6 mm **RU 5332-06**
- 8 mm **RU 5332-08**
- 10 mm **RU 5332-10**
- 12 mm **RU 5332-12**
- 15 mm **RU 5332-15**



12,5 cm/5"
gebogen/curved

- 2 mm **RU 5332-22**
- 4 mm **RU 5332-24**
- 6 mm **RU 5332-26**
- 8 mm **RU 5332-28**
- 10 mm **RU 5332-30**
- 12 mm **RU 5332-32**

Flach- und Hohlmeißel, Osteotome
Chisels and gouges, osteotomes



Killian
 16 cm/6¼"
RU 8250-16

Killian-Claus
 16 cm/6¼"
RU 8252-16



Cottle
 18 cm/7"

- 2 mm **RU 8253-02**
- 4 mm **RU 8253-04**
- 6 mm **RU 8253-06**
- 7 mm **RU 8253-07**
- 9 mm **RU 8253-09**
- 12 mm **RU 8253-12**

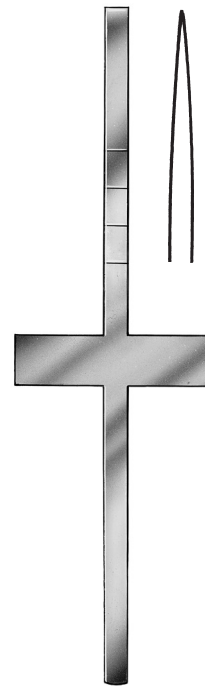

Cottle
 18 cm/7"

- 4 mm **RU 8253-24**
- 6 mm **RU 8253-26**
- 7 mm **RU 8253-27**
- 9 mm **RU 8253-29**
- 12 mm **RU 8253-32**

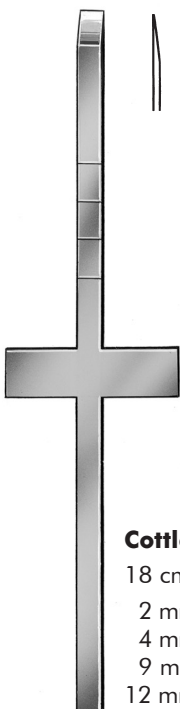

Cottle
 18 cm/7"
 2 mm **RU 8254-02**
 4 mm **RU 8254-04**
 9 mm **RU 8254-09**
 12 mm **RU 8254-12**

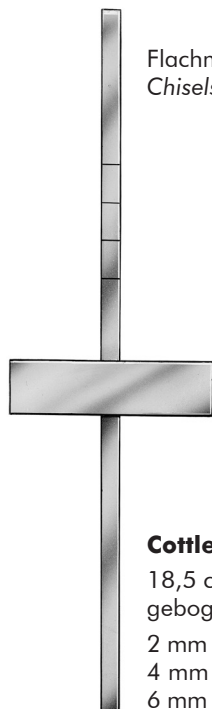

Flachmeißel
 Chisels

Cottle
 18,5 cm/7¼"
 gebogen/curved
 2 mm **RU 8254-52**
 4 mm **RU 8254-54**
 6 mm **RU 8254-56**



Cottle
 18 cm/7"
RU 8255-16/01



16 mm

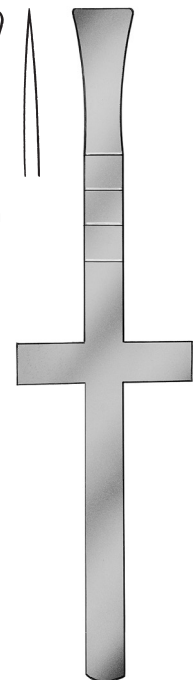

Cottle
 18 cm/7"
RU 8255-16/02

Septum-Meissel, Osteotome
Septum chisels, osteotomes



18 cm/7"
 8 mm
RU 8256-58



4 mm
RU 8258-04
 6 mm
RU 8258-06
 7 mm
RU 8258-07
 9 mm
RU 8258-09
 12 mm
RU 8258-12
Cottle
 18 cm/7"



6 mm
Cottle
 18 cm/7"
 gebogen/curved
RU 8259-06



5 mm
RU 8260-05
 8 mm
RU 8260-08
Fomon
 17 cm/6¾"



5 mm

Cottle
 18,5 cm/7¼"
RU 8260-25



Walter
 18 cm/7"
 3 mm
RU 8261-03
 4,5 mm
RU 8261-04



Walter
 19 cm/7½"
 2 mm
RU 8261-22
 3 mm
RU 8261-23
 4 mm
RU 8261-24
 7 mm
RU 8261-27

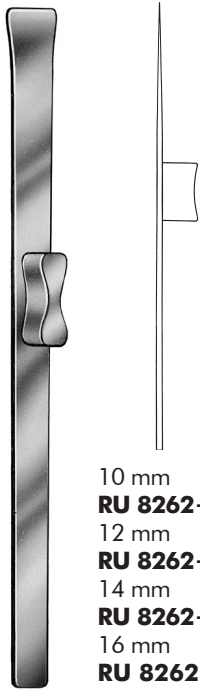

10 mm
RU 8262-10
12 mm
RU 8262-12
14 mm
RU 8262-14
16 mm
RU 8262-16

Rubin
18 cm/7"

RU 8263-01



**(Silver)
Masing**
17,5 cm/6⁷/₈"
RU 8263-02



RU 8263-03



links
left
RU 8263-21
rechts
right
RU 8263-22

Neivert
20,5 cm/8¹/₄"
gerade/straight
RU 8263-20



Guastella-Ey
18 cm/7"
RU 8263-31 **RU 8263-32**



3 mm
RU 8263-40



3 mm
Würzburger Modell
18 cm/7"
links/left
RU 8263-41



rechts/right
RU 8263-42

Osteotome, Hämmer
Osteotomes, mallets



Cinelli
 16 cm/6¼"

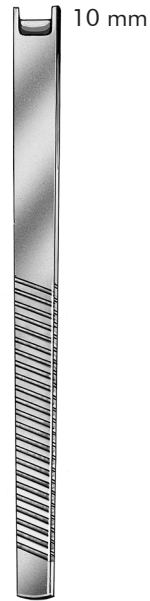
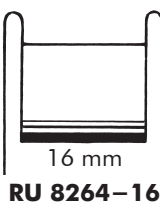
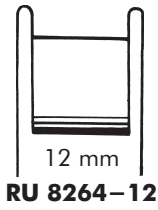
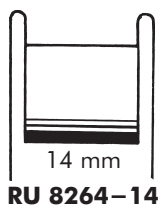
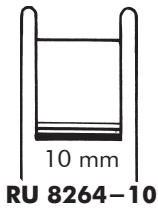

Masing
 17,5 cm/6⅞"
RU 8265-00



18 cm/7"
 Ø 25 mm/140 g
RU 5799-18

Ersatzbackenpaar
 Pair of spare jaws
RU 5799-51

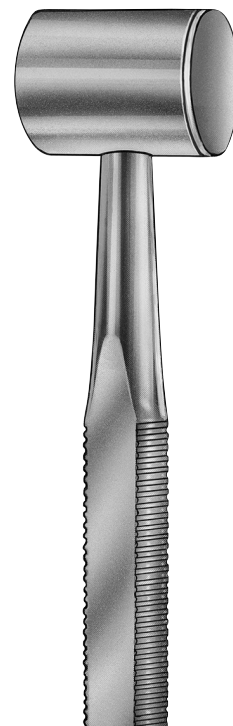

Cottle
 19 cm/7½"
 Ø 30 mm/350 g
 1 Seite flach/1 Seite konvex
 1 side flat/1 side convex
RU 5809-19



Joseph
17 cm/6³/₄"



RU 8267-00



RU 8267-01



RU 8267-02

Nasenraspeln
Nasal rasps

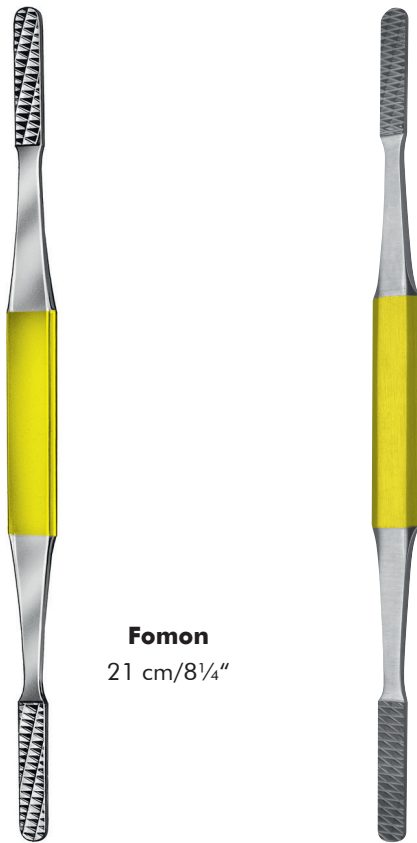
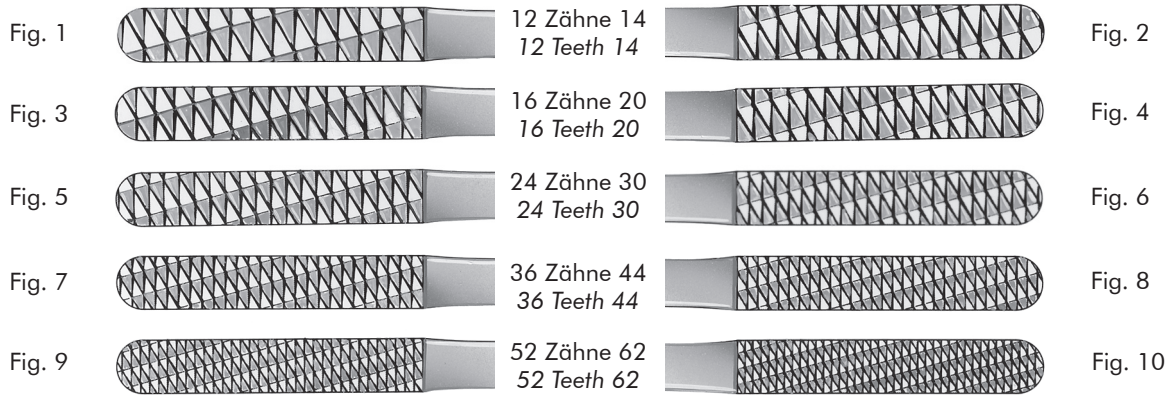

Fomon
21 cm/8 1/4"



Parkes
21 cm/8 1/4"

Maltz
17 cm/6 3/4"



	Zähne Teeth	feines Modell delicate Pattern	
Fig. 1/2	12/14	RU 8268-01/12	RU 8268-02/12
Fig. 3/4	16/20	RU 8268-01/34	RU 8268-02/34
Fig. 5/6	24/30	RU 8268-01/56	RU 8268-02/56
Fig. 7/8	36/44	RU 8268-01/78	RU 8268-02/78
Fig. 9/10	52/62	RU 8268-01/99	RU 8268-02/99

	Parkes 21 cm/8 1/4"	Maltz 17 cm/6 3/4"
Fig. 1	RU 8268-05/01	—
Fig. 3	—	RU 8268-07/03
Fig. 4	—	RU 8268-07/04
Fig. 5	RU 8268-05/05	RU 8268-07/05
Fig. 6	—	RU 8268-07/06
Fig. 7	—	RU 8268-07/07
Fig. 8	—	RU 8268-07/08
Fig. 10	—	RU 8268-07/10

Nasenraspeln
Nasal rasps

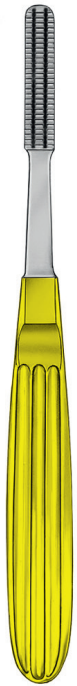

RU 8268-10/01

RU 8268-10/02



Maltz

17,5 cm/6¾"



12 x 5 mm

12 x 5 mm

RU 8268-12/01

RU 8268-12/02

7 x 15 mm

7 x 15 mm



Miller

19 cm/7½"



RU 8272-02

RU 8272-03

plan
plane

RU 8272-04

RU 8272-05

konvex
convex

RU 8272-06

konkav
concave

◀ **Diamantaufgabe**
diamond jaw ▶



Fomon

21 cm/8¼"

RU 8276-21

Nasenraspeln
Nasal rasps

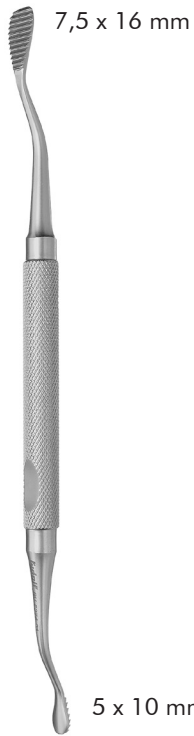

Miller
18 cm/7"
RU 5374-01

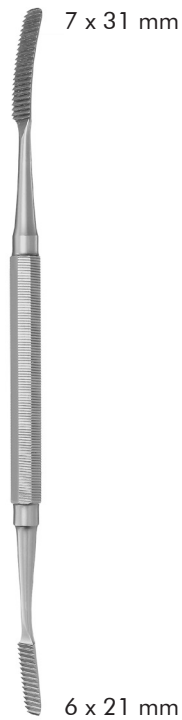

Miller
18 cm/7"
RU 5374-02



Miller
18 cm/7"
RU 5374-03

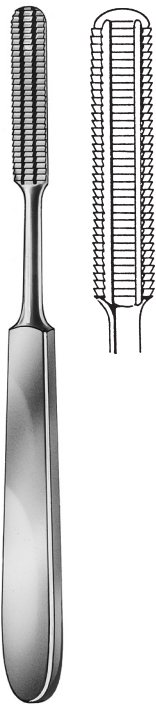

Maltz
18 cm/7"
RU 8270-18



Joseph
16 cm/6¼"

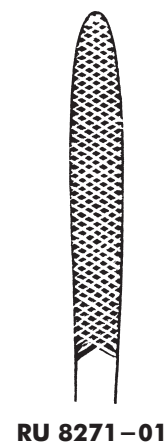

Nasenraspeln
Nasal rasps



fein
fine

RU 8273-01



grob
coarse

RU 8273-02

Lewis
18 cm/7"



Cottle
21 cm/8¼"
RU 8274-21



RU 8275-01



RU 8275-02

Aufricht
22 cm/8¾"

Nasenraspeln, Knochen-Knorpelquetsche, Metalltablett
Nasal rasps, bone crusher, preparation tray

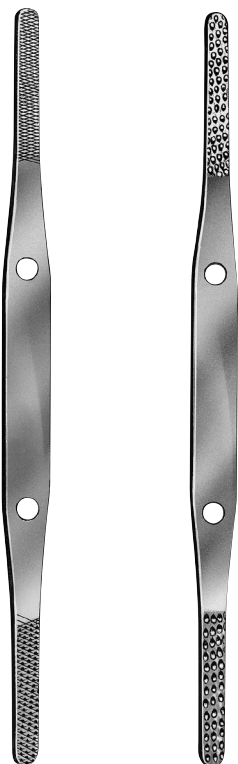

Fomon
 21 cm/8¼"
RU 8276-01 RU 8276-02



**Kleinert-Kutz
 (Fomon)**
 21 cm/9"
RU 8276-50
 doppelendig, vierseitig
 mit je 2 Seiten fein (flach) und grob (konvex)
double-ended, 4-sided
 each of 2 sides fine (flat) and coarse (convex)

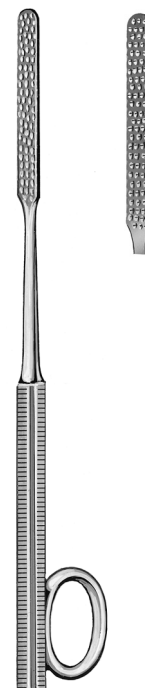

Gallaher
 18 cm/7"
RU 8277-01

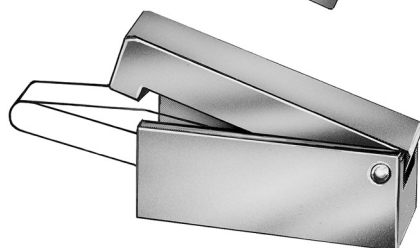

RU 8278-00
 Knochen-Knorpelquetsche
Bone crusher



92 x 54 mm
RU 7908-90
 Präpariertablett aus Metall
Preparation tray of metal



85 x 55 x 10 mm
RU 8278-10
 Knorpelschneidblock aus PPSU schwarz
Cartilage cutting block of PPSU black



Fig. 1

Gillies
18 cm/7"
RU 6296-01



Fig. 2

Gillies
18 cm/7"
RU 6296-02

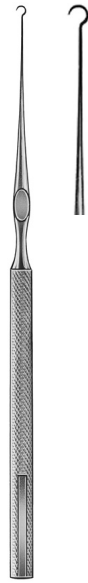

Kilner
15 cm/6"
RU 6297-15



scharf
sharp

Frazier
13 cm/5"
RU 6392-13
18 cm/7"
RU 6392-18

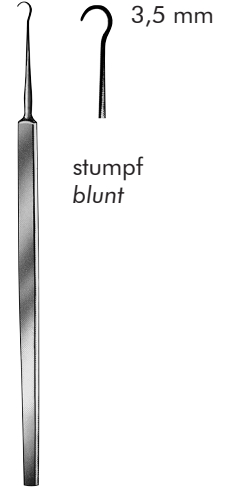

stumpf
blunt

Frazier
13 cm/5"
RU 6393-13
18 cm/7"
RU 6393-18

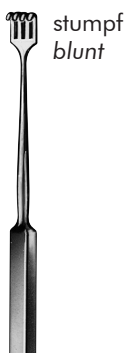

stumpf
blunt

Knapp
13 cm/5"
RU 9405-13



scharf
sharp

Rollet
13 cm/5"
RU 9406-13

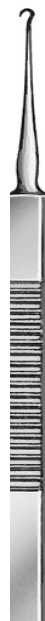

16 cm/6¼"



Graefe
RU 4430-51



stumpf
blunt

Graefe
RU 4430-52

Haken, Fadengabel
Hooks, suture pusher and knot tier



18,5 cm/7¼"
90° abgewinkelt
90° angled
RU 8822-06

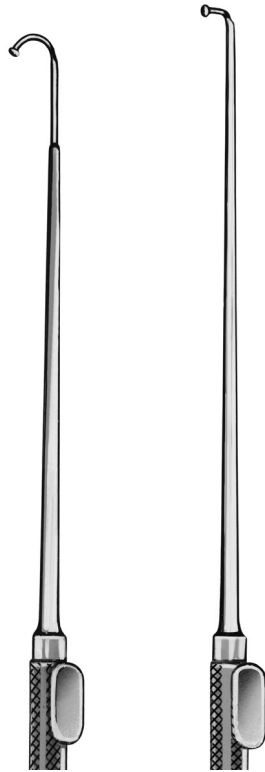

Yasargil **Yasargil**
18,5 cm/7¼" 18,5 cm/7¼"
RU 8826-02 **RU 8826-03**
Fadenführer geknöpft
Ligature guides, probe pointed



18,5 cm/7¼"
RU 8835-13
Fadengabel
*Suture pusher
and knot tier*

Haken
Hooks



Cottle
16 cm/6¼"
RU 8281-16

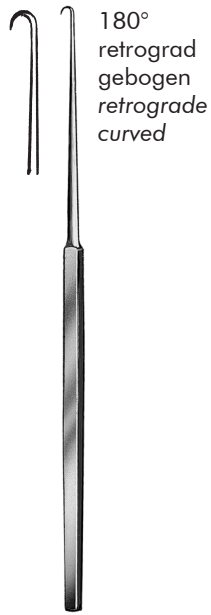

Cottle
16 cm/6¼"
RU 8282-03



14,5 cm/5½"
RU 8283-02



16,5 cm/6"
RU 8283-04



Cottle
15 cm/6"
RU 8284-01



Fomon
17 cm/6³/₄"
RU 8287-17



Freer
15 cm/6"
RU 8290-15



Joseph
15 cm/6"
RU 8280-15



Joseph
16 cm/6¹/₄"



2 mm
RU 8292-02



5 mm
RU 8292-05



7 mm
RU 8292-07



10 mm
RU 8292-10

Haken
Hooks



Fomon
16 cm/6¼"
RU 8294-16

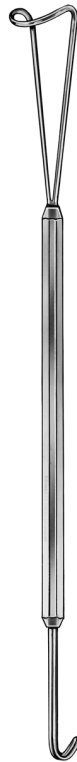

Neivert (Masing)
20 cm/8"
RU 8298-20

10 mm



Neivert
19,5 cm/7¾"
RU 8299-19



Cottle-Neivert
20 cm/8"
RU 8299-20



Cottle
14,5 cm/5¾"
RU 8300-14

10 x 12 mm

13 x 24 mm

6 x 12 mm



Cottle
14,5 cm/5¾"
RU 8301-01



Cottle
14,5 cm/5¾"
RU 8301-02



Cottle
15 cm/6"
RU 8302-15



Cottle
16 cm/6¼"
RU 8302-30



Masing
14 cm/5½"
RU 8302-31



Kilner
8 cm/3⅛"



scharf/sharp
10 mm **RU 8303-08**
13 mm **RU 8303-09**



Cottle
5,5 cm/2¼"
RU 8303-30



Converse
12 cm/4¾"
RU 8304-12

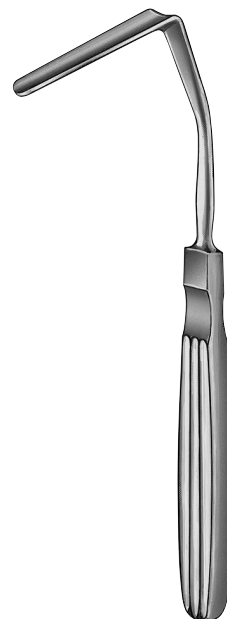

Aufrecht
16 cm/6¼"
8 x 45 mm **RU 8310-16**
8 x 60 mm **RU 8310-60**



Cottle
10 cm/4"
RU 8312-10

stumpf/blunt
10 mm **RU 8303-18**

Haken, Nasenfrakturaufrichter
Hooks, septum elevators

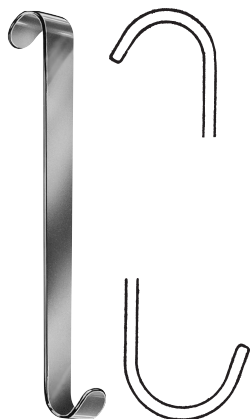

Luer
 11 cm/4½"
RU 4479-11

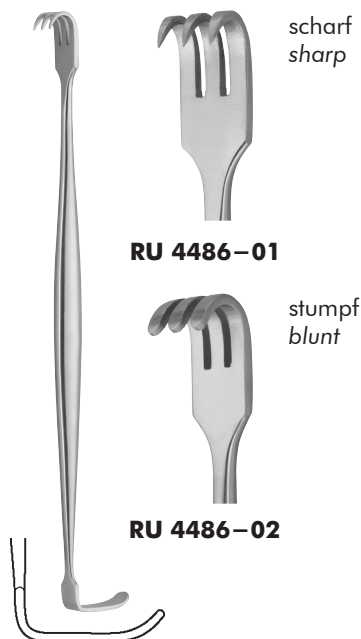

Senn-Miller
 16 cm/6¼"

scharf
sharp

RU 4486-01

stumpf
blunt

RU 4486-02

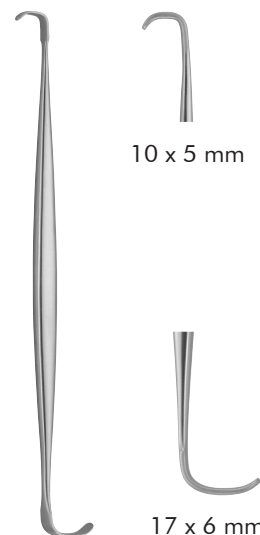

Ragnell-Davis
 15 cm/6"
RU 4488-14

10 x 5 mm

17 x 6 mm

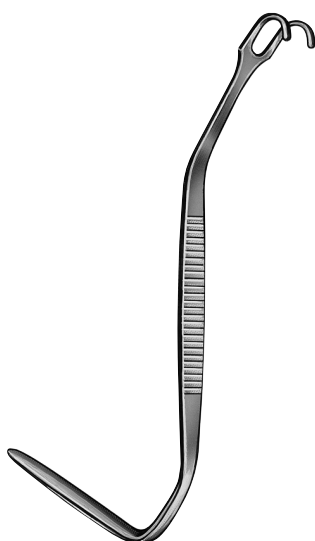

Walter
 13 cm/5"
RU 8316-12



Boies
 18 cm/7"
RU 8326-01



Goldmann
 20 cm/8"
RU 8326-02

Septumrichtzangen
Septum straightening forceps



Walsham
23 cm/9"



RU 8328-01
rechts und links
verwendbar
*applicable for
left and right*



RU 8328-02
rechts
right



RU 8328-03
links
left

Septumrichtzangen
Septum straightening forceps



Asch
23 cm/9"
abgewinkelt/angular
RU 8330-23



Kressner
20 cm/8"
3 mm **RU 8331-20**
4 mm **RU 8331-21**

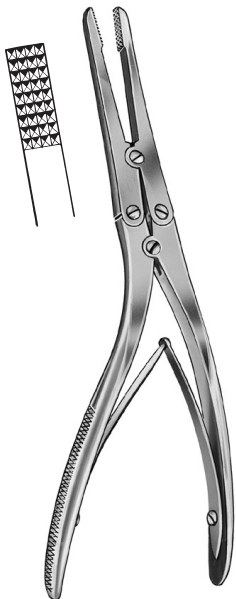

Rubin
20 cm/8"
RU 8333-20



RU 8333-50
Schutzhülle alleine, für RU 8333-20
Protecting cap only, for RU 8333-20



Präparierscheren, Tonsillenscheren	<i>Dissecting Scissors, Tonsil Scissors</i>	255
Wundhaken	<i>Retractors</i>	256
Ringmesser	<i>Adenoid Curettes</i>	256 — 257
Mundsperrerr, Zungenspatel	<i>Mouth Gags, Tongue Blades</i>	258 — 263
Bruststütze	<i>Chest Support</i>	263
Mundsperrerr, Wangenhalter	<i>Mouth Gags, Cheek Holder</i>	264 — 265
Mund- und Zungenspatel	<i>Mouth and Tongue Depressors</i>	266 — 267
Zungenspatel, Zungenzangen	<i>Tongue depressors, Tongue Holding Forceps</i>	267
Tamponstopfer, Tonsillennadeln, Ligaturinstrumente	<i>Gauze Packers, Tonsil Needles, Ligature Instruments</i>	268
Tonsillennmesser, Elevatorien	<i>Tonsil Knives, Elevators</i>	269 — 270
Tonsillennfasszangen, Tonsillennklemmen	<i>Tonsil Grasping Forceps, Tonsil Hemostatic Forceps</i>	271 — 272
Tonsillennschnürer	<i>Tonsil Snares</i>	273
Tonsillennotome	<i>Tonsillectomes</i>	274
Tonsillenn-Conchotome	<i>Tonsil Punches</i>	275

Präparierscheren, Tonsillenscheren
Dissecting scissors, tonsil scissors

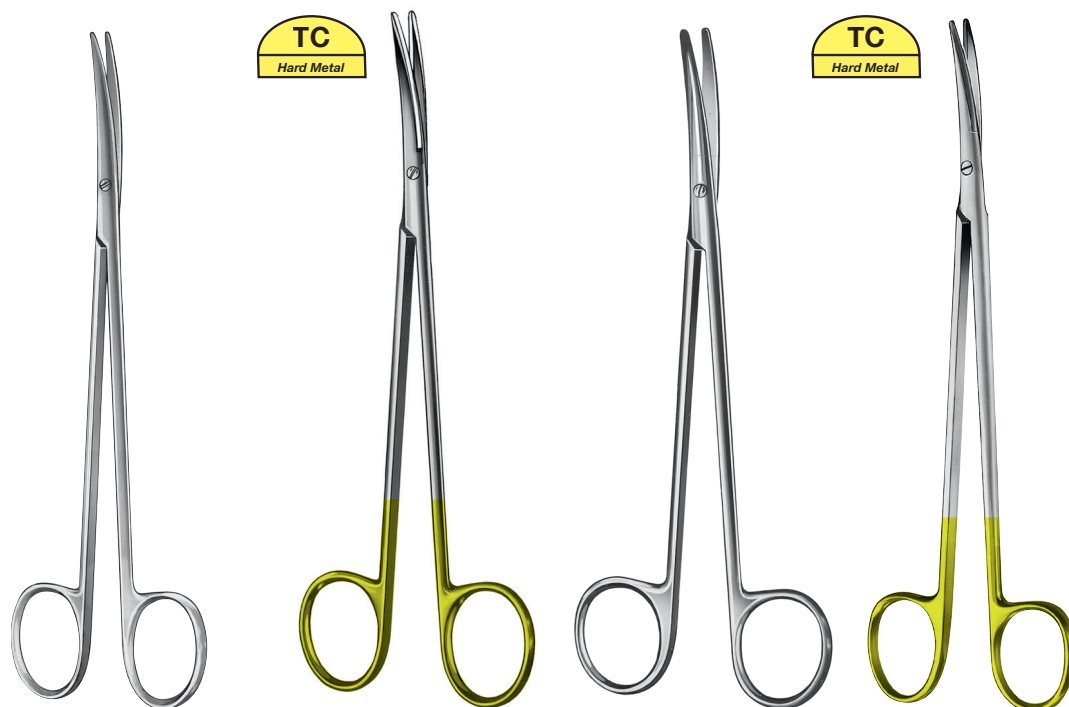

	Metzenbaum-Fino	Metzenbaum-Fino	Metzenbaum	Metzenbaum
18 cm/7"	RU 1330-18	RU 1336-18	RU 1331-18	RU 1334-18
20 cm/8"	RU 1330-20	RU 1336-20	RU 1331-20	—



Böttcher
 18 cm/7"
RU 1810-18



Good
 19 cm/7½"
RU 1845-19



18 x 22 mm



17 x 16 mm
Baby-Roux
 13 cm/5"
RU 4492-13



Middeldorpf



14 x 17 mm
 21,5 cm/8½"
RU 4551-01



20 x 22 mm
 22 cm/8¾"
RU 4551-02



26 x 30 mm
 23,5 cm/9¼"
RU 4551-03

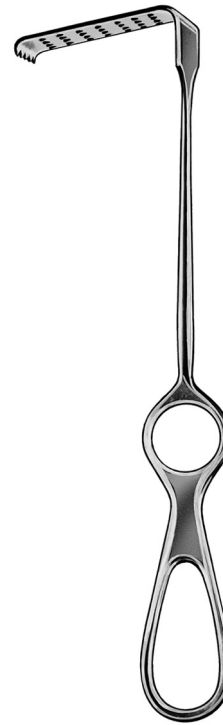

Brünings-Brunk
 22,5 cm/8¾"
RU 8363-19
 Kieferhöhlenhaken
 Antrum retractor

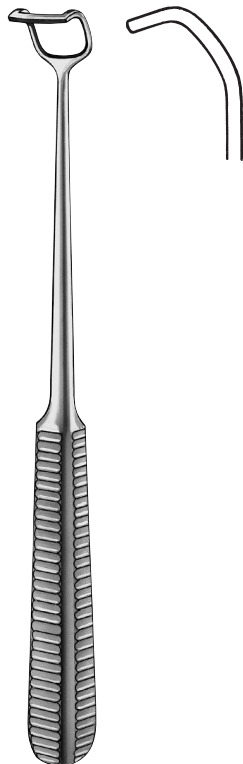

Beckmann
 22 cm/8¾"

RU 8350-01

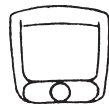

RU 8351-01

RU 8350-02



RU 8351-02

RU 8350-03



RU 8351-03

RU 8350-04



RU 8351-04

RU 8350-05



RU 8351-05

RU 8350-06



RU 8351-06

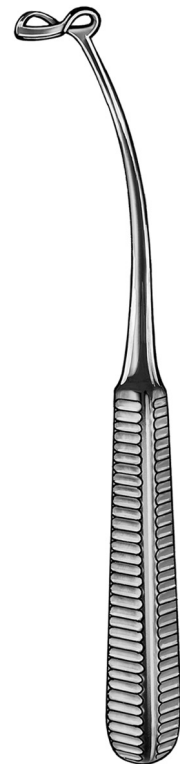

Negus
 22 cm/8¾"

Ringmesser
Adenoid cures



Barnhill
20 cm/8"

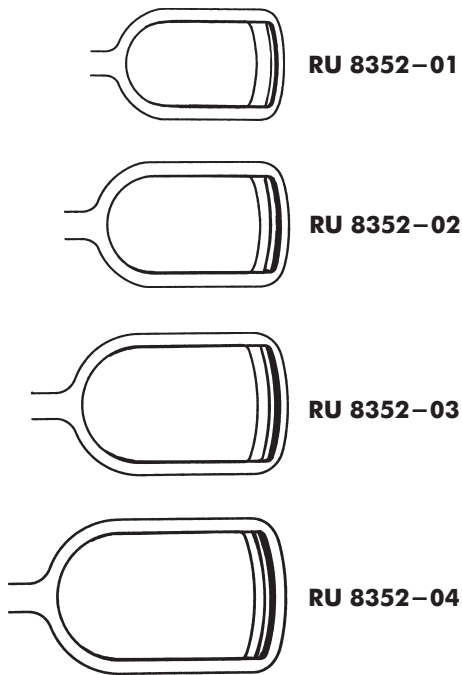

Beckmann
20 cm/8"

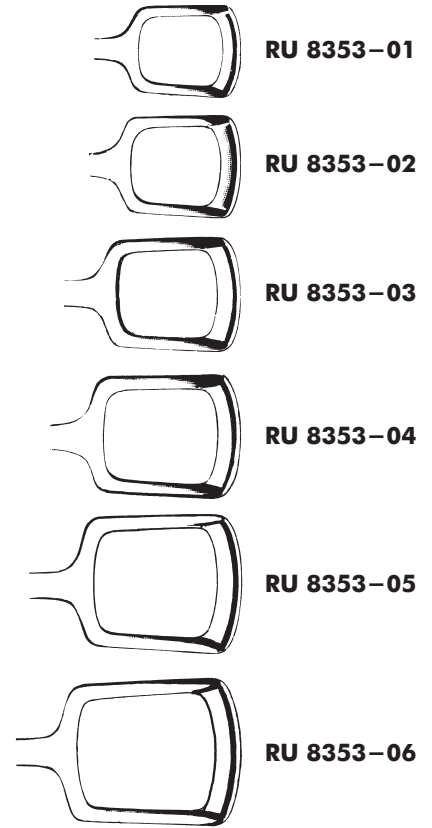

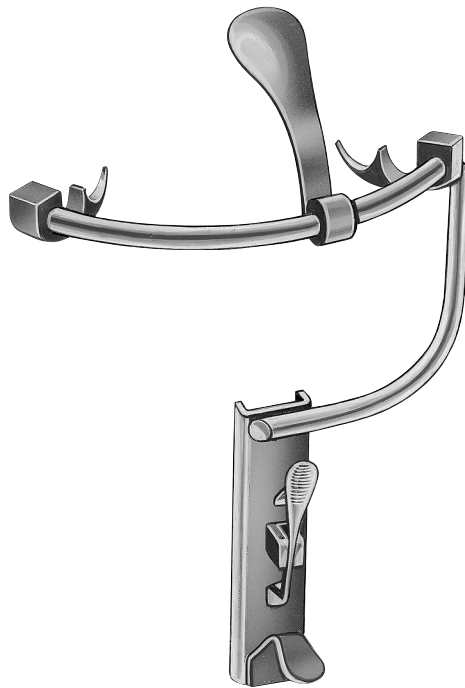

Kilner-Doughty

komplett mit 3 Spateln Fig. 1-3
 complete with 3 tongue-blades Fig. 1-3
RU 8380-00

Sperrer allein
 Gag only
RU 8380-10

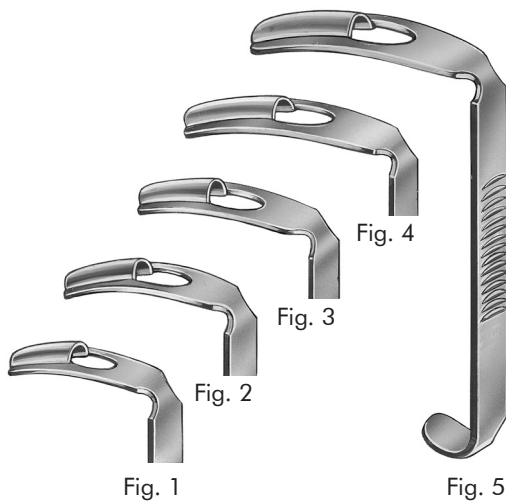

Zungenspatel/Tongue blades

- | | | |
|--------|-------------|-------------------|
| Fig. 1 | 28 x 65 mm | RU 8380-01 |
| Fig. 2 | 32 x 75 mm | RU 8380-02 |
| Fig. 3 | 37 x 80 mm | RU 8380-03 |
| Fig. 4 | 41 x 94 mm | RU 8380-04 |
| Fig. 5 | 46 x 103 mm | RU 8380-05 |

Alle auf den Seiten 258-263 abgebildeten Griffe und Spatel sind untereinander austauschbar.
 All the frames and blades illustrated on page 258 to 263 are interchangeable.

Mundsperrer, Zungenspatel
Mouth gags, Tongue blades



Davis-Meyer

Sperrer
 Gag
RU 8381-10

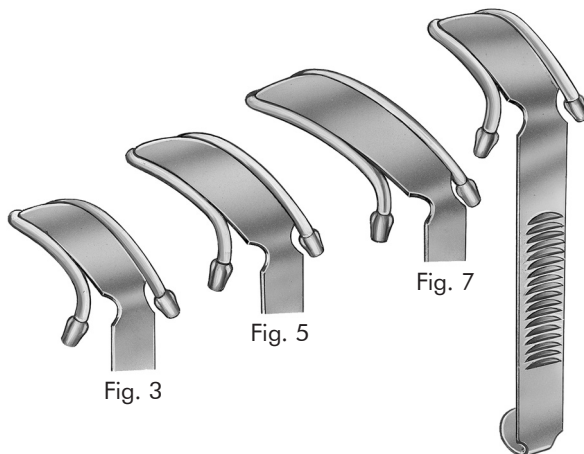

Fig. 5 33,5 x 95 mm **RU 8381-05**
 Fig. 6 33,8 x 100 mm **RU 8381-06**
 Fig. 7 34,0 x 105 mm **RU 8381-07**

Zungenspatel mit doppeltem Ätherrohr
 Tongue blades with anesthetic tubes on both sides



RU 8381-11
 Gaumenplatte
 Palate blade

Alle auf den Seiten 258-263 abgebildeten Griffe und Spatel sind untereinander austauschbar.
 All the frames and blades illustrated on page 258 to 263 are interchangeable.

Mundsperrer, Zungenspatel
Mouth gags, Tongue blades

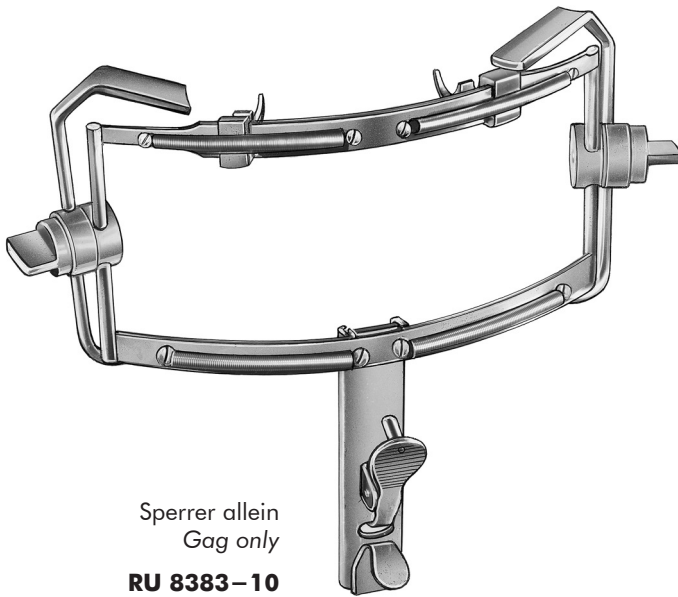

Sperrer allein
 Gag only
RU 8383-10

Dingmann

komplett mit
 3 auswechselbaren Zungenspateln (Fig. 1 – 3),
 2 drehbaren Wangenhaltern,
 2 beweglichen Zahnhaken
 und Fadenführer

complete with
 3 interchangeable tongue blades (Fig. 1 – 3),
 2 rotatable cheek holders,
 2 movable tooth hooks
 and thread guide

RU 8383-00

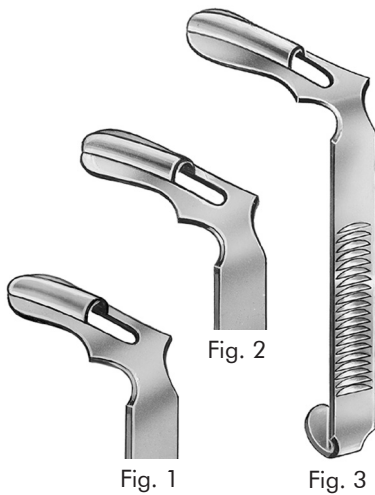

- Fig. 1 24 x 62 mm **RU 8383-01**
- Fig. 2 28 x 65 mm **RU 8383-02**
- Fig. 3 31 x 75 mm **RU 8383-03**

Zungenspatel
 Tongue blades

Alle auf den Seiten 258-263 abgebildeten Griffe und Spatel sind untereinander austauschbar.
 All the frames and blades illustrated on page 258 to 263 are interchangeable.

Mundsperrer, Zungenspatel
Mouth gags, Tongue blades



Sperrer allein
 Gag only

RU 8384-10

Davis-Boyle

für Erwachsene/for adults
 komplett mit 5 Spateln Fig. 1 – 5
 complete with 5 tongue blades Fig. 1 – 5

RU 8384-00

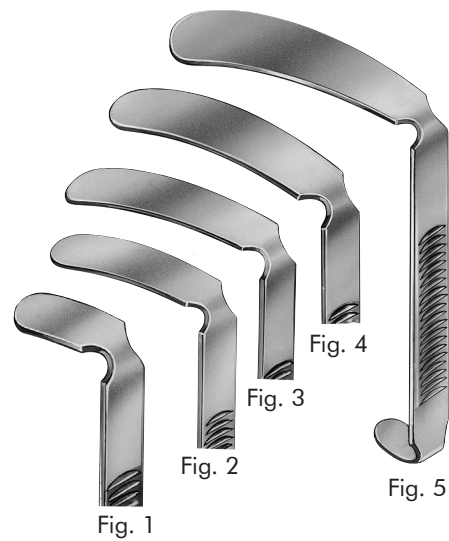

- | | | |
|--------|-------------|-------------------|
| Fig. 1 | 21 x 30 mm | RU 8384-01 |
| Fig. 2 | 23 x 65 mm | RU 8384-02 |
| Fig. 3 | 24 x 80 mm | RU 8384-03 |
| Fig. 4 | 25 x 93 mm | RU 8384-04 |
| Fig. 5 | 26 x 108 mm | RU 8384-05 |

Zungenspatel/tongue blades



Sperrer allein
 Gag only

RU 8384-14

Davis-Boyle

für Kinder/for children
 komplett mit 5 Spateln Fig. 1 – 5
 complete with 5 tongue blades Fig. 1 – 5

RU 8384-50

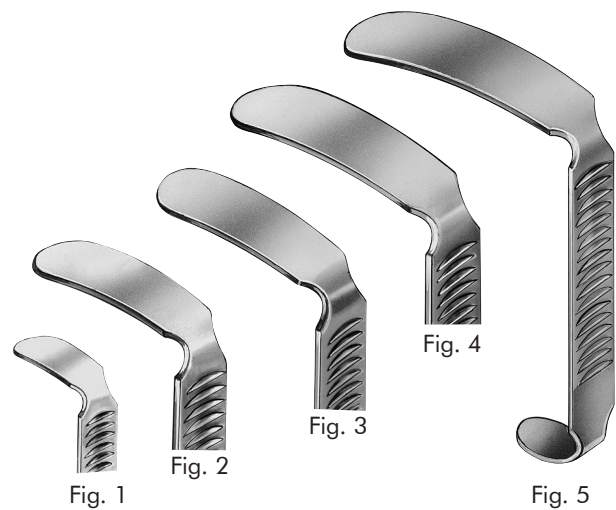

- | | | |
|--------|------------|-------------------|
| Fig. 1 | 17 x 26 mm | RU 8384-51 |
| Fig. 2 | 19 x 46 mm | RU 8384-52 |
| Fig. 3 | 20 x 58 mm | RU 8384-53 |
| Fig. 4 | 22 x 71 mm | RU 8384-54 |
| Fig. 5 | 22 x 80 mm | RU 8384-55 |

Zungenspatel/tongue blades

auswechselbare Silikoneinlagen für beide Sperrer
 removable silicone inserts for both gags

RU 8384-99

Alle auf den Seiten 258-263 abgebildeten Griffe und Spatel sind untereinander austauschbar.
 All the frames and blades illustrated on page 258 to 263 are interchangeable.

Mundsperrer, Zungenspatel
Mouth gags, Tongue blades



Sperrer allein
 Gag only
RU 8386-10

Mc Ivor

komplett mit 3 Spateln Fig. 1 – 3
 complete with 3 tongue blades Fig. 1 – 3

RU 8386-00

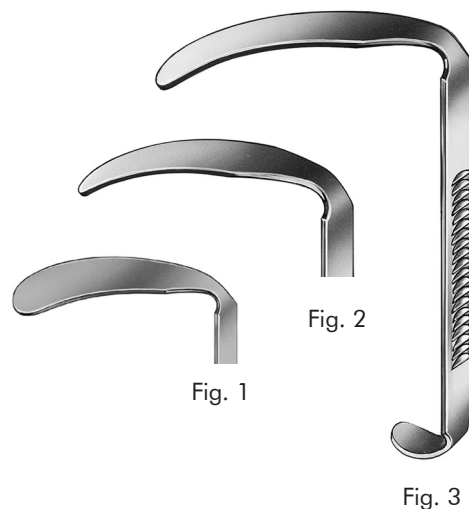

Fig. 1

Fig. 2

Fig. 3

Fig. 1 23 x 70 mm **RU 8386-01**

Fig. 2 25 x 86 mm **RU 8386-02**

Fig. 3 26 x 100 mm **RU 8386-03**

Zungenspatel/tongue blades



Herberhold

Fig. 2 33 x 73 mm **RU 8387-02**

Fig. 4 40 x 94 mm **RU 8387-04**



Modell Würzburg

Fig. 2 23 x 65 mm **RU 8388-02**

Fig. 3 24 x 80 mm **RU 8388-03**

Fig. 4 25 x 93 mm **RU 8388-04**

Fig. 5 26 x 108 mm **RU 8388-05**

Fig. 6 26 x 114 mm **RU 8388-06**

Fig. 1 28 x 66 mm **RU 8389-01**

Fig. 2 32 x 75 mm **RU 8389-02**

Fig. 3 34 x 83 mm **RU 8389-03**

Fig. 4 37 x 93 mm **RU 8389-04**

Fig. 5 38 x 100 mm **RU 8389-05**

Zungenspatel/tongue blades

Alle auf den Seiten 258-263 abgebildeten Griffe und Spatel sind untereinander austauschbar.
 All the frames and blades illustrated on page 258 to 263 are interchangeable.

Zungenspatel, Bruststütze
Tongue blades, chest support

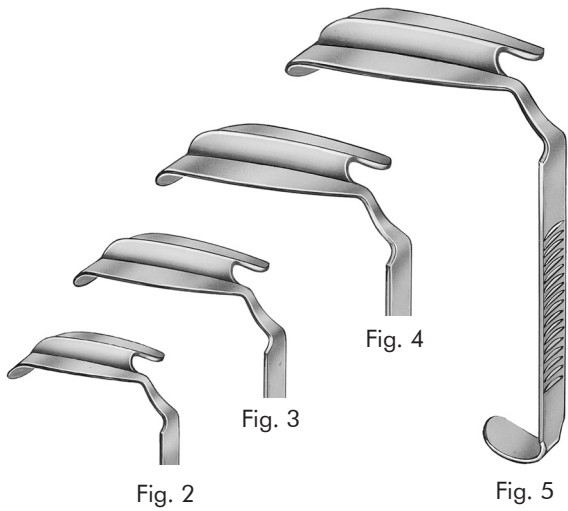

		links/left	rechts/right
Fig. 2	23 x 58 mm	RU 8390-02	—
Fig. 3	27 x 72 mm	RU 8390-03	RU 8390-53
Fig. 4	34 x 87 mm	RU 8390-04	RU 8390-54
Fig. 5	37 x 95 mm	RU 8390-05	RU 8390-55

mit seitlichem Einschnitt/lateral slot

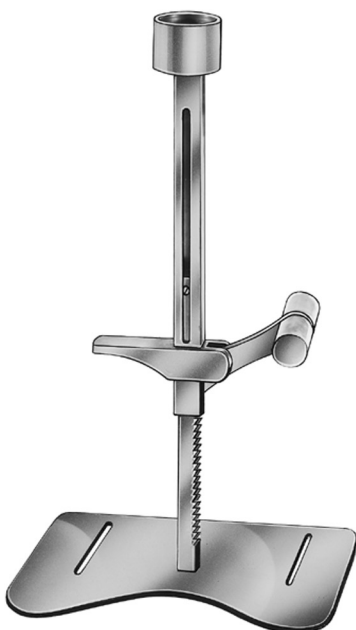

Bruststütze für Mundsperrer
Chest support for mouth gag

für Erwachsene/for adults

RU 8395-00

für Kinder/for children

RU 8395-03

Brustband
Chest support

zur Befestigung der Bruststütze
 for fastening the chest support

RU 8395-04



Alle auf den Seiten 256-261 abgebildeten Griffe und Spatel sind untereinander austauschbar.
 All the frames and blades illustrated on page 256 to 261 are interchangeable.



Baby-Molt
10 cm/4"
RU 8402-10



Molt
Doyen-Collin
11 cm/4½" **RU 8402-11**
14 cm/5½" **RU 8402-14**

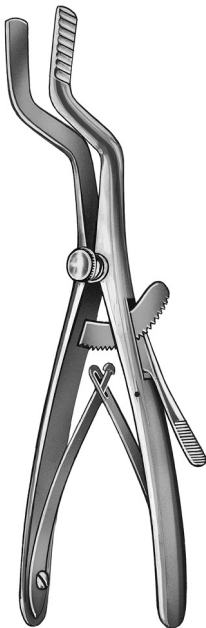

Roser-König
19 cm/7½"
RU 8405-19



Denhart
12 cm/4¾"
RU 8406-12

Mundsperrer, Wangenhalter
Mouth gags, cheek holder



Fergusson-Ackland
14,5 cm/5¾" **RU 8410-20**

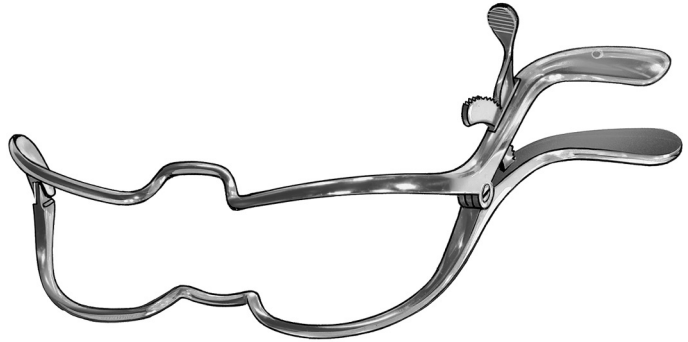

Jennings

- | | |
|-----------|-------------------|
| 9 cm/3½" | RU 8416-09 |
| 11 cm/4¼" | RU 8416-11 |
| 13 cm/5" | RU 8416-13 |
| 15 cm/6" | RU 8416-15 |



Sternberg
14 cm/5½"
RU 8421-14

Mund- und Zungenspatel
Mouth- and tongue depressors

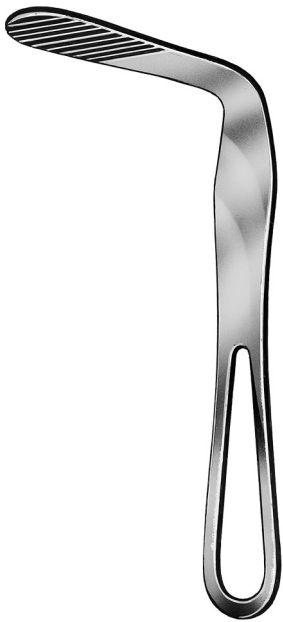

Hartmann
16,5 cm/6½"
RU 8425-15

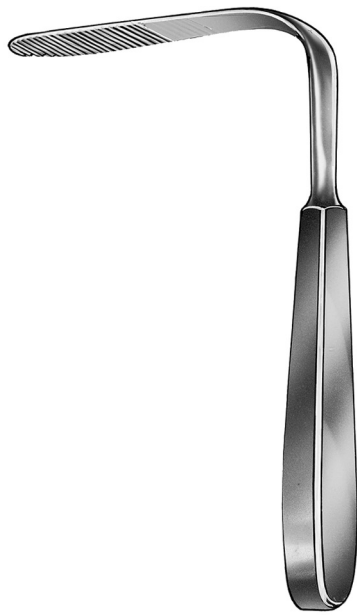

Tobold
14 cm/5½"
RU 8426-14



Frenzel
16,5 cm/6½"
RU 8429-16



14,5 cm/5¾"
RU 8430-14



14,5 cm/5¾"
RU 8431-14



Kroenig
15 cm/6"
RU 8432-15



Mayo
17 cm/6¾"
RU 8433-17

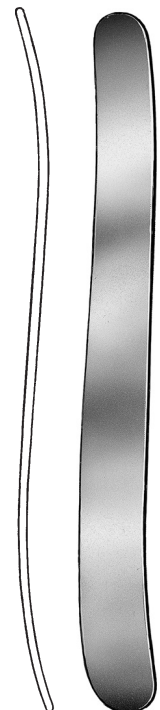

Buchwald
18 cm/7"
RU 8434-18

Zungenspatel, Zungenzangen
Tongue depressors, tongue holding forceps



Bruenings
19 cm/7½"
RU 8440-19



RU 8442-01 **RU 8442-02**

Wieder

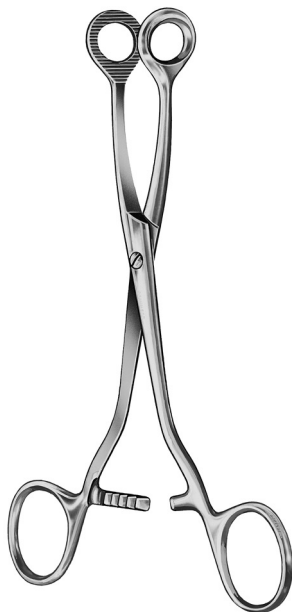

Collin
16 cm/6¼"
RU 8450-16



Young
17 cm/6¾"
RU 8452-17

Paar Gummipolster, allein
Pair of rubber jaws, only

RU 8452-50

Tamponstopfer, Tonsillennadeln, Ligaturinstrumente
Gauze packers, tonsil needles, ligature instruments

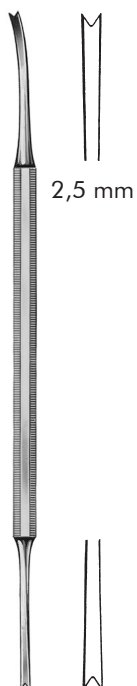

Luniatschek
18 cm/7"
RU 8458-01

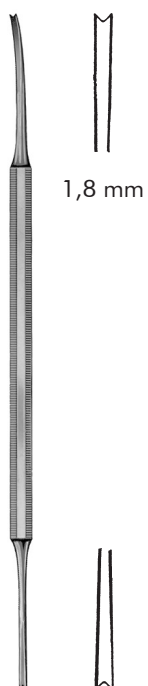

Luniatschek
18 cm/7"
RU 8458-02



Hurd
21 cm/8¼"
RU 8503-01
für rechte Hand
for right hand

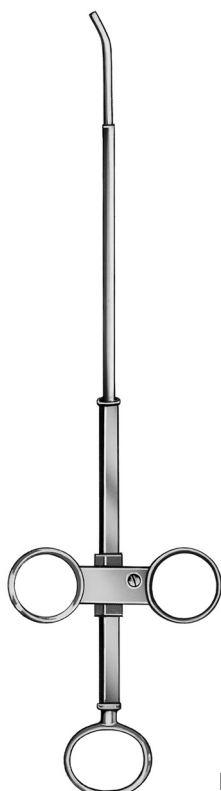

Roeder
26 cm/10¼"
RU 8520-26



Negus
20 cm/8"
RU 8524-20

Tonsillenmesser, Elevatorien
Tonsil knives, elevators



Abraham
21 cm/8¼"
RU 8538-21



Bruenings
23 cm/9"
RU 8539-23



Hurd
22,5 cm/8¾"
7 mm **RU 8542-08**
10 mm **RU 8542-22**

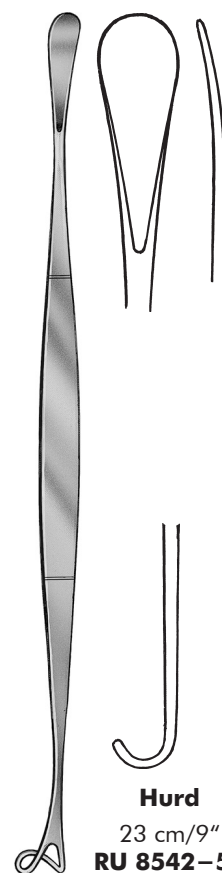

Hurd
23 cm/9"
RU 8542-50

11,5 mm

Elevatoren
Elevators

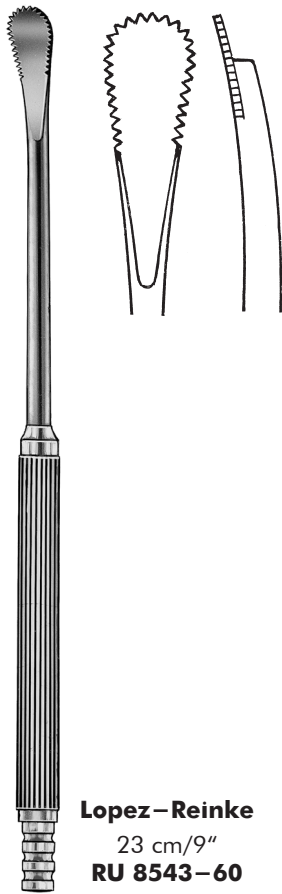

Lopez-Reinke
23 cm/9"
RU 8543-60

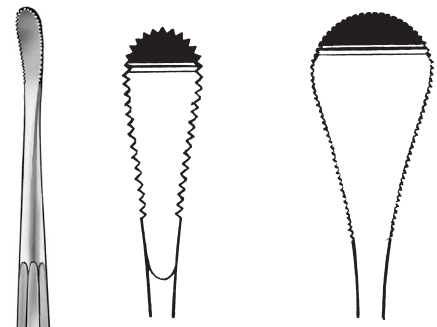

11,5 mm
RU 8545-01

15 mm
RU 8545-02



Henke
23 cm/9"



Nager
23 cm/9"
RU 8546-23

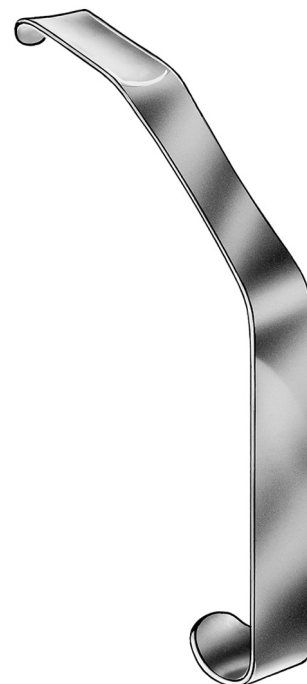

Love
18 mm
RU 8547-18

Tonsillenfasszangen
Tonsil grasping forceps



Allis

15 cm/6"

Zähne 4:5 **RU 6500-15**
teeth 5:6 **RU 6502-15**

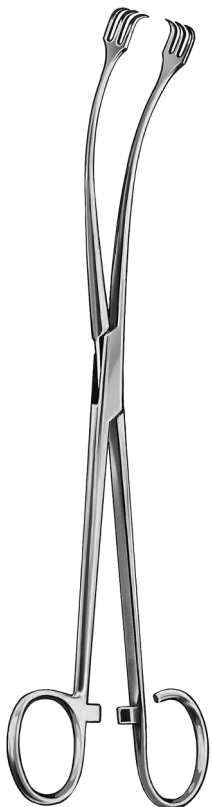

Ballenger

21,5 cm/8½"
RU 8553-21

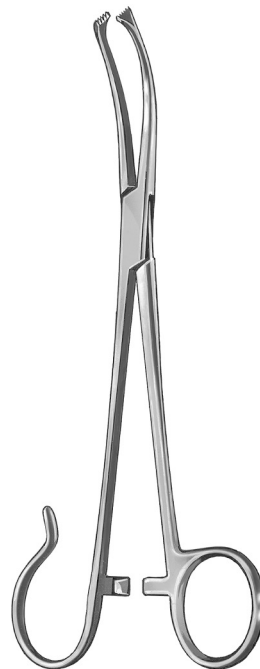

White

18 cm/7" **RU 8555-18**
23 cm/9" **RU 8555-23**

Tonsillenfasszangen, Tonsillenklemmen
Tonsil grasping forceps, tonsil hemostatic forceps

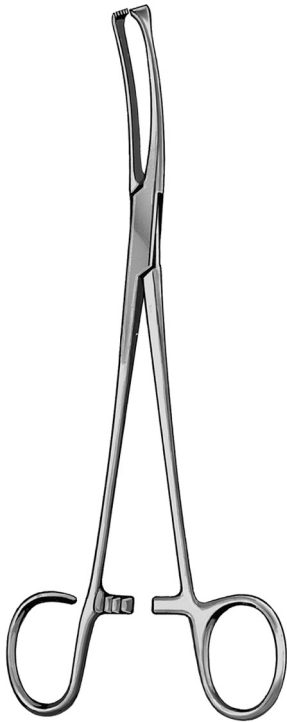

Colver

19 cm/7½"

gerade/straight gebogen/curved
RU 8556-19 RU 8557-19

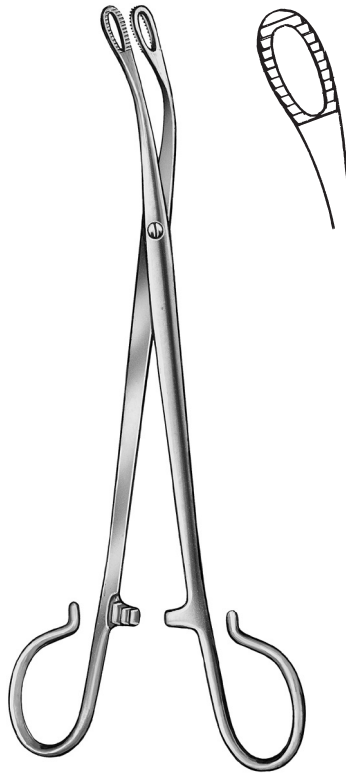

Abraham

20 cm/8"

RU 8559-20

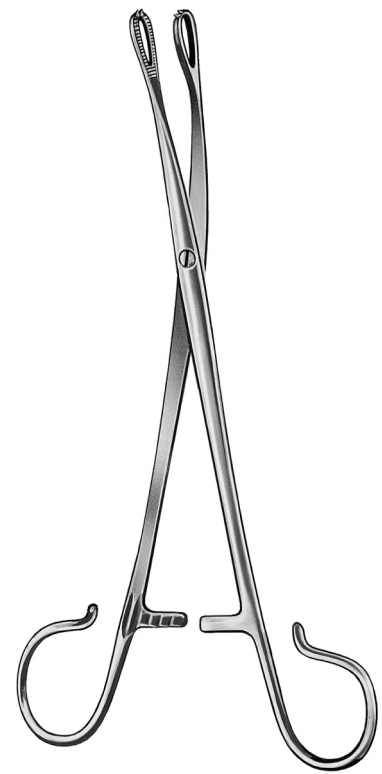

Blohmke

20 cm/8"

RU 8560-20



Schnidt

19 cm/7½"

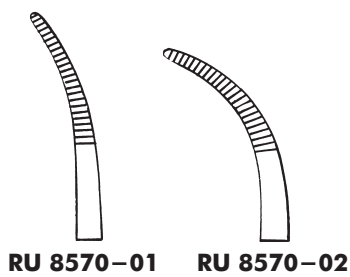

RU 8570-01

RU 8570-02

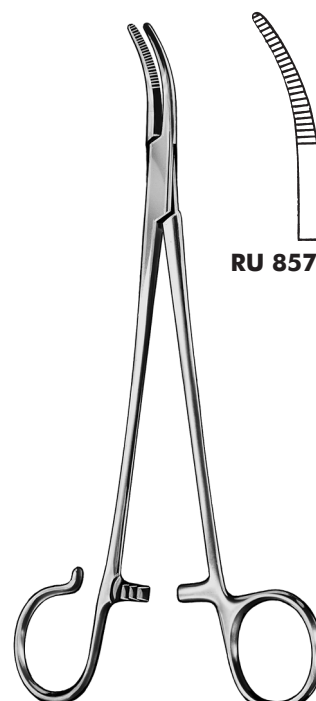

Schnidt

19 cm/7½"

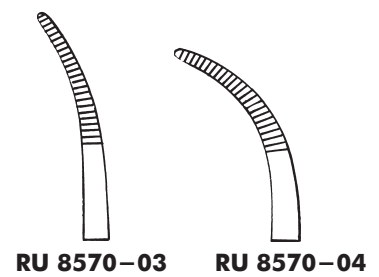

RU 8570-03

RU 8570-04

Tonsillenschnürer
Tonsil snares



Eves
28 cm/11"
RU 8600-28



	12 St./12 pcs.	100 St./100 pcs.
0,3 mm	RU 8609-03	RU 8609-03/00
0,4 mm	RU 8609-04	—
0,45 mm	RU 8609-05	RU 8609-05/00
0,5 mm	RU 8609-06	RU 8609-06/00

Schnürerdraht
Snare wire

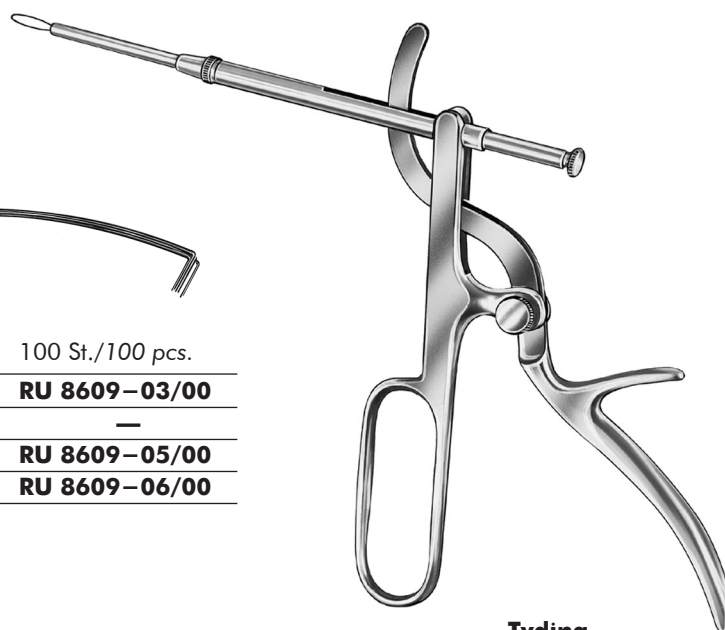

Tyding
mit 1 geraden Aufsatz
with 1 straight tip
RU 8608-00

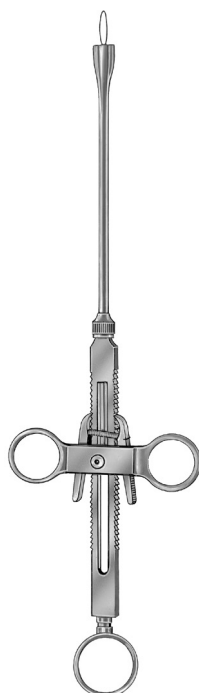

Bruenings
28 cm/11"
RU 8604-28

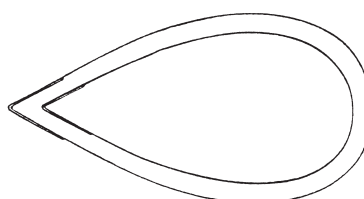

	100 St./100 pcs.
40 mm	RU 8609-40
50 mm	RU 8609-50

Schnürerschlingen
Snare loops

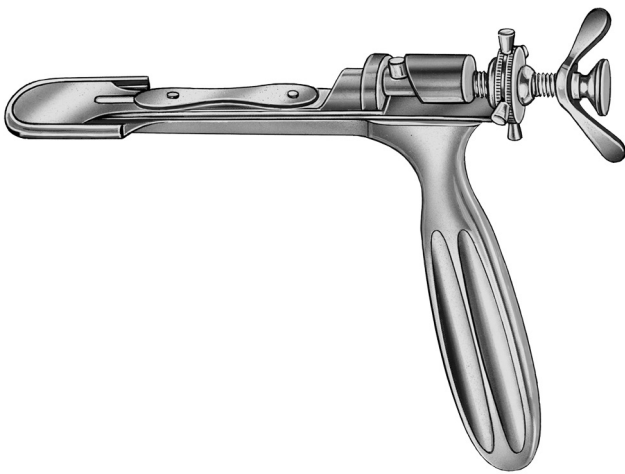

Daniels

mit Doppelklinge zum Quetschen und Schneiden
with double blade for squeezing and cutting

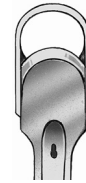

Fig. 2
 20 mm
RU 8614-02

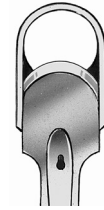

Fig. 3
 24 mm
RU 8614-03

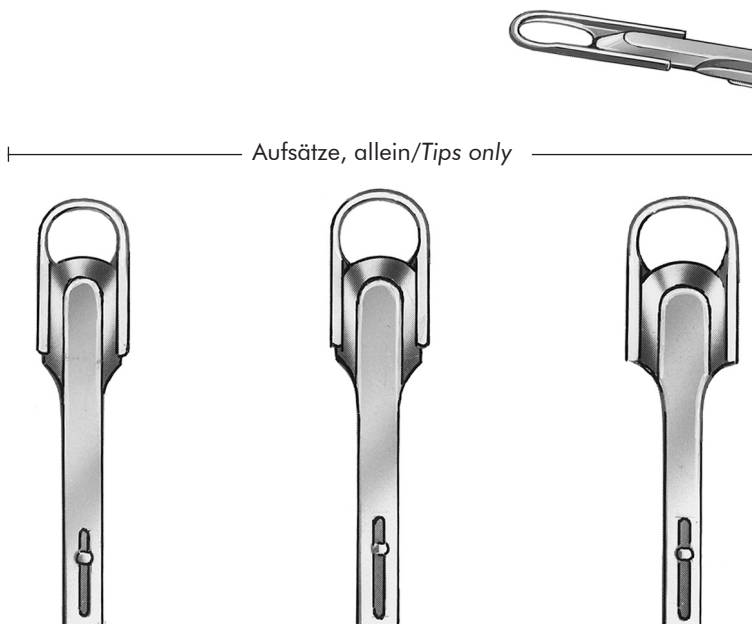
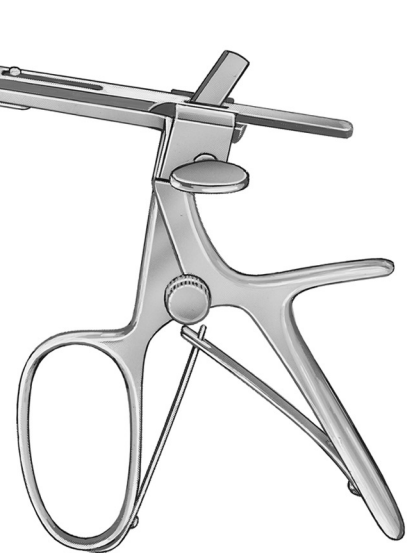

Fig. 1
 24 mm
RU 8615-01

Fig. 2
 26 mm
RU 8615-02

Fig. 3
 29 mm
RU 8615-03



Sluder-Ballenger

komplett mit 3 Aufsätzen (Fig. 1 – 3)
complete, with 3 tips (Fig. 1 – 3)
RU 8615-00

RU 8615-10

Griff allein
Handle only

Tonsillen-Conchotome
Tonsil punches



Hartmann

- Ø 13 mm **RU 8616-13**
- Ø 15 mm **RU 8616-15**



Wundhaken	<i>Retractors</i>	279
Wangenhalter, Wundsperrerr	<i>Cheek Retractors, Spreaders</i>	280 — 281
Nasenzangen	<i>Nasal Forceps</i>	282
Septumzangen, Biopsie- und Fasszangen	<i>Septum Forceps, Biopsy and Grasping Forceps</i>	283
Siebbeinzangen	<i>Ethmoidal Forceps</i>	284 — 285
Nasenrachen-Biopsiezange	<i>Nasopharyngeal Biopsy Forceps</i>	286
Micro-Zängchen u. -Scheren, Kieferhöhlen-Stanzen	<i>Micro-Forceps and -Scissors, Antrum Punches</i>	287
Kieferhöhlen-Stanzen, Micro-Stanzen	<i>Antrum Punches, Micro-Punches</i>	288
Zirkular-Stanzen	<i>Circular Cutting Punches</i>	289
Kieferhöhlen-Fasszangen, Nasenstanzen	<i>Maxillarysinus Grasping Forceps, Nasal Punches</i>	290
Doppellöffel-Zangen	<i>Forceps, Cupped Jaws</i>	291
Nasenscheren, Nasenrachenzange	<i>Nasal Scissors, Nasopharynx Forceps</i>	292
Stirnhöhlenstanzen, Biopsie- und Fasszangen	<i>Sinus Punches, Biopsy Forceps, Grasping Forceps</i>	293
Kieferhöhlenstanzen	<i>Antrum Punches</i>	294, 298
Zerlegbare Knochenstanzen ProClean	<i>Detachable Bone Rongeurs ProClean</i>	295 — 297
Sichelmesser, Kieferhöhlen- und Stirnhöhlenlöffel	<i>Sickle Knives, Maxillary- and Frontal Sinus Curettes</i>	299
Scharfe Löffel	<i>Sharp Curettes</i>	300
Kieferhöhlenmeißel und -Raspel	<i>Antrum Chisel and Rasp</i>	301
Kieferhöhlen-Elevatorien und Küretten	<i>Elevators, Antrum Curettes</i>	302
Kanülen, Dilatatoren, Sonden	<i>Cannulas, Dilators, Probes</i>	303
Sinuskopie-Trokare	<i>Sinuscopy Trocars</i>	304



Baby-Roux
13 cm/5"
RU 4492-13

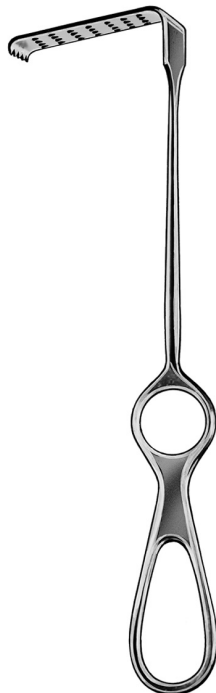

Brünings-Brunk
22,5 cm/8³/₄"
RU 8363-19



Middeldorpf



RU 4551-01

14 x 17 mm
21,5 cm/8¹/₂"



RU 4551-02

20 x 22 mm
22 cm/8³/₄"



RU 4551-03

26 x 30 mm
23,5 cm/9¹/₄"

Wangenhalter, Wundsperrer
Cheek retractors, spreaders

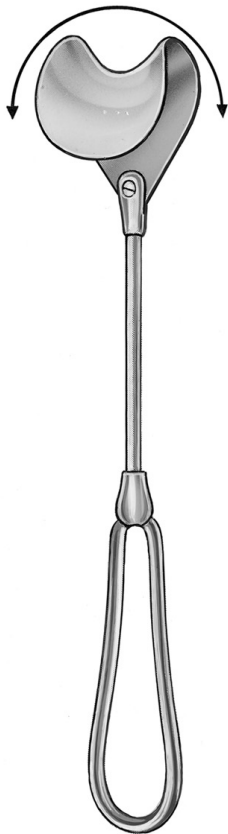

19 cm/7½"
RU 8420-19



Sternberg
 14 cm/5½"
RU 8421-14

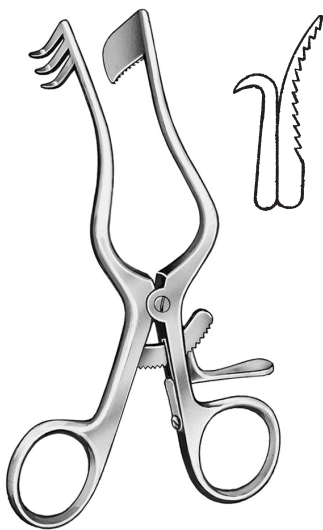

Perkins
 13 cm/5"
 rechtes Blatt voll/scharf gezahnt
 solid blade right/coarse serrated
RU 4688-01

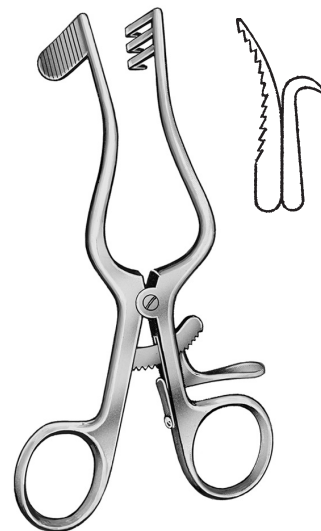
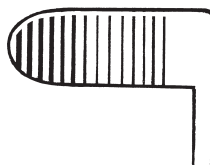

Perkins
 13 cm/5"
 linkes Blatt voll/scharf gezahnt
 solid blade left/coarse serrated
RU 4688-02



Plester
 11 cm/4½"
RU 4690-01



Plester
 11 cm/4½"
RU 4690-02

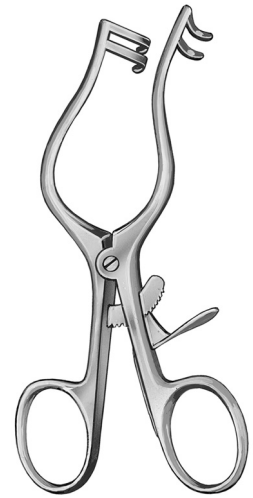

Plester
 13 cm/5"
 scharf/sharp stumpf/blunt
RU 4691-01 RU 4691-02

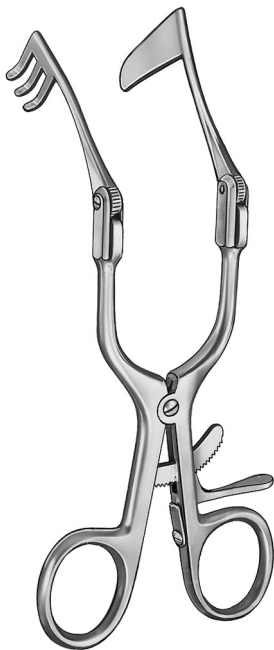

verstellbar/adjustable

Blatt/blade 17 cm/6¾"
 25 x 17 mm **RU 4694-05**



17 cm/6¾"
RU 4694-06

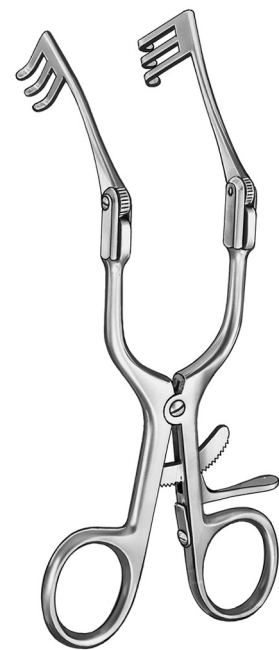

verstellbar/adjustable

Fisch
 17 cm/6¾"
RU 4694-11

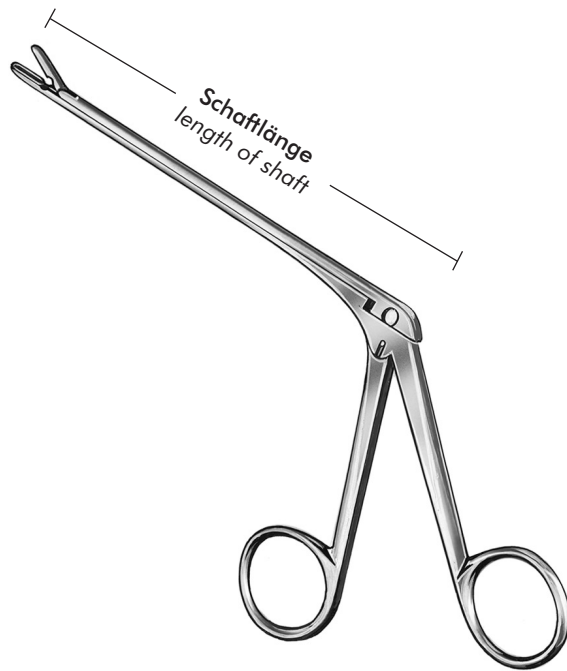

Takahashi

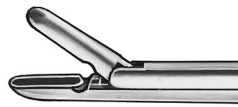

Maul Jaw	Schaftlänge length of shaft		Schaftlänge length of shaft
	12 cm/4 ³ / ₄ "	17 cm/6 ³ / ₄ "	12 cm/4 ³ / ₄ "
3 x 10 mm	RU 8080-00	RU 8080-10	RU 8081-00
2 x 10 mm	RU 8080-02	RU 8080-12	-
2,5 x 8 mm	RU 8080-03	-	-

Septumzangen, Biopsie- und Fasszangen
Septum forceps, biopsy and grasping forceps



6 mm
RU 8085-01

8 mm
RU 8085-02

10 mm
RU 8085-03

6,5 mm
RU 8086-00



Watson-Williams
 19 cm / 7 1/2"

1,0 x 19 mm



Struycken
RU 8094-00

1,2 x 19 mm



Hajek
RU 8095-00



Hajek
RU 8102-01
 3,0 mm x 12 mm

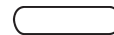

RU 8102-02
 3,5 mm x 14 mm



RU 8102-03
 4,0 mm x 16 mm

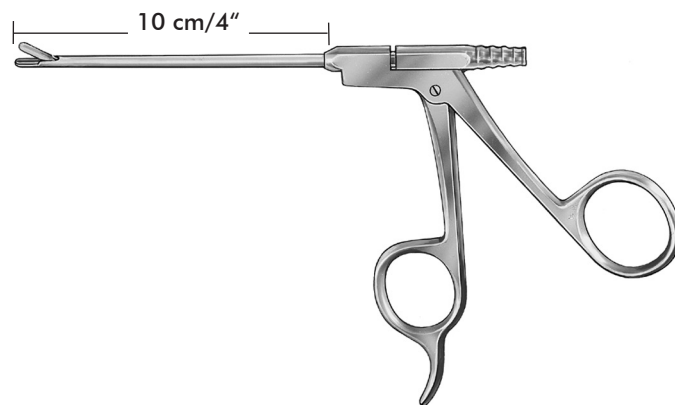

8,5 mm x 4,0 mm



RU 8089-00 gerade, straight

8,5 mm x 4,0 mm







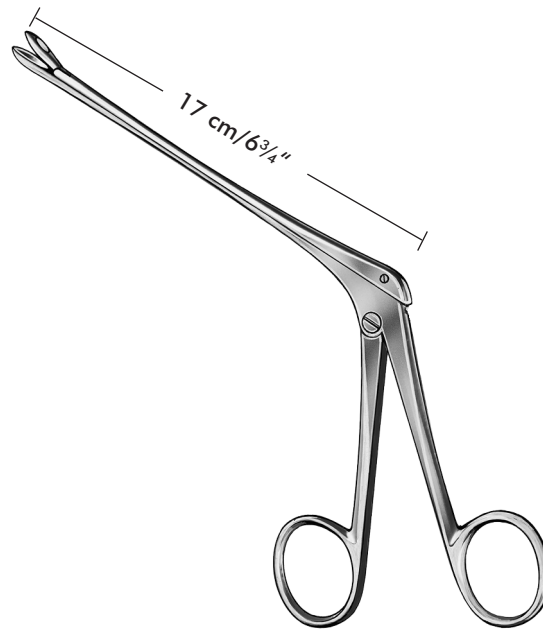

RU 8089-01 30° aufgewinkelt, 30° angled up

Biopsie- und Fasszange
 mit Absaugkanal
Biopsy and grasping forceps
 with suction channel

Siebbeinzangen
Ethmoidal forceps



Weil-Blakesley

				
		<i>gerade/straight</i>	45° aufwärts gebogen <i>45° angled up</i>	90° aufwärts gebogen <i>90° angled up</i>
2,5 mm		RU 8090-10	RU 8091-10	RU 8092-10
3,0 mm		RU 8090-11	RU 8091-11	RU 8092-11
3,5 mm		RU 8090-12	RU 8091-12	RU 8092-12

Siebbeinzangen
Ethmoidal forceps



Blakesley Siebbeinzangen mit modifiziertem, durchschneidendem Maul.
Blakesley ethmoid forceps with modified, intersecting jaw.

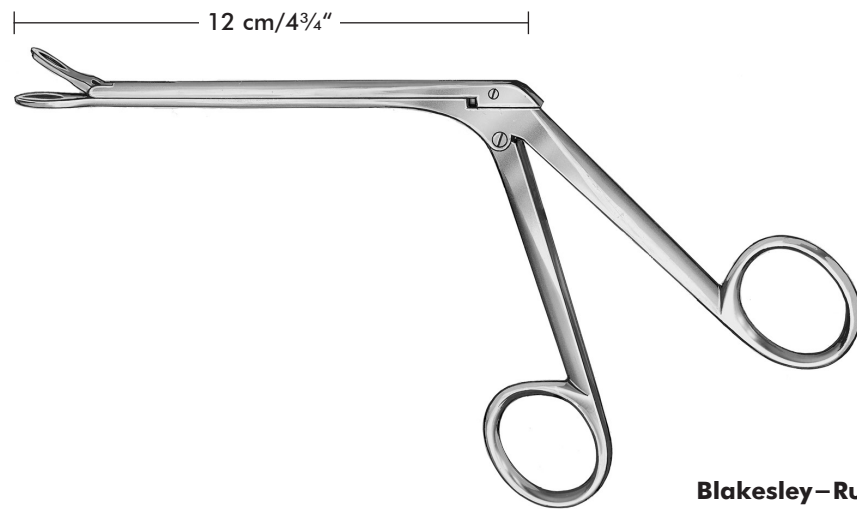

Blakesley–Rudolf



Größe Size	Maul gerade <i>straight jaw</i>	Maul aufgewinkelt <i>jaw angled up</i>	Maul nach links schneidend <i>left cutting</i>	Maul nach rechts schneidend <i>right cutting</i>
Fig. 0/2,5 mm	RU 8090–20	RU 8091–20	—	—
Fig. 2/3,5 mm	RU 8090–22	RU 8091–22	RU 8090–22L	RU 8090–22R
Fig. 4/4,8 mm	RU 8090–24	RU 8091–24	—	—

Nasenrachen-Biopsizange
Nasopharyngeal biopsy forceps

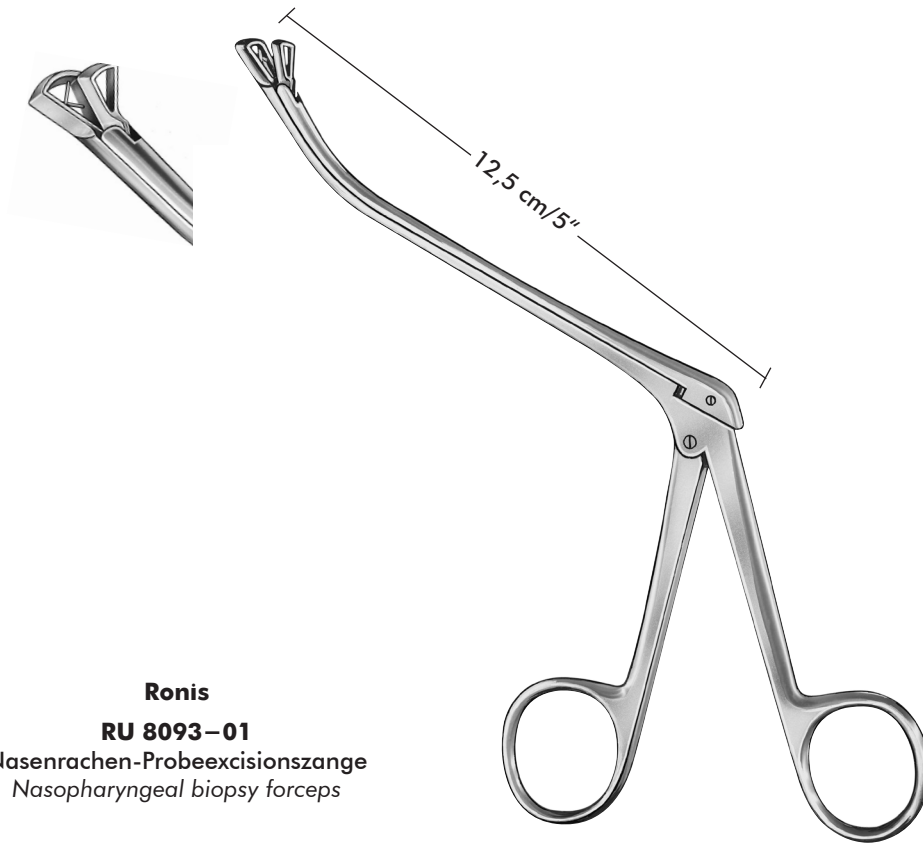

Ronis
RU 8093-01
Nasenrachen-Probeexcisionszange
Nasopharyngeal biopsy forceps

Micro-Zängchen und -Scheren, Kieferhöhlen-Stanzen
Micro-forceps and -scissors, antrum punches

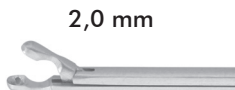
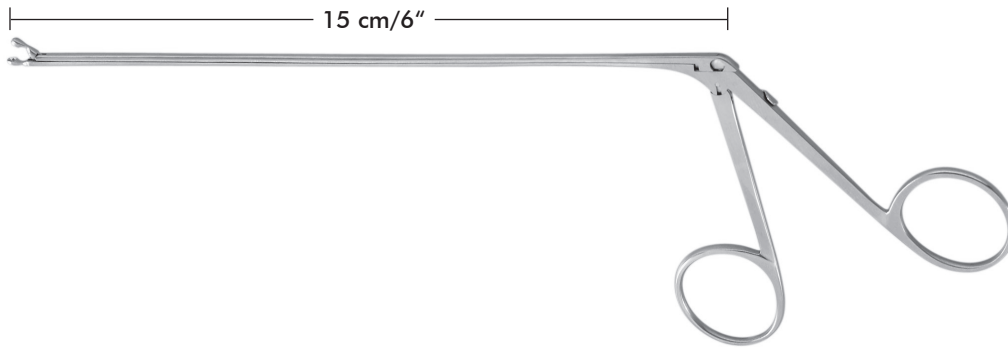

2,0 mm
Löffelmaul
spoon shaped jaw

RU 8111-01

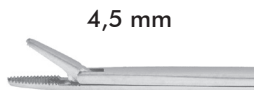

4,5 mm
Fasszange fein
grasping forceps fine

RU 8111-02

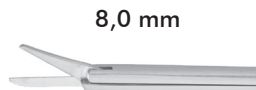

8,0 mm
Schere
scissors

RU 8111-04

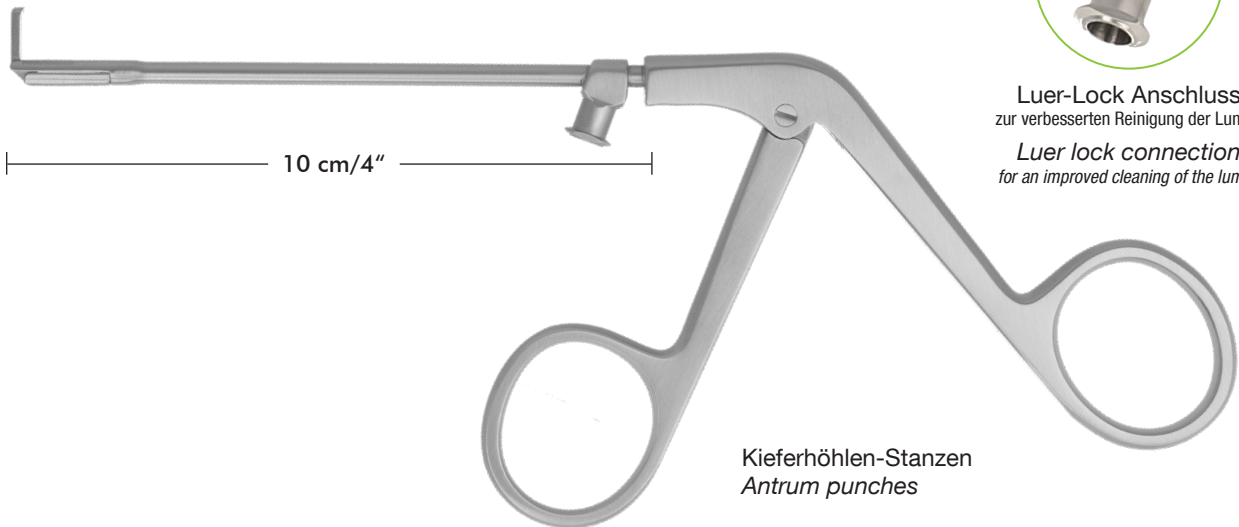

Luer-Lock Anschluss
 zur verbesserten Reinigung der Lumen
Luer lock connection
 for an improved cleaning of the lumen

Kieferhöhlen-Stanzen
Antrum punches

		Schnittbreite / cutting width 2,5 mm	Schnittbreite / cutting width 1,5 mm
nach oben schneidend <i>upwards cutting</i>		RU 8112-00	RU 8112-50
nach rechts schneidend <i>right cutting</i>		RU 8112-01	RU 8112-51
nach links schneidend <i>left cutting</i>		RU 8112-02	RU 8112-52

Kieferhöhlen-Stanzen, Micro-Stanzen

Antrum punches, micro-punches

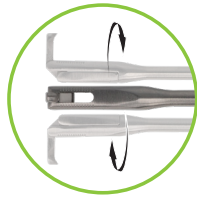

360° drehbar,
mit 8 Raststellungen
360° rotatable,
with 8 catch positions



Luer-Lock Anschluss
zur verbesserten Reinigung der Lumen
Luer lock connection
for an improved cleaning of the lumen

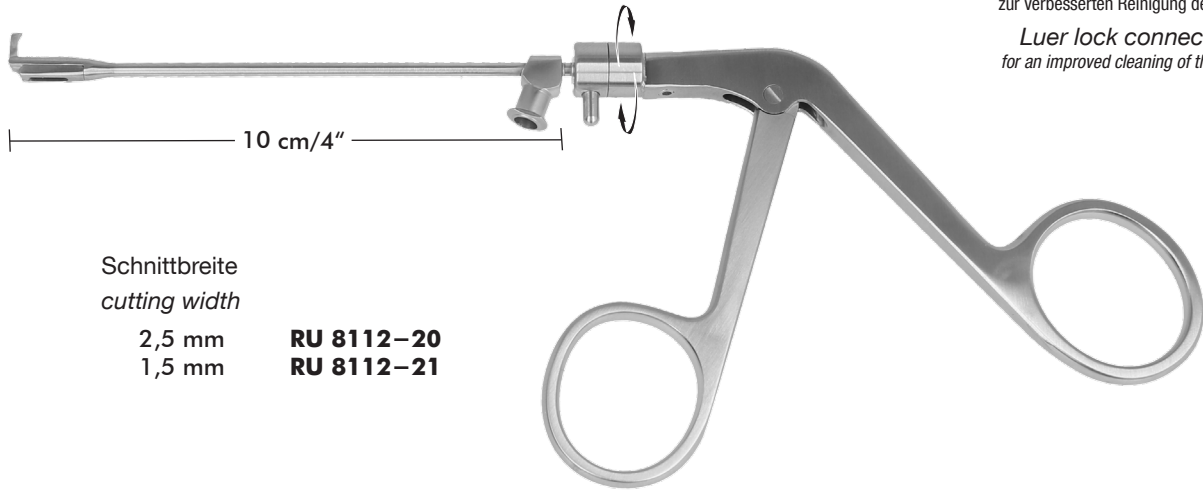

Schnittbreite
cutting width

2,5 mm
1,5 mm

RU 8112-20
RU 8112-21

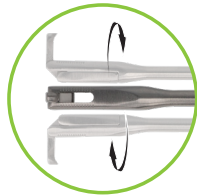

360° drehbar,
mit 8 Raststellungen
360° rotatable,
with 8 catch positions



Luer-Lock Anschluss
zur verbesserten Reinigung der Lumen
Luer lock connection
for an improved cleaning of the lumen

Mikro-Stanze
Micro-punch

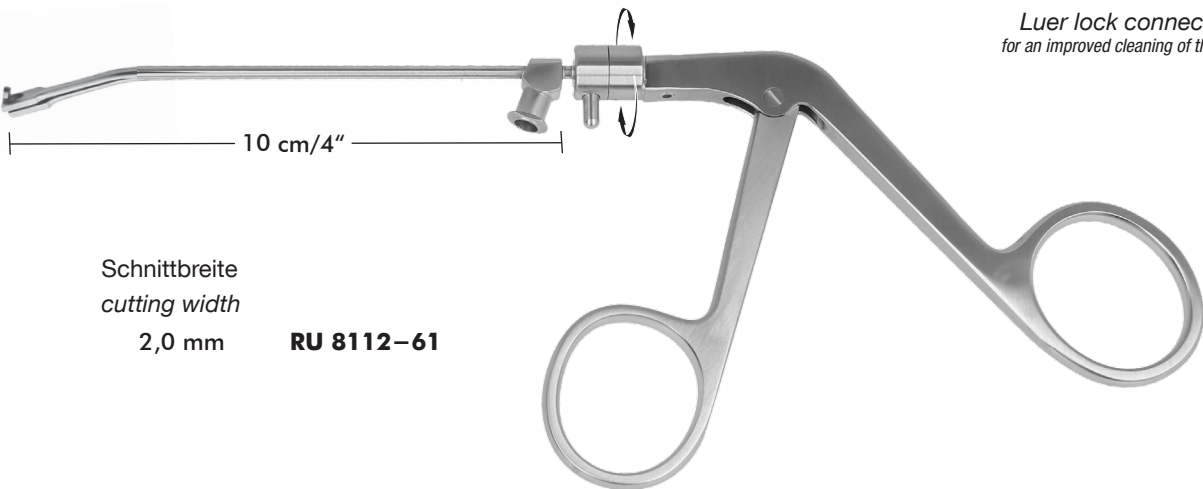

Schnittbreite
cutting width

2,0 mm

RU 8112-61

Zirkular-Stanzen Circular cutting punches

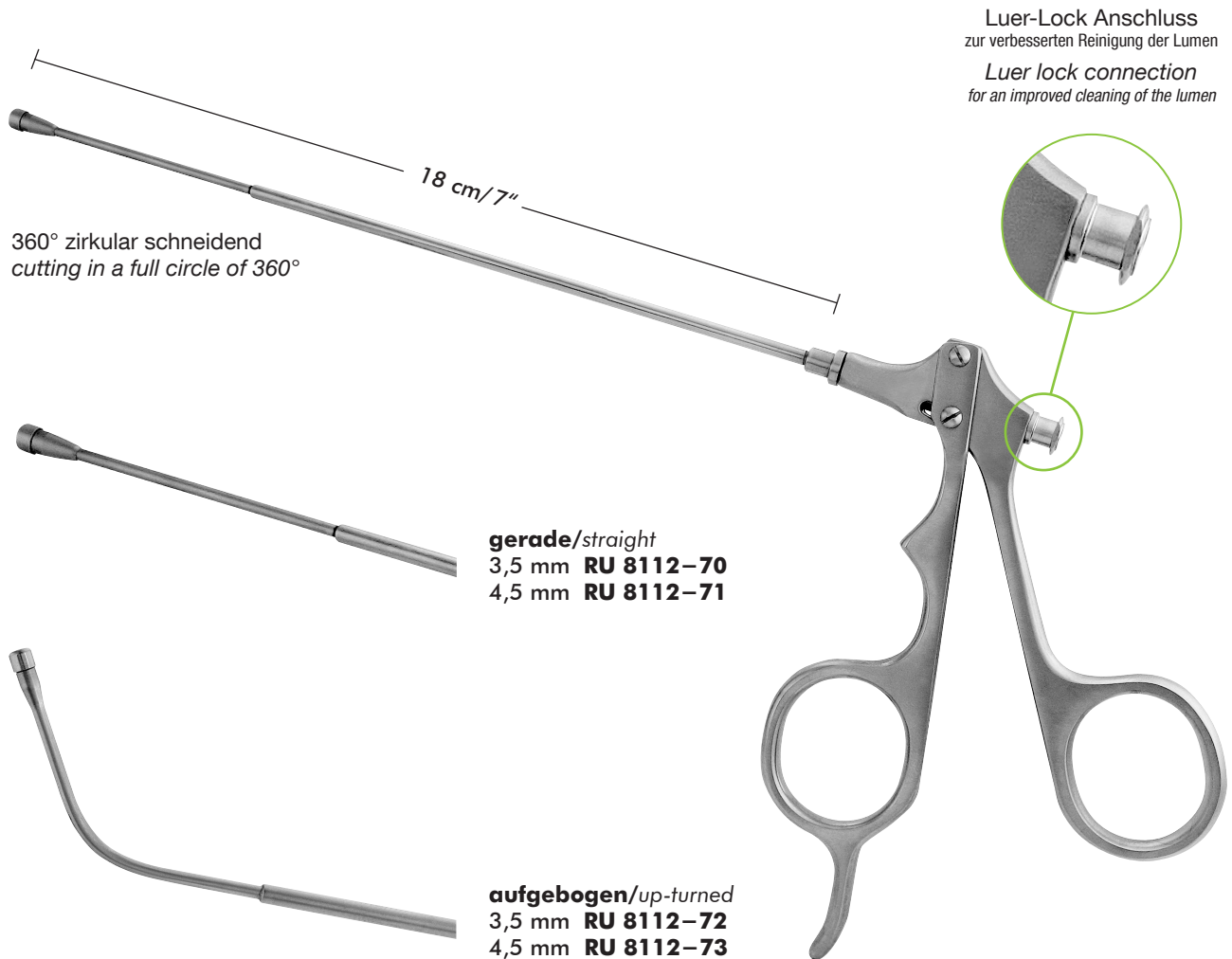

Kieferkühlen-Fasszangen, Nasenstanzen
Maxillary sinus grasping forceps, nasal punches

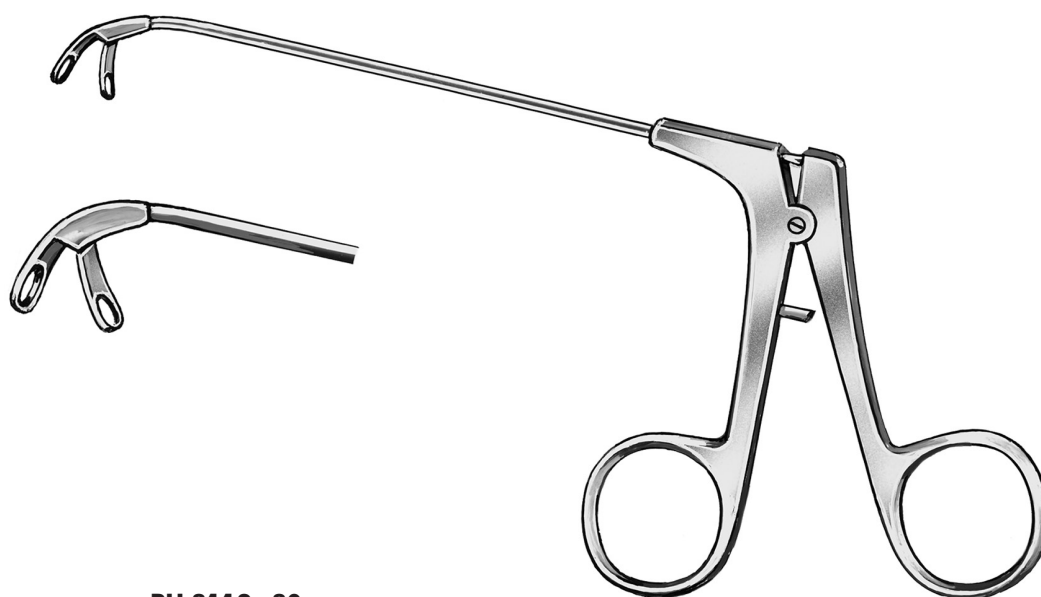

RU 8112-80

Kieferhöhlen-Faßzange zur Entfernung von Zysten und Polypen,
 bewegliches Maulteil bis 120°, rückwärts öffnend, Nutzlänge 10 cm/4"
*Antrum grasping forceps, for endonasal removal
 of cysts and polyps, retrograd opening jaws 120°, working length 10 cm/4"*

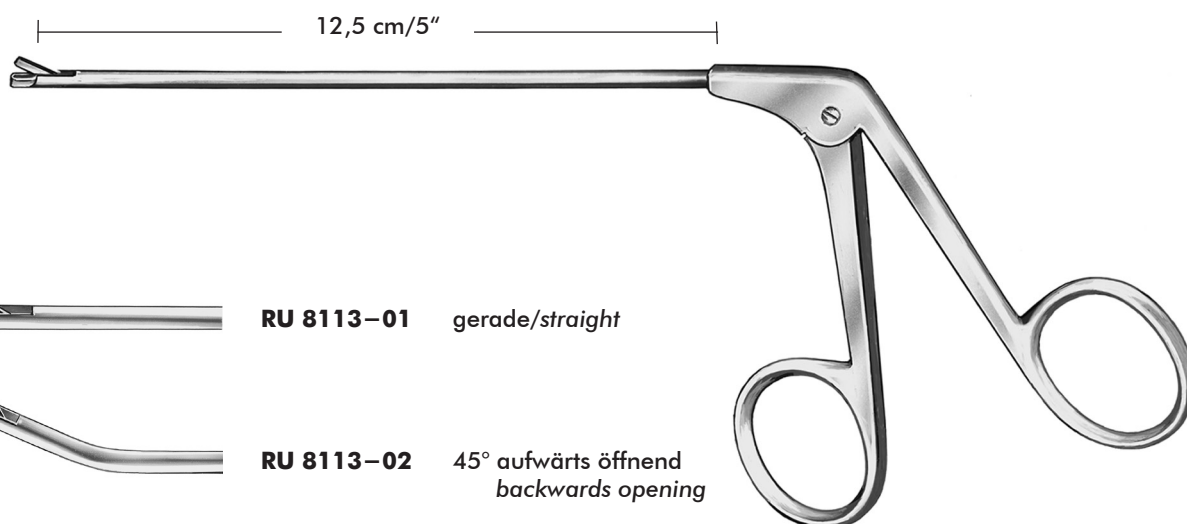

 **RU 8113-01** gerade/straight

 **RU 8113-02** 45° aufwärts öffnend
backwards opening

 **RU 8113-03** 45° abwärts öffnend
forwards opening

Nasenstanzen
Nasal punches

Doppellöffel-Zangen
Forceps, cupped jaws

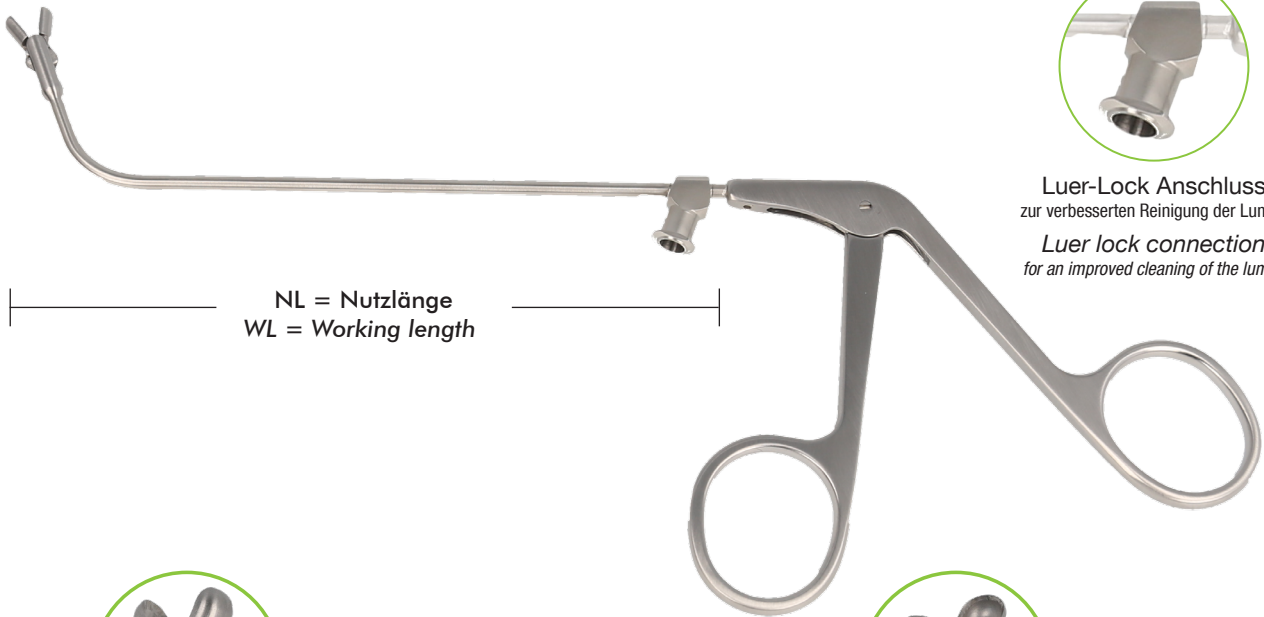

Luer-Lock Anschluss
 zur verbesserten Reinigung der Lumen
*Luer lock connection
 for an improved cleaning of the lumen*

NL = Nutzlänge
 WL = Working length



vertikal öffnend
 vertical cutting

70°

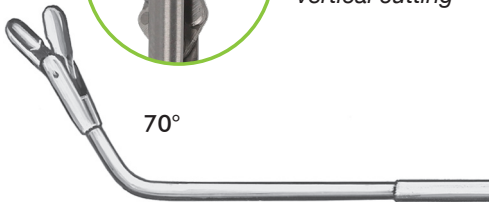

Ø 4 mm NL/WL = 12cm **RU 8114-01**
 Ø 3 mm NL/WL = 9,5cm **RU 8114-01/03**



horizontal öffnend
 horizontal cutting

70°



Ø 4 mm NL/WL = 12cm **RU 8114-03**
 Ø 3 mm NL/WL = 9,5cm **RU 8114-03/03**



90°

Ø 4 mm NL/WL = 12cm **RU 8114-05**
 Ø 3 mm NL/WL = 12cm **RU 8114-05/03**

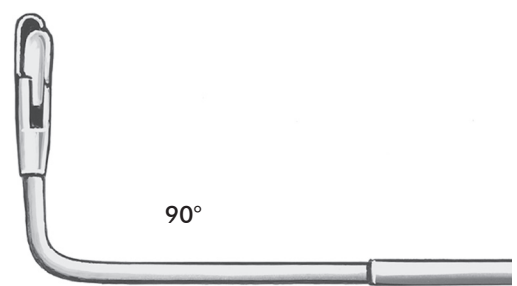

90°

Ø 4 mm NL/WL = 12cm **RU 8114-06**
 Ø 3 mm NL/WL = 12cm **RU 8114-06/03**

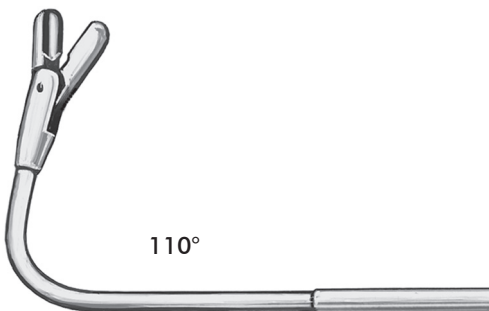

110°

Ø 4 mm NL/WL = 8cm **RU 8114-02**
 Ø 3 mm NL/WL = 8cm **RU 8114-02/03**



110°

Ø 4 mm NL/WL = 8cm **RU 8114-04**
 Ø 3 mm NL/WL = 8cm **RU 8114-04/03**

Nasenscheren, Nasenrachenzange
Nasal scissors, nasopharynx forceps



Nasenscheren
Nasal scissors

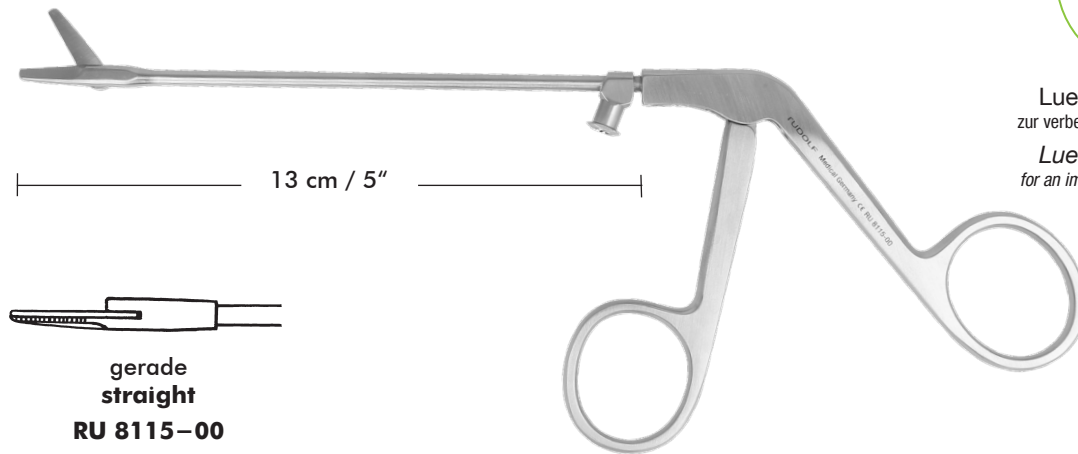

Luer-Lock Anschluss
 zur verbesserten Reinigung der Lumen
Luer lock connection
 for an improved cleaning of the lumen

13 cm / 5"



gerade
 straight
RU 8115-00



rechts gebogen
 curved right
RU 8115-01



links gebogen
 curved left
RU 8115-02

Nasenrachenzange
Nasopharynx forceps

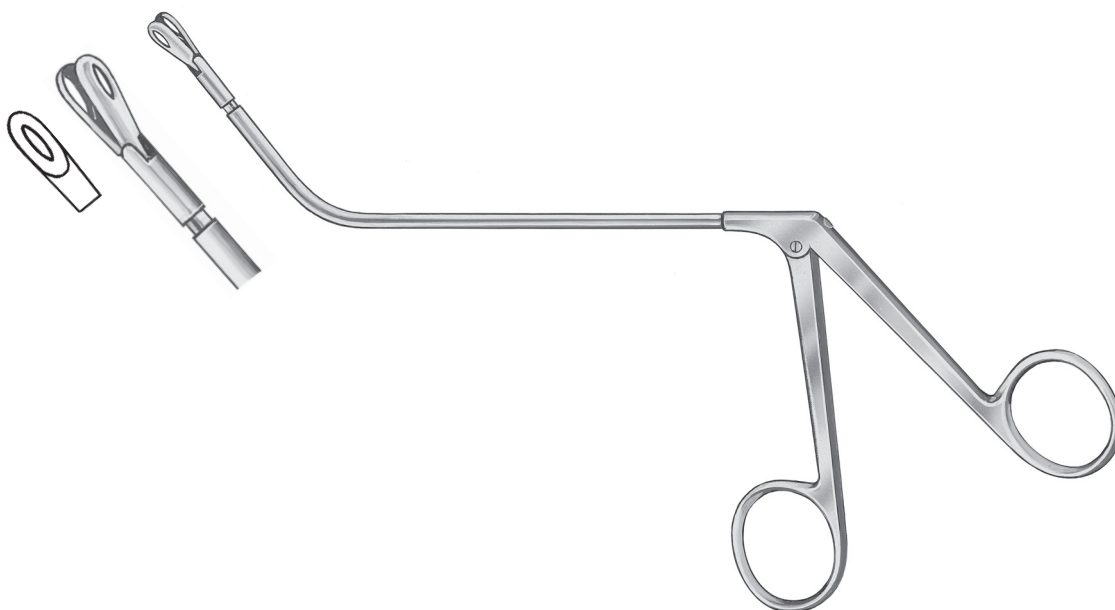

24 cm/9½"
RU 8117-24

Stirnhöhlenstanzen, Biopsie- und Fasszangen
Sinus punches, biopsy forceps, grasping forceps

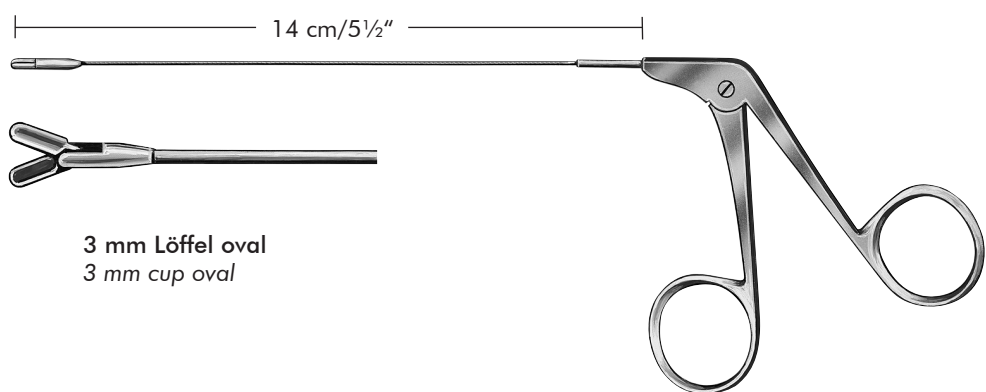
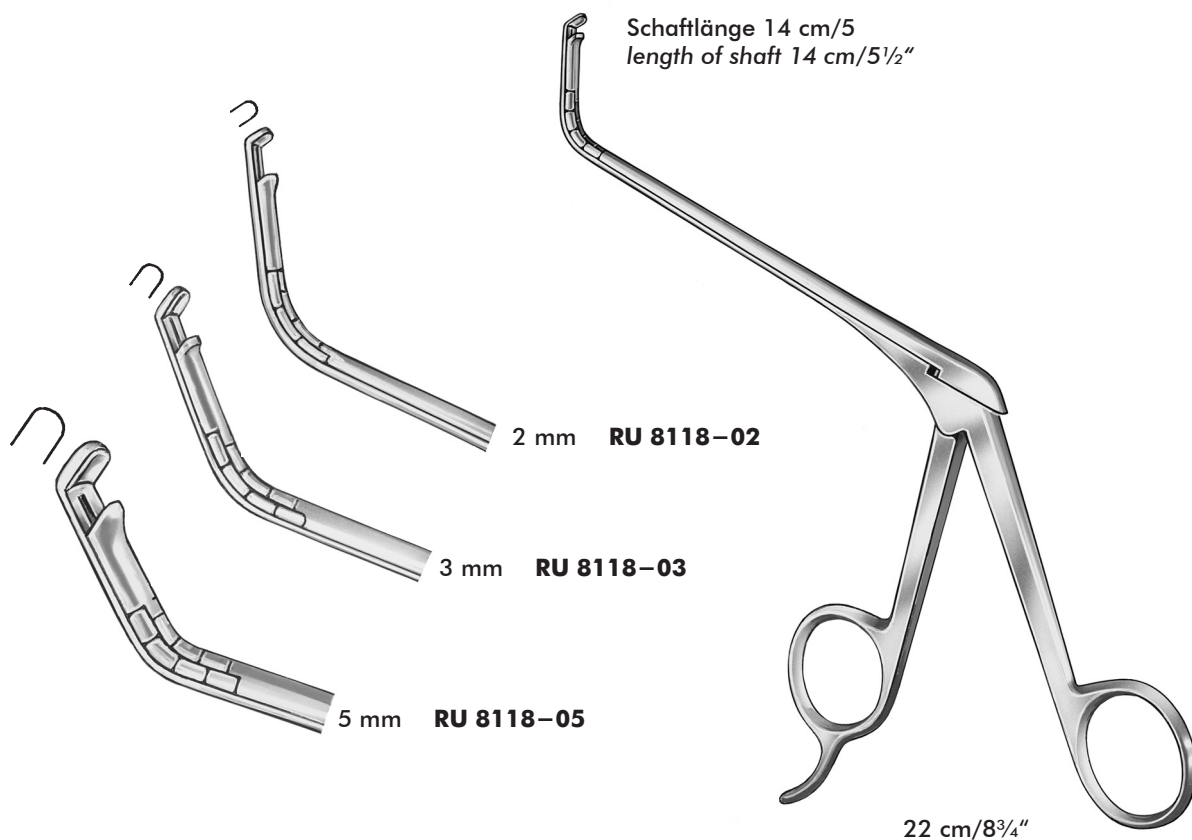

3 mm Löffel oval
3 mm cup oval

RU 8119-01

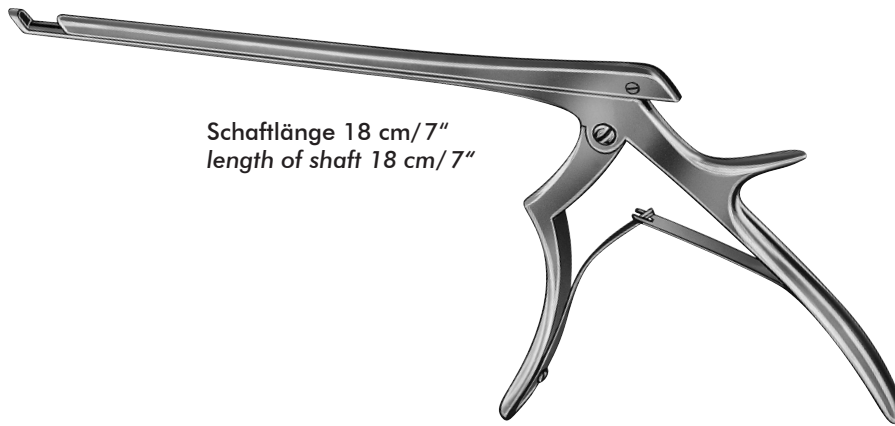

Probeexcisions- und Fasszange, extra fein
Biopsy and grasping forceps, extra fine

Kieferhöhlenstanzen
Antrum punches

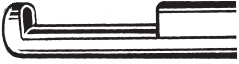

Schaftlänge 18 cm/7"
 length of shaft 18 cm/7"

Ferris-Smith-Kerrison

Bissbreite width of bite	 aufwärts schneidend 90° upwards cutting 90°	 aufwärts schneidend 40° upwards cutting 40°	 abwärts schneidend 90° downwards cutting 90°
1 mm	RU 6456-01	RU 6457-01	RU 6458-01
2 mm	RU 6456-02	RU 6457-02	RU 6458-02
3 mm	RU 6456-03	RU 6457-03	RU 6458-03
4 mm	RU 6456-04	RU 6457-04	RU 6458-04
5 mm	RU 6456-05	RU 6457-05	—



Citelli

Bissbreite/
width of bite 2,0 mm **RU 7895-20**
 3,0 mm **RU 7895-30**



Citelli-Beyer

Bissbreite/width of bite 1,5 mm
RU 7896-15

Zerlegbare Knochenstanzen Detachable bone rongeurs

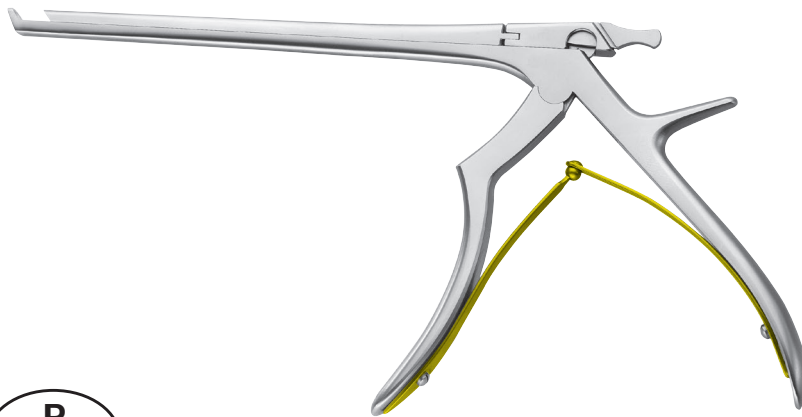

PROCLEAN

- einfache Zerlegbarkeit
- verbesserte Reinigung
- easy dismantling
- improved cleaning



Unsere zerlegbaren Kerrison-Stanzen PROCLEAN kennzeichnen sich aus durch:

- einfache Handhabung
- hohe Stanzleistung dank einzigartiger Schaffführung
- optimierte Reinigungsmöglichkeiten

Our dismantlable Kerrison punches PROCLEAN are characterised by:

- *easy handling*
- *high cutting performance thanks to the unique shaft guide*
- *improved cleaning options*



PROCLEAN zerlegbare Kerrison-Stanzen mit DLC-Keramikbeschichtung. DLC steht für eine diamantähnliche Kohlenstoffbeschichtung mit folgenden Eigenschaften:

- sehr hohe Härte ~ 1.500 HV
- kratzfest und verschleißarm
- zusätzlicher Schutz gegen korrosive Medien
- verlängerte Lebensdauer

PROCLEAN dismantlable Kerrison-punches with DLC ceramic coating. DLC stands for a diamond-like carbon coating with the following properties:

- *very high hardness ~ 1.500 HV*
- *scratch-resistant and low-wear*
- *additional protection against corrosive media*
- *extended service life*



PROCLEAN

- einfache Zerlegbarkeit
- verbesserte Reinigung
- easy dismantling
- improved cleaning



Öffnungshebel hochklappen
Lift up opening lever

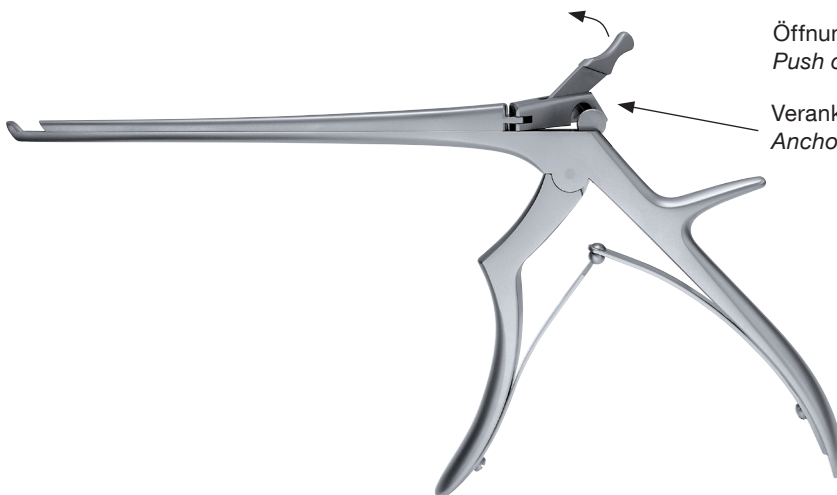

Öffnungshebel rechts wegdrücken
Push opening lever to right side

Verankerung
Anchor

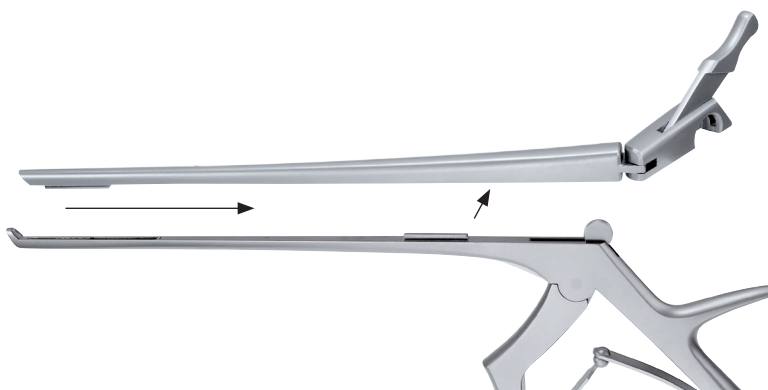

Schiebeteil abnehmen
Remove upper part

Zerlegbare Knochenstanzen

Detachable bone rongeurs



Öffnung: 10 mm
Opening: 10 mm

Flachfuß-Stanzen mit goldener Feder
Rongeurs with thin foot plate have golden springs

PROCLEAN®

- einfache Zerlegbarkeit
- verbesserte Reinigung
- easy dismantling
- improved cleaning



Flachfuß
Thin foot plate



Schaftlänge Shaft length	Maulbreite Jaw width	aufwärts schneidend 90° cutting upwards 90°	aufwärts schneidend 40° cutting upwards 40°
18 cm – 7"	1 mm	–	RU 6457-51P
	1 mm	–	RU 6457-51Z
	2 mm	RU 6456-52P	RU 6457-52P
	3 mm	RU 6456-53P	RU 6457-53P
	4 mm	RU 6456-54P	RU 6457-54P
	5 mm	RU 6456-55P	RU 6457-55P
20 cm – 8"	1 mm	–	RU 6453-51P
	1 mm	–	RU 6453-51Z
	2 mm	–	RU 6453-52P
	2 mm	–	RU 6453-52Z
	3 mm	–	RU 6453-53P
	3 mm	–	RU 6453-53Z
	5 mm	–	RU 6453-55P
	5 mm	–	RU 6453-55Z

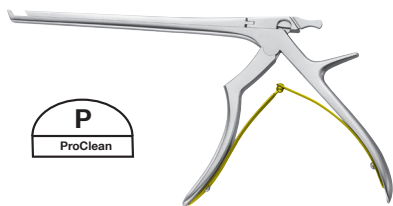

Kieferhöhlenstanzen
Antrum punches

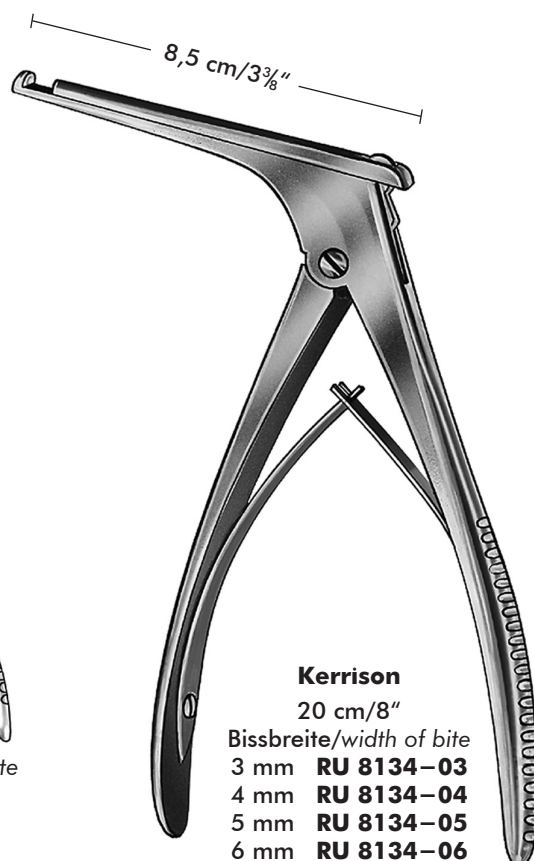
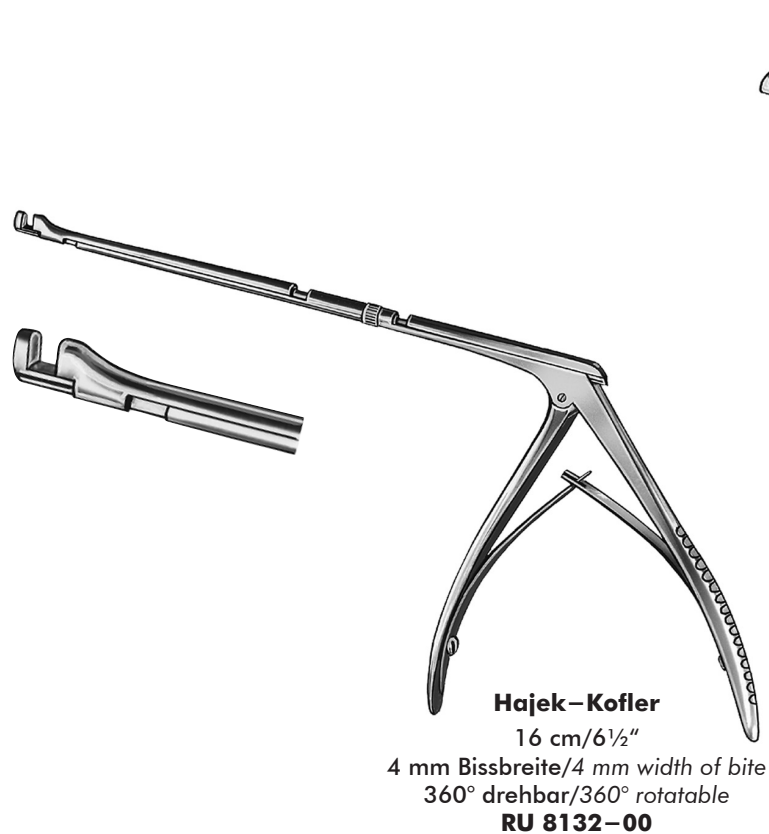
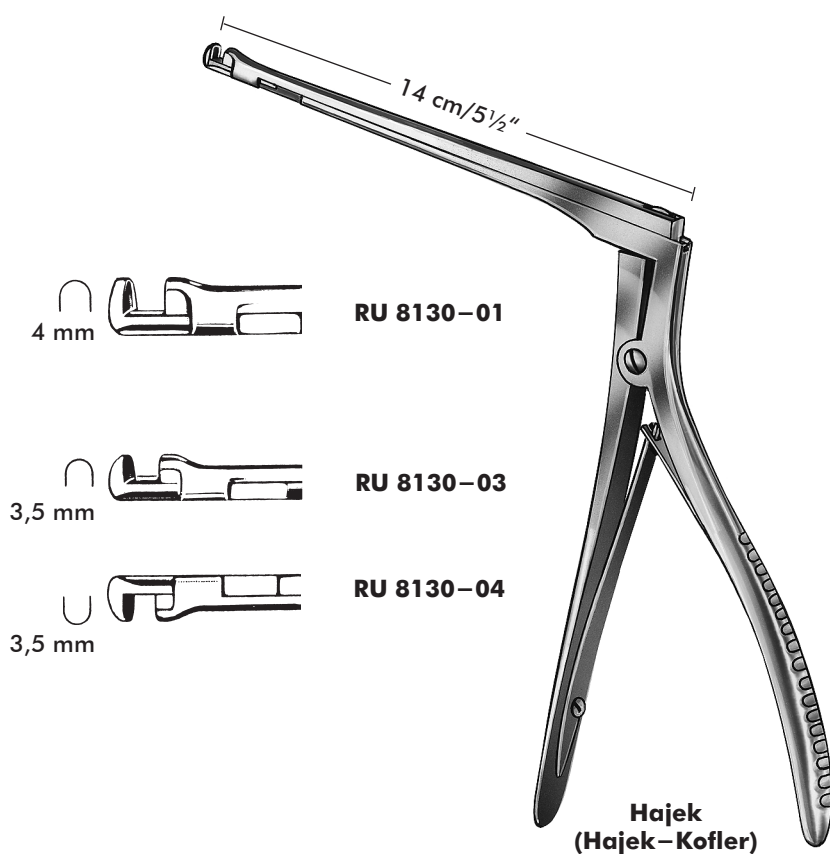

Sichelmesser, Kieferhöhlen- und Stirnhöhlen Löffel
Sickle knives, maxillary and frontal sinus curettes

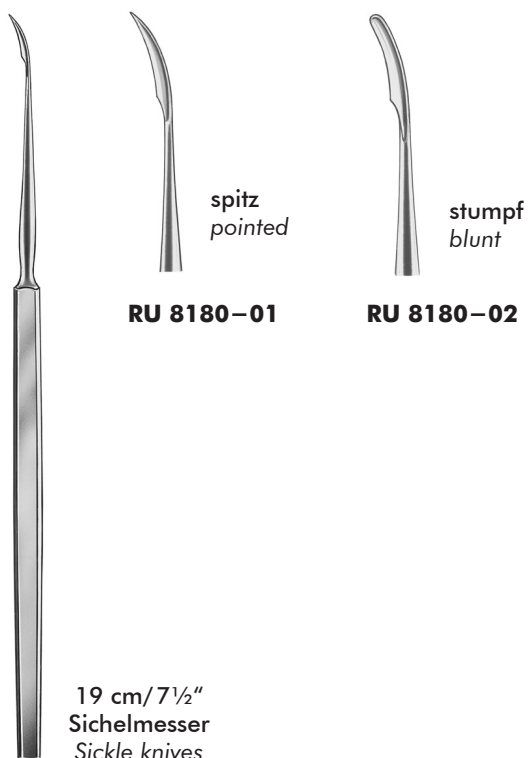

19 cm / 7½"
 Sichelmesser
 Sickle knives

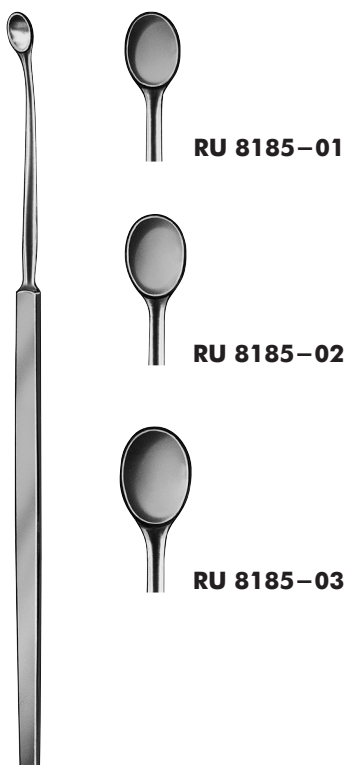

19 cm / 7½"
 Kieferhöhlen-Löffel
 Antrum curettes

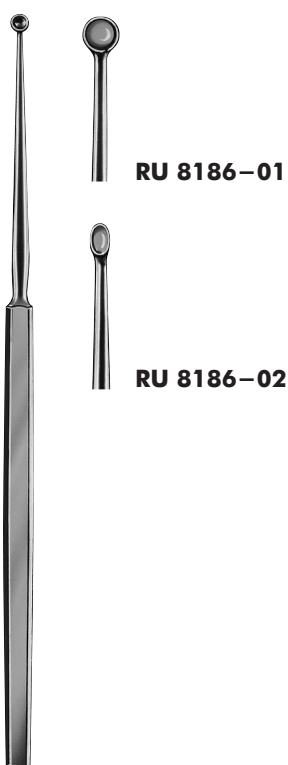

19 cm / 7½"
 Kieferhöhlen-Löffel
 Antrum curettes

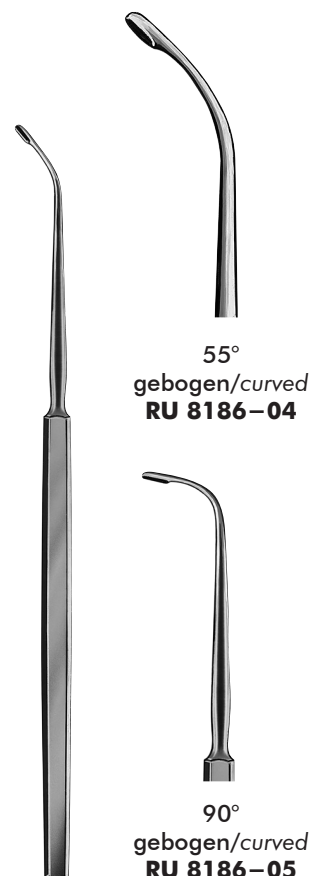

Kuhn-Bolger
 19 cm / 7½"

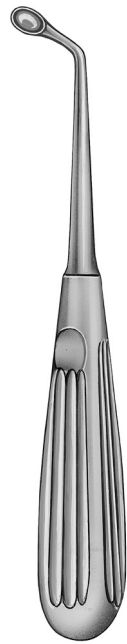

RU 5357-01

Uffenerde
17 cm/6¾"

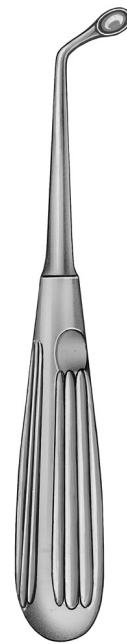

RU 5357-02

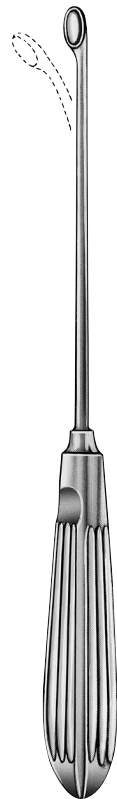

Halle
21 cm/8¼"
biegsam/flexible



Fig. 1
RU 5362-01



Fig. 2
RU 5362-02

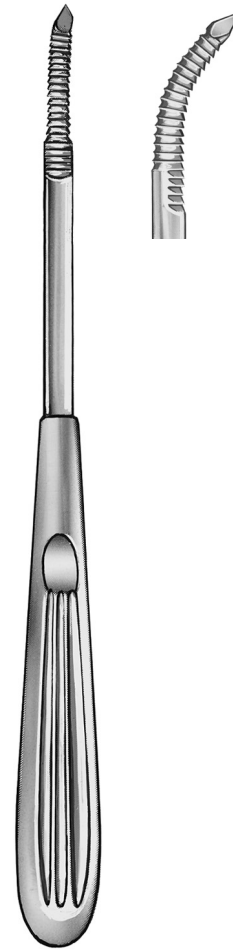

Fig. 3
RU 5362-03

Kieferhöhlenmeißel und -Raspel
Antrum chisel and rasp



Faulkner
17 cm/6³/₄"
RU 8242-01
Kieferhöhlenmeißel
Antrum chisel



Wiener
19,5 cm/7³/₄"
RU 8269-12
Kieferhöhlenraspel
Antrum rasp

Kieferhöhlen-Elevatoren und Küretten
Elevators, antrum currettes



Faulkner
 21 cm/8¼"
RU 8334-21

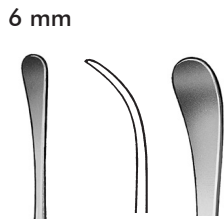

Sewall
 20 cm/8"
RU 8335-20
 Elevatorium
 Elevator



19 cm/7½"

vorwärts
 schneidend
 forwards
 cutting



RU 8338-03

rückwärts
 schneidend
 backwards
 cutting



RU 8338-04



Coakley
 17 cm/6¾"



RU 8340-01



RU 8340-02



RU 8340-03



RU 8340-04



RU 8340-05



RU 8340-06



Eicken-Killian

Ø	14,5 cm/5½"
3,0 mm	RU 8368-01

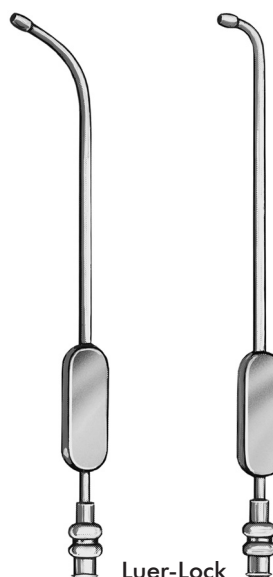

Luer-Lock

Eicken

Ø	14,5 cm/5½"	
2,5 mm	RU 8368-12	RU 8368-22
3,0 mm	RU 8368-13	RU 8368-23
4,0 mm	RU 8368-14	—



Ritter-Halle

16 cm/6¼"

2,5 mm	RU 8370-25
3,0 mm	RU 8370-30
4,0 mm	RU 8370-40
5,0 mm	RU 8370-50

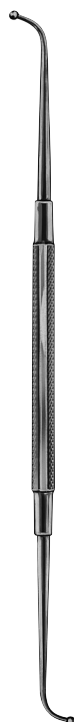

18 cm/7"
RU 8236-18

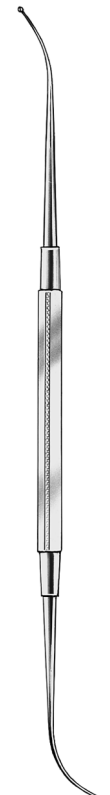

21 cm/8¼"
RU 8187-01

Doppelinstrument, gebogen,
 abgewinkelter Haken an einem Ende
*Frontal sinus ostium seeker,
 double-ended, curved*

Sinuskopie-Trokare
Sinuscopy trocars

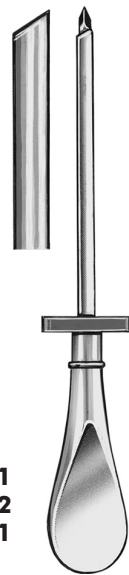

Ø 3,3 mm **RU 8370-11**
Ø 4,0 mm **RU 8370-12**
Ø 5,0 mm **RU 8370-01**

14 cm/5½"

Nutzlänge
working length
8,5 cm/3¾"



Ø 5 mm
RU 8370-02

14 cm/5½"



Tracheal-Dilatatoren, Sperrer	<i>Trachea Dilators, Retractors</i>	307
Trachealhaken, Schilddrüsenhaken, Sonde	<i>Trachea Hooks, Thyroid Gland Retractors, Probe</i>	308

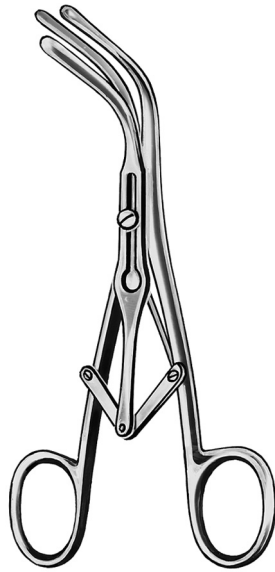

Laborde
15 cm/6"
RU 6250-15



Trousseau
14 cm/5½"
RU 6251-14



Trousseau-Baby
13 cm/5"
RU 6252-13



Bose
7 cm/2¾"
RU 6253-07

Trachealhaken, Schilddrüsenhaken, Sonde
Trachea hooks, thyroid gland retractors, probe



scharf/sharp

rechts/right
für linke Hand
for left hand

Bose
16 cm/6¼"
RU 6255-02



Schoenborn
21 cm/8¼"
RU 6257-21



Kocher

15 cm/6" **RU 6277-15**
16 cm/6¼" **RU 6277-16**



Zangen zur endolaryngealen Mikrochirurgie	<i>Forceps for Endolaryngeal Microsurgery</i>	311 — 316
Laryngoskopie - Instrumente	<i>Laryngeal Instruments</i>	317 — 318
Watteträger	<i>Cotton Applicators</i>	319
Universalgriff und Verlängerungsrohre für Zungenaufsätze	<i>Universal Handle and Tubes, for Forcepstips</i>	320
Zangenaufsätze f. Universalgriff und Verlängerungsrohre	<i>Forceps Tips for Universal Handle and Tubes</i>	321
Kehlkopfspiegel und Griffe	<i>Laryngeal Mirrors and Handles</i>	322
Kehlkopfzangen	<i>Laryngeal Forceps</i>	323 — 324
Kehldeckelhalter, Laryngofissur-Schere	<i>Epiglottis Retractor, Laryngectomy Scissors</i>	324

Zangen zur endolaryngealen Mikrochirurgie
Forceps for endolaryngeal microsurgery

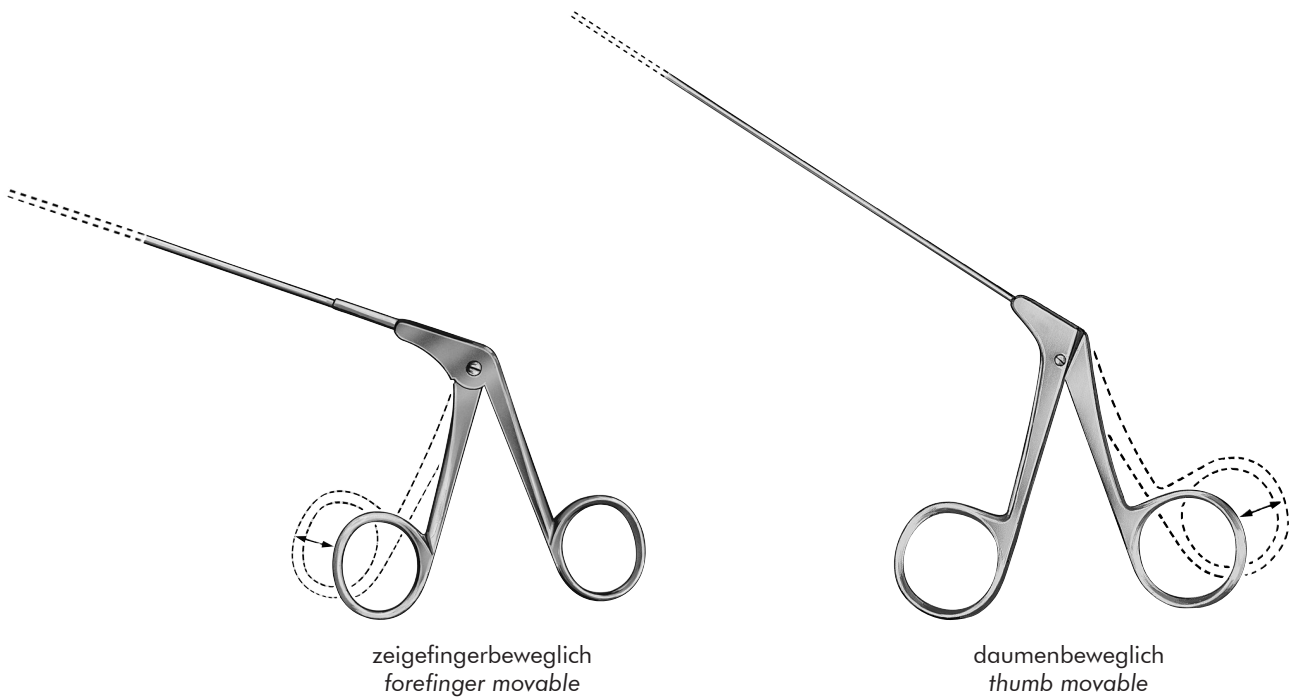



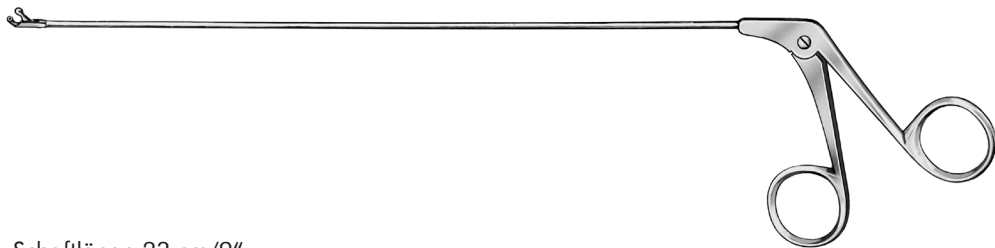

Instrumentarium zur endolaryngealen Mikrochirurgie mit konisch zulaufendem Schaft für hohe Stabilität bei gleichzeitig optimaler Sicht.

Laryngeal instruments for endolaryngeal microsurgery with conical shaft for high stability and optimal view.



Schaftlänge 23 cm/9"
 Length of shaft 23 cm/9"





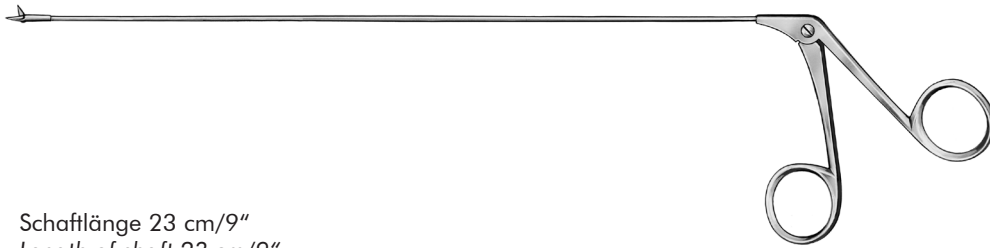

Löffelzangen, Ø 4 mm Cutting forceps, Ø 4 mm		zeigefingerbeweglich forefinger movable
	gerade straight	RU 8650-00/40
	aufwärts gebogen curved upwards	RU 8650-00/43
	rechts gebogen curved right	RU 8650-00/45
	links gebogen curved left	RU 8650-00/46

Zangen zur endolaryngealen Mikrochirurgie





Forceps for endolaryngeal microsurgery



Schaftlänge 23 cm/9"
Length of shaft 23 cm/9"

Mikroscheren, Ø 2 mm Micro scissors, Ø 2 mm	zeigefingerbeweglich forefinger movable	daumenbeweglich thumb movable
 gerade straight	RU 8650-03/01	RU 8650-04/01
 gerade horizontal straight horizontal	RU 8650-03/02	—
 45° aufgewinkelt angled up 45°	RU 8650-03/03	RU 8650-04/03
 15° aufgewinkelt angled up 15°	RU 8650-03/04	—
 rechts gebogen curved right	RU 8650-03/05	RU 8650-04/05
 links gebogen curved left	RU 8650-03/06	RU 8650-04/06

Schaftlänge 18 cm/7"
Length of shaft 18 cm/7"





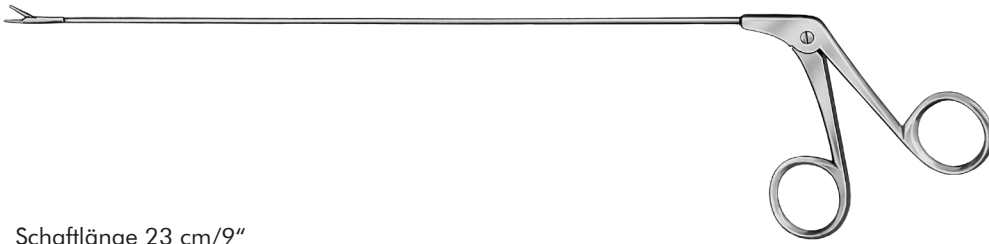

Mikroscheren, Ø 2 mm Micro scissors, Ø 2 mm	zeigefingerbeweglich forefinger movable	daumenbeweglich thumb movable
 gerade straight	RU 8649-03/01	RU 8649-04/01
 45° aufgewinkelt angled up 45°	RU 8649-03/03	—
 rechts gebogen curved right	RU 8649-03/05	RU 8649-04/05
 links gebogen curved left	RU 8649-03/06	RU 8649-04/06

Zangen zur endolaryngealen Mikrochirurgie

Forceps for endolaryngeal microsurgery



Schaftlänge 23 cm/9"
Length of shaft 23 cm/9"

Mikro-Fasszangen, Ø 2 mm Micro forceps, Ø 2 mm		zeigefingerbeweglich forefinger movable	daumenbeweglich thumb movable
	gerade straight	RU 8650-03/11	—
	aufwärts gebogen curved upwards	RU 8650-03/13	—
	rechts gebogen curved right	RU 8650-03/15	RU 8650-04/15
	links gebogen curved left	RU 8650-03/16	RU 8650-04/16
	aufwärts gebogen rechts curved upwards right	RU 8650-03/18	RU 8650-04/18
	aufwärts gebogen links curved upwards left	RU 8650-03/19	RU 8650-04/19







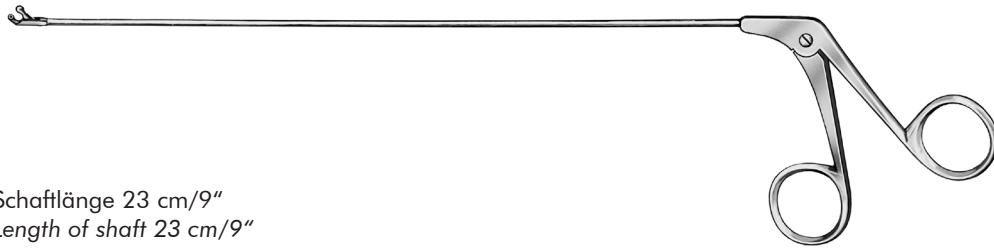

Schaftlänge 18 cm/7"
Length of shaft 18 cm/7"

Mikro-Fasszangen, Ø 2 mm Micro forceps, Ø 2 mm		zeigefingerbeweglich forefinger movable	daumenbeweglich thumb movable
	gerade straight	RU 8649-03/11	RU 8649-04/11

Zangen zur endolaryngealen Mikrochirurgie Forceps for endolaryngeal microsurgery

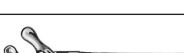

Schaftlänge 23 cm/9"
Length of shaft 23 cm/9"

Mikro-Löffelzangen, Ø 2 mm Micro cutting forceps, Ø 2 mm		zeigefingerbeweglich forefinger movable	daumenbeweglich thumb movable
 gerade straight		RU 8650-03/21	RU 8650-04/21
 aufwärts gebogen curved upwards		RU 8650-03/23	RU 8650-04/23
 rechts gebogen curved right		RU 8650-03/25	RU 8650-04/25
 links gebogen curved left		RU 8650-03/26	RU 8650-04/26
 aufwärts gebogen rechts curved upwards right		RU 8650-03/30	—
 aufwärts gebogen links curved upwards left		RU 8650-03/31	—
 horizontal rechts horizontal right		RU 8650-03/32	RU 8650-04/32
 horizontal links horizontal left		RU 8650-03/33	RU 8650-04/33

Schaftlänge 18 cm/7"
Length of shaft 18 cm/7"

Mikro-Löffelzangen, Ø 2 mm Micro cutting forceps, Ø 2 mm		zeigefingerbeweglich forefinger movable	daumenbeweglich thumb movable
 gerade straight		—	RU 8649-04/21
 aufwärts gebogen curved upwards		RU 8649-03/23	—

Schaftlänge 18 cm/7"
Length of shaft 18 cm/7"

Mikro-Löffelzangen, Ø 3 mm Micro cutting forceps, Ø 3 mm		zeigefingerbeweglich forefinger movable
 aufwärts gebogen curved upwards		RU 8649-05/23

Zangen zur endolaryngealen Mikrochirurgie

Forceps for endolaryngeal microsurgery



Schaftlänge 23 cm/9"
Length of shaft 23 cm/9"

Mikro-Scheren, Ø 1 mm Micro scissors, Ø 1 mm	zeigefingerbeweglich forefinger movable	daumenbeweglich thumb movable
 gerade straight	RU 8650-11/01	—
 abgewinkelt 45° angled 45°	—	RU 8650-12/03
 rechts gebogen curved right	RU 8650-11/05	—
 links gebogen curved left	RU 8650-11/06	—







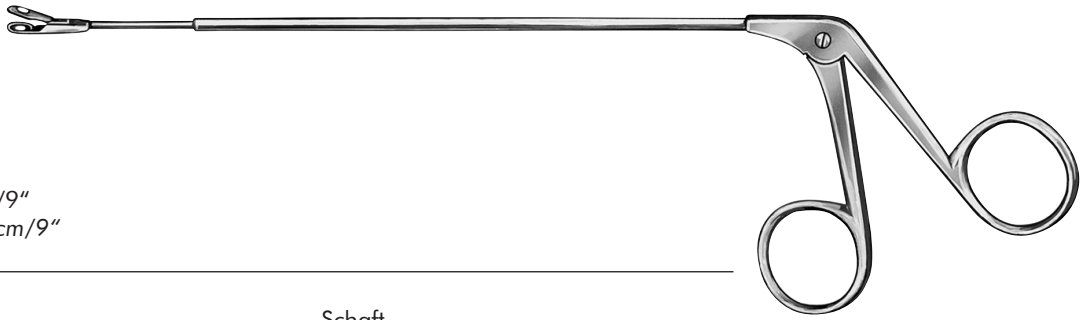

Mikro-Fasszangen, Ø 1 mm Micro forceps, Ø 1 mm	zeigefingerbeweglich forefinger movable	daumenbeweglich thumb movable
 gerade straight	RU 8650-11/11	—
 aufwärts gebogen curved upwards	RU 8650-11/13	—
 rechts gebogen curved right	RU 8650-11/15	—
 links gebogen curved left	RU 8650-11/16	RU 8650-12/16

Mikro-Löffelzangen, Ø 1 mm Micro cutting forceps, Ø 1 mm	zeigefingerbeweglich forefinger movable	daumenbeweglich thumb movable
 gerade straight	RU 8650-11/21	RU 8650-12/21
 aufwärts gebogen curved upwards	RU 8650-11/23	RU 8650-12/23
 rechts gebogen curved right	RU 8650-11/25	—

Zangen zur endolaryngealen Mikrochirurgie
Forceps for endolaryngeal microsurgery



Schaftlänge 23 cm/9"
 Length of shaft 23 cm/9"

		Schaft shaft	
RU 8651-01		Ø 2,5 mm	Zängchen mit gefenesterten Maulteilen scharf, gerade <i>Cutting forceps, with fenestrated jaw, sharp, straight</i>
RU 8651-02		Ø 2,0 mm	Zängchen mit ovalem Löffel 2 x 3 mm, gerade <i>Cup-shaped forceps, oval 2 x 3 mm, straight</i>
RU 8651-05		Ø 3,0 mm	Zängchen zur Probeexzision, 4 x 4,5 mm, 90° gewinkelt <i>Biopsy punch, 4 x 4,5 mm, 90° angled</i>
RU 8651-10		Ø 2,5 mm	Fasszange, kräftiges Modell <i>Grasping forceps, strong</i>
RU 8651-11		Ø 2,5 mm	Zange mit Hechtmaul <i>Alligator grasping forceps</i>
RU 8651-20		Ø 2,7 mm	Zange mit ovalem Löffel, kräftig <i>Forceps, oval, strong</i>
RU 8651-21		Ø 2,5 mm	Zange mit Löffel 4 mm, kräftig <i>Forceps, strong</i>
RU 8651-40			Nadelhalter mit Sperre <i>Needleholder with ratchet</i>

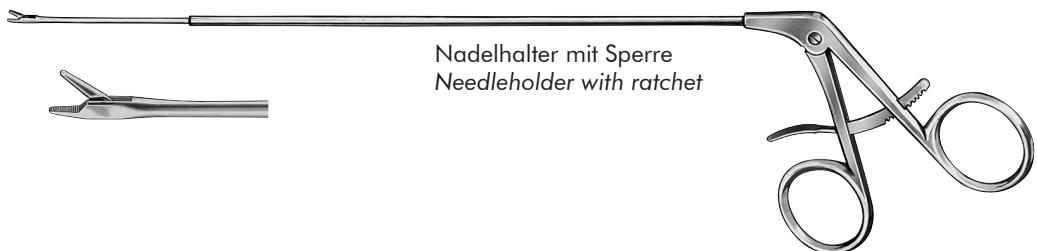

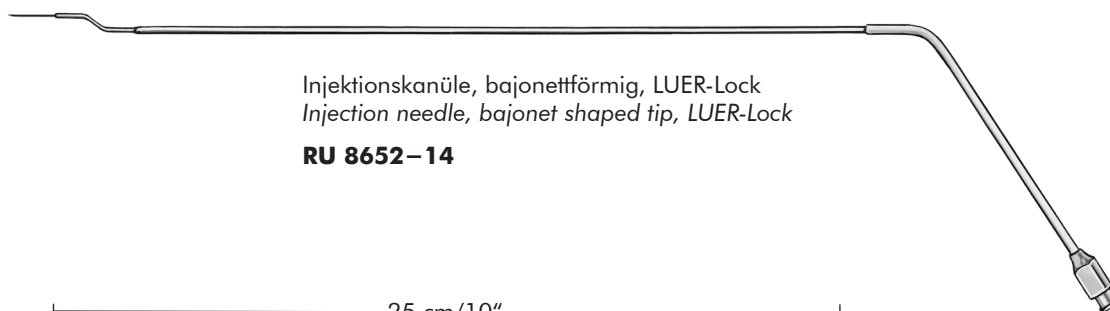

Injektionskanüle, bajonettförmig, LUER-Lock
Injection needle, bayonet shaped tip, LUER-Lock

RU 8652-14

25 cm/10"

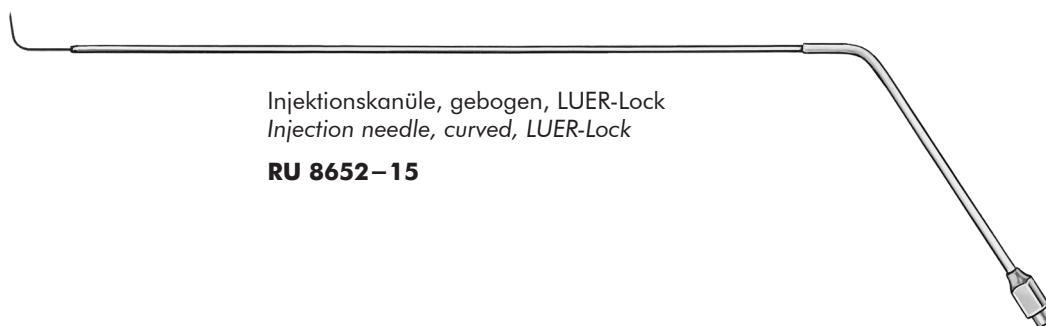

Injektionskanüle, gebogen, LUER-Lock
Injection needle, curved, LUER-Lock

RU 8652-15

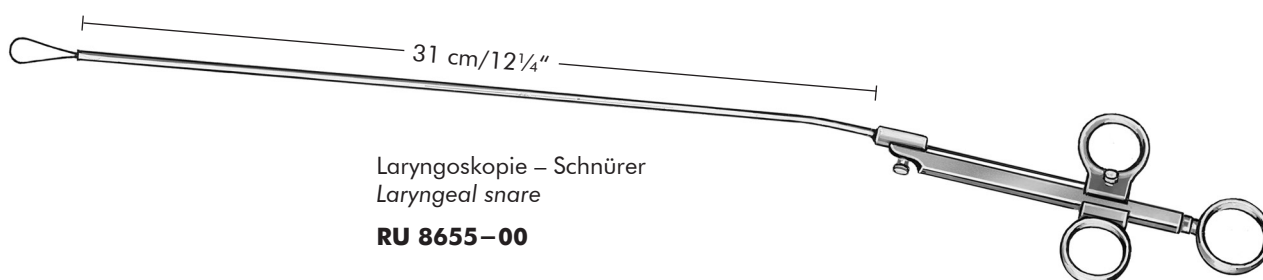

31 cm/12 1/4"

Laryngoskopie – Schnürer
Laryngeal snare

RU 8655-00

Schnürerdraht
Snare wire



0,3 mm

Packung à 12 Stück
Package of 1 dozen each

RU 8024-10

0,3 mm

Packung à 100 Stück
Package of 100 pieces

RU 8024-10/00

Handgriff für Stabinstrumente
Handle for instruments

RU 8652-00

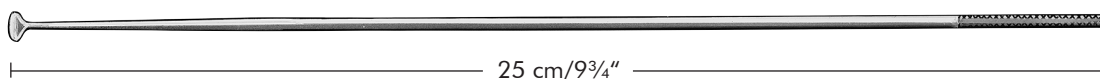
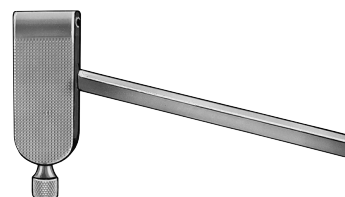

RU 8652-21
Messer, oval, gerade
Knife, oval, straight



RU 8652-28
Häkchen, scharf
Hook, sharp



RU 8652-22
Messer, 45°
Knife, 45°



RU 8652-29
Häkchen, 90°, mit Sondenknopf
Hook, with probe end, angled 90°



RU 8652-23
Messer, gebogen, spitz
Knife, curved, pointed



RU 8652-30
Nadel, rechts gebogen
Needle, curved right



RU 8652-24
Messer, gerade, spitz
Knife, straight, pointed



RU 8652-31
Nadel, links gebogen
Needle, curved left



RU 8652-25
Messer, rund, gebogen
Knife, round, curved



RU 8652-32
Saug- Raspatorium
Suction raspatorium



RU 8652-26
Messer, rund, vertikal
Knife, round, vertical cutting



RU 8652-33
Fadengabel
Knot tier



RU 8652-27
Häkchen, stumpf, mit Sondenknopf
Hook, blunt, with probe end



RU 8652-34
Messer, längs, oval
Knife, vertical, oval blade



RU 8652-35
Messer, 45° abgewinkelt
Knife, 45° angled

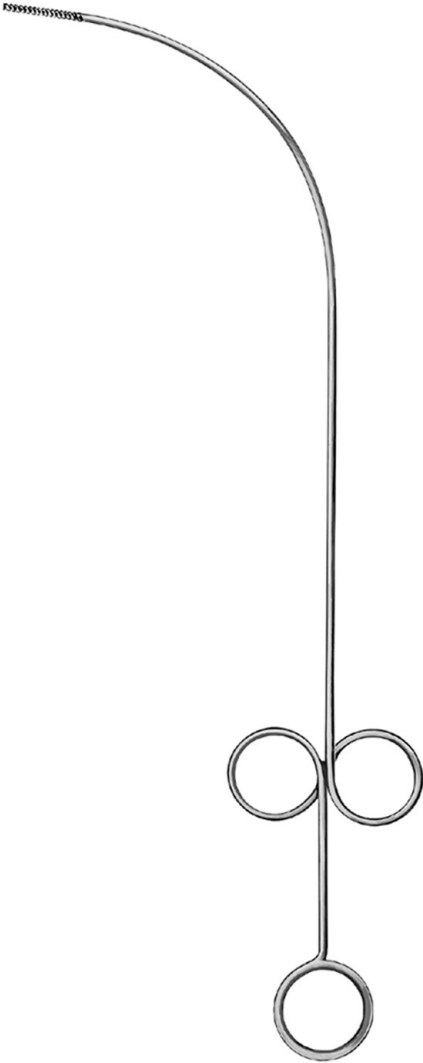

Fein
28 cm/11"
RU 4922-28

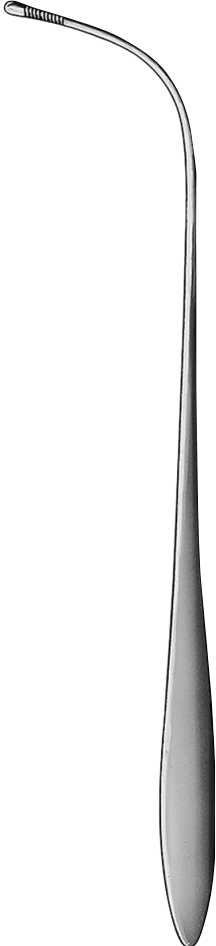

Killian
25 cm/10"
RU 4922-50

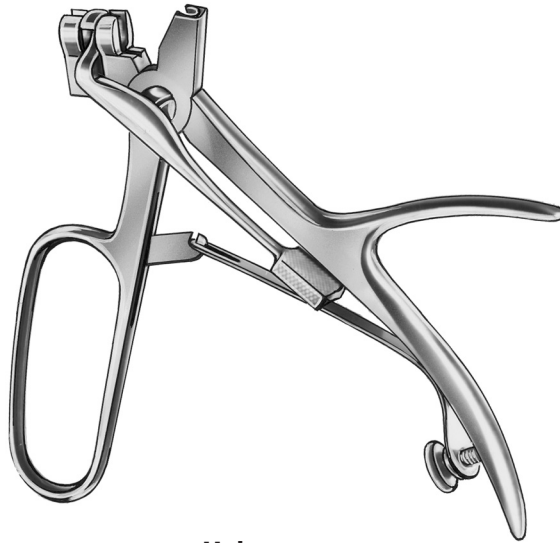

Huber
RU 8630-00



Verlängerungsrohr, gerade
tube, straight

20 cm/8"
30 cm/12"

RU 8632-20
RU 8632-30

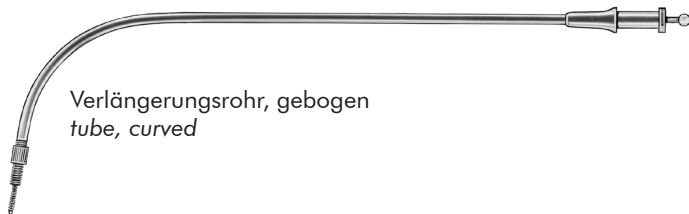

Verlängerungsrohr, gebogen
tube, curved

20 cm/8"

RU 8634-20

Zangenaufsätze für UNIVERSAL-Griff und Verlängerungsrohre
Forceps tips for UNIVERSAL-handle and tubes



Fränkel
RU 8637-01



Bruenings
 ○ 3 mm Ø **RU 8639-02**



Bruenings
 aufgewinkelt/angled up

- 2 mm **RU 8639-03**
- 3 mm **RU 8639-03/03**
- 4 mm **RU 8639-03/04**



Bruenings

- **RU 8639-04**
- **RU 8639-04/03**



Schumacher
RU 8644-01



Cordes
 **RU 8645-01**



Fränkel
RU 8648-01

Kehlkopfspiegel und Griffe
Laryngeal mirrors and handles

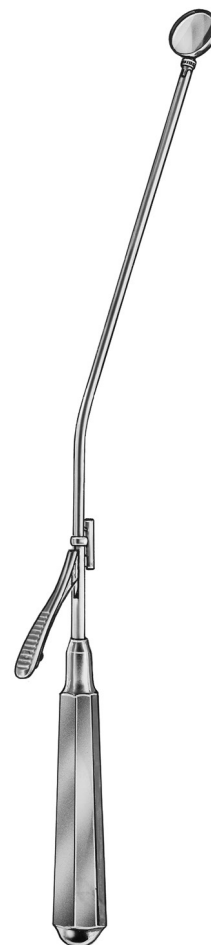

Fig. Ø

RU 8660-08	00	8 mm
RU 8660-10	0	10 mm
RU 8660-12	1	12 mm
RU 8660-14	2	14 mm
RU 8660-16	3	16 mm
RU 8660-18	4	18 mm
RU 8660-20	5	20 mm
RU 8660-22	6	22 mm
RU 8660-24	7	24 mm
RU 8660-26	8	26 mm
RU 8660-28	9	28 mm
RU 8660-30	10	30 mm

RU 8662-08
RU 8662-10
RU 8662-12
RU 8662-14
RU 8662-16
RU 8662-18
RU 8662-20
RU 8662-22
RU 8662-24
RU 8662-26
RU 8662-28
RU 8662-30

Michel
 25 cm/10"

Ø	kpl./cpl.
12 mm	RU 8664-12
16 mm	RU 8664-16
18 mm	RU 8664-18



Spiegelgriffe
Mirror handles



11 cm/4³/₈"
RU 8666-01

10,5 cm/4¹/₈"
RU 8666-02

Kehlkopfzangen
Laryngeal forceps

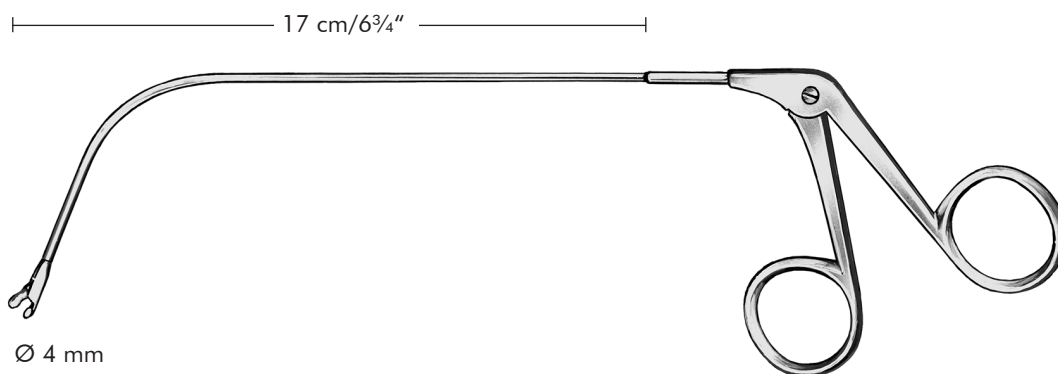

Ø 4 mm



RU 8688-01

gerade/straight



RU 8688-03

rechts gebogen/curved right



RU 8688-04

links gebogen/curved left

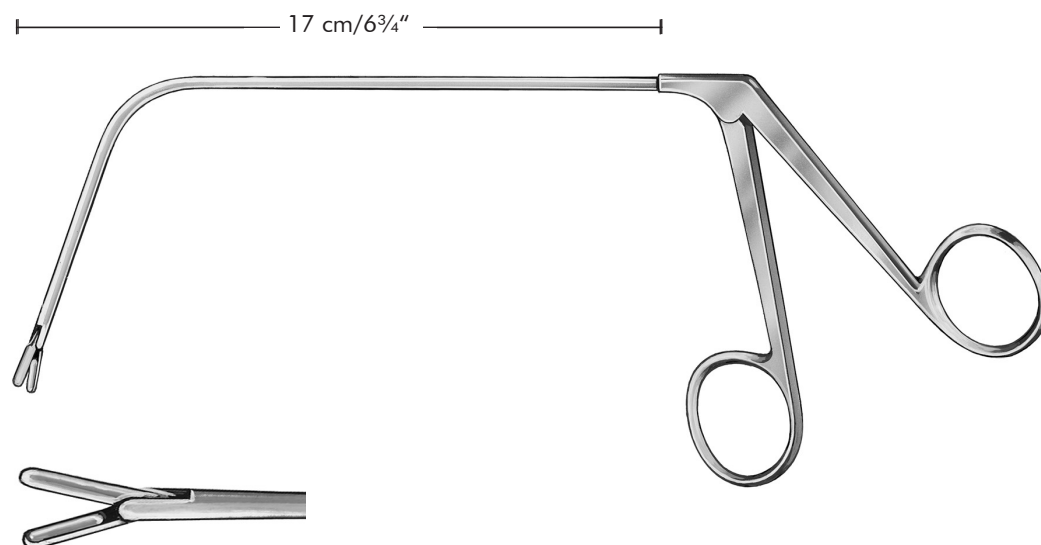

Fraenkel

25 cm/10"

RU 8689-01

Kehlkopf-Fremdkörperzange
Laryngeal polypus forceps

Kehlkopfzangen, Kehldeckelhalter, Laryngofissurschere
Laryngeal Forceps, epiglottis retractor, laryngectomy scissors

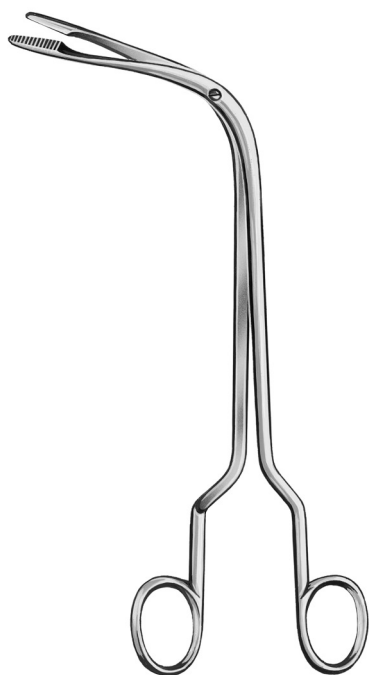

Fraenkel
18 cm/7"
RU 8680-18

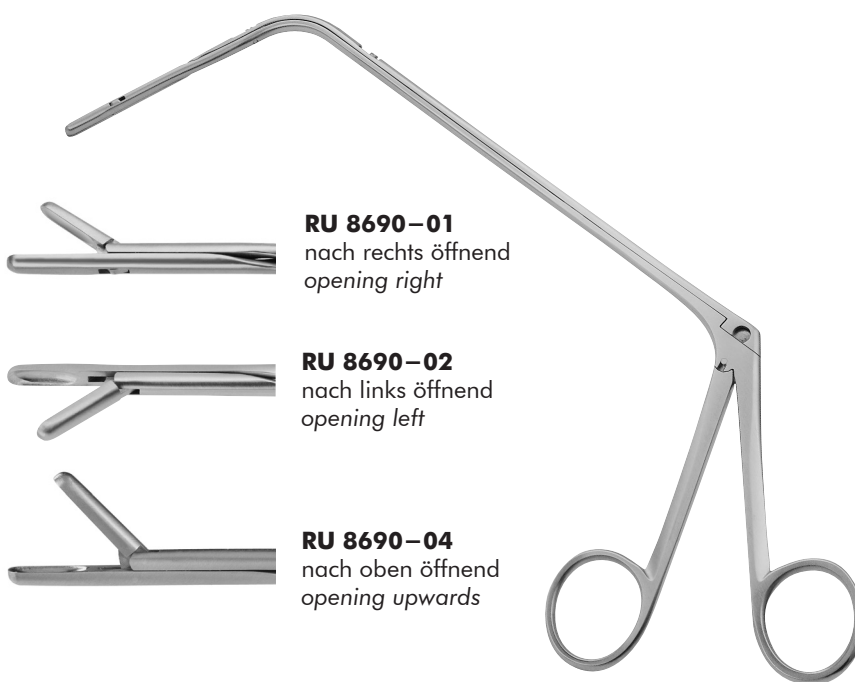

RU 8690-01
nach rechts öffnend
opening right

RU 8690-02
nach links öffnend
opening left

RU 8690-04
nach oben öffnend
opening upwards

Jurasz
23 cm/9"



Reichert
24 cm/9½"
RU 8692-24



Killian
20 cm/8"
RU 8695-20

KAPITEL 10 – Bronchoskopie und Oesophagoskopie
CHAPTER 10 – Bronchoscopy and Oesophagoscopy



Seite / Page

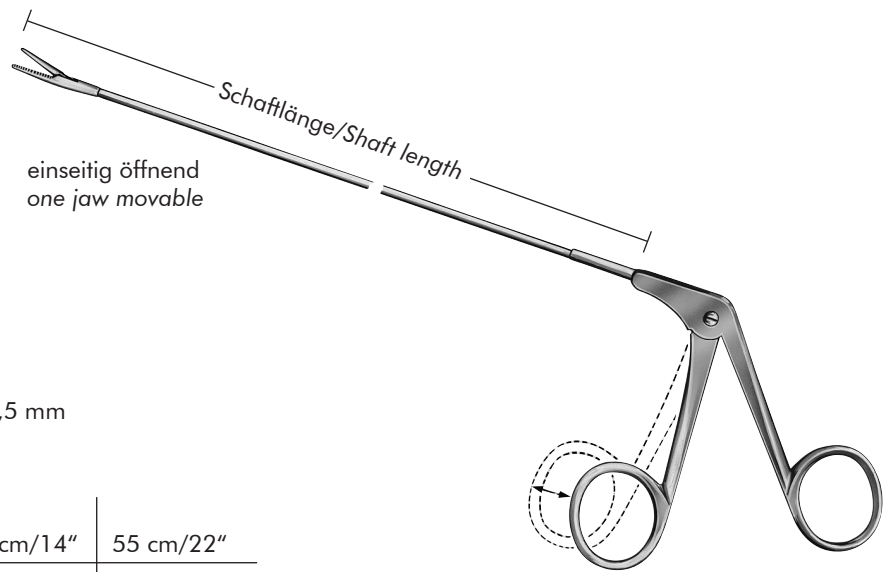

Zangen für Laryngo - Broncho - Oesophagoskopie	<i>Forceps for Laryngo - Broncho - Esophagoscopy</i>	327
Broncho - Oesophagoskopiezangen	<i>Broncho - Esophagoscopy Forceps</i>	328

Zangen für Laryngo-Broncho-Oesophagoskopie
Forceps for laryngo-broncho-esophagoscopy



für Erwachsene
 for adults

Rohrschaft/tube shaft Ø 2,5 mm

Schaftlänge length of shaft	35 cm/14"	55 cm/22"
	RU 8619-22/35	—
	RU 8619-23/35	RU 8619-23/55
	—	RU 8619-30/55

Rohrschaft/tube shaft Ø 2,5 mm

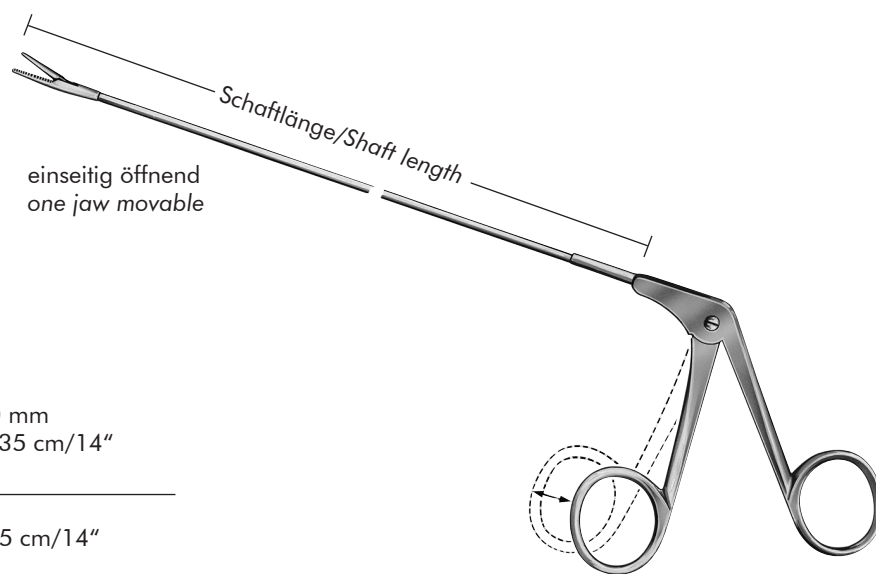

für Kinder
 for children

Rohrschaft/tube shaft Ø 2,0 mm
 Schaftlänge/length of shaft 35 cm/14"

Schaftlänge length of shaft	35 cm/14"
	RU 8619-05/35

Rohrschaft/tube shaft Ø 2,0 mm

Zangen für Bronchoskope und Oesophagoskope

Bronchoscopic and esophagoscopic forceps

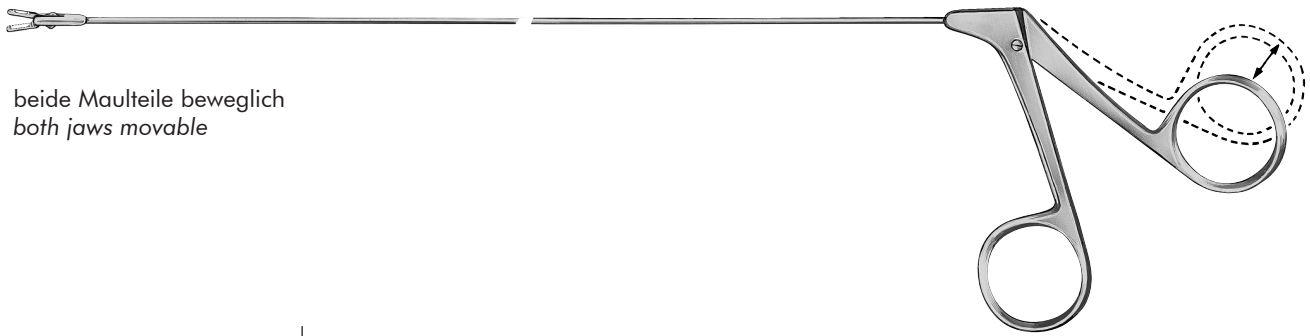

beide Maulteile beweglich
both jaws movable

	Nutzlänge/Working length Schaftstärke/Shaft diam. Ø		
	25 cm/10" Ø 1,5 mm	35 cm/14" Ø 2,0 mm	45 cm/18" Ø 2,0 mm
	RU 8619-70/01	RU 8619-72/01	—
	RU 8619-70/03	RU 8619-72/03	—
	—	—	RU 8619-73/04

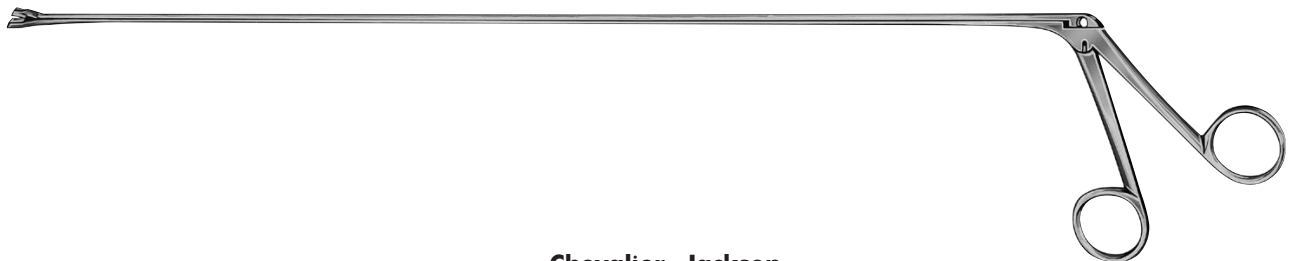

Chevalier-Jackson

Länge Length				
30 cm/12"	—	RU 8621-30	RU 8622-30	RU 8623-30
40 cm/16"	RU 8620-40	RU 8621-40	—	RU 8623-40
50 cm/20"	RU 8620-50	—	RU 8622-50	—
60 cm/24"	—	—	RU 8622-60	RU 8623-60

4 mm

Länge Length		
40 cm/16"	RU 8625-40	RU 8626-40
50 cm/20"	—	RU 8626-50

4 mm



Sterilisations-Zubehör für Endoskope	<i>Sterilization Accessories for Endoscopes</i>	331
Siebkörbe, für Container - 1/2 Größe	<i>Baskets, for Containers - Half Size</i>	332
Siebkörbe, für Container - 3/4 Größe	<i>Baskets, for Containers - Medium Size</i>	333
Siebkörbe, für Container - 1/1 Größe	<i>Baskets, for Containers - Full Size</i>	334
Siebkörbe, für MINI Container	<i>Baskets, for MINI Containers</i>	335
Minikörbe	<i>Minibaskets</i>	336
Zubehör, Pflegeprodukte	<i>Accessories, Maintenance products</i>	337
Nadeldosen, Nierenschalen, Behälter	<i>Needle Cases, Kidney Bowls, Receptacles</i>	338



autoklavierbar/*autoclavable*
max. 134°C, 2,3 bar



Schutzhülse für Endoskope bis Ø 5 mm
Protection shield for endoscopes up to Ø 5 mm
RZ010-000

Endoskopsiebkorb
Wire basket for endoscopes

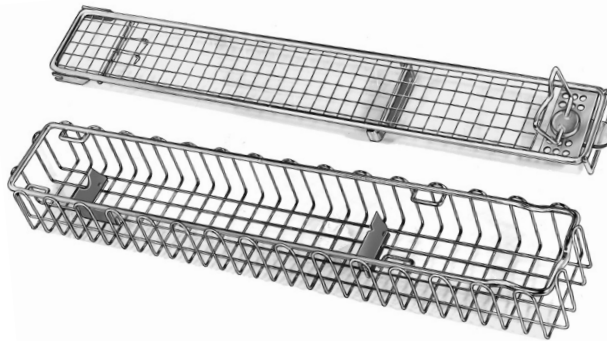

290 x 80 x 52 mm
RU 8908-01

460 x 80 x 52 mm
RU 8908-11

670 x 80 x 52 mm
RU 8908-02

Kunststoffbehälter für Endoskope
Plastic container for endoscopes

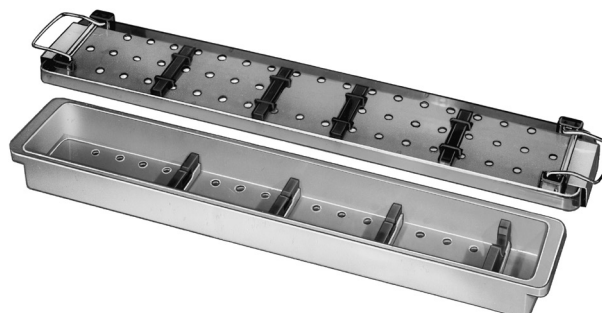

500 x 80 x 40 mm
RU 8908-12

Siebkörbe für Container 1/2 Größe
Baskets for Containers Half Size



Deckel für Drahtsiebkorb
Lid for wire basket

230 x 235 mm **CS140-000**

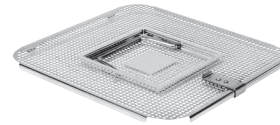

Deckel für Siebkorb
Lid for perforated basket

240 x 240 mm **CS141-000**



Drahtsiebkorb
Wire basket

255 x 245 x 30 mm **CS140-030**

255 x 245 x 50 mm **CS140-050**

255 x 245 x 70 mm **CS140-070**

255 x 245 x 100 mm **CS140-100**

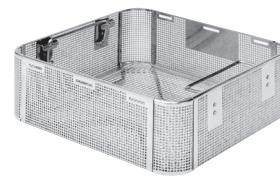

Siebkorb
Perforated basket

240 x 240 x 41 mm **CS141-041**

240 x 240 x 45 mm **CS141-045**

240 x 240 x 50 mm **CS141-050**

240 x 240 x 70 mm **CS141-070**

240 x 240 x 90 mm **CS141-090**

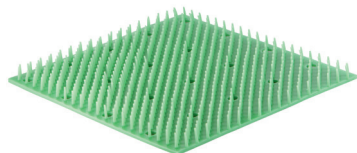

Silikon-Noppenmatte für
 Drahtsiebkorb und Siebkorb
Silicone stud mat for baskets

240 x 220 mm **CS147-001**

Siebkörbe für Container 3/4 Größe
Baskets for Containers Medium Size

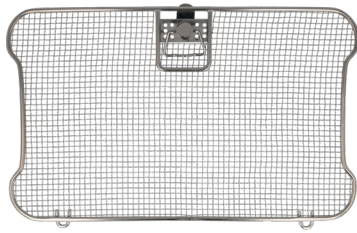

Deckel für Drahtsiebkorb
Lid for wire basket

385 x 235 mm **CS240-000**

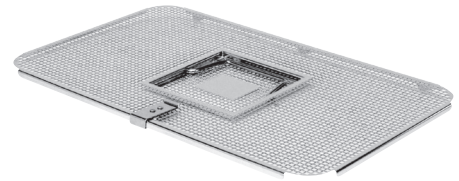

Deckel für Siebkorb
Lid for perforated basket

380 x 240 mm **CS241-000**

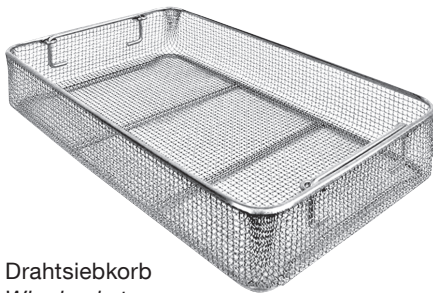

Drahtsiebkorb
Wire basket

405 x 255 x 30 mm **CS240-030**

405 x 255 x 50 mm **CS240-050**

405 x 255 x 70 mm **CS240-070**

405 x 255 x 100 mm **CS240-100**



Siebkorb
Perforated basket

380 x 240 x 50 mm **CS241-050**

380 x 240 x 70 mm **CS241-070**

380 x 240 x 90 mm **CS241-090**

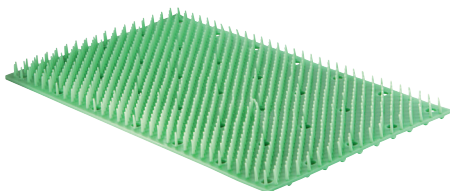

Silikon-Noppenmatte für
 Drahtsiebkorb und Siebkorb
*Silicone stud mat for
 wire basket and perforated basket*

380 x 220 mm **CS247-000**

Siebkörbe für Container I/I Größe Baskets for Containers Full Size

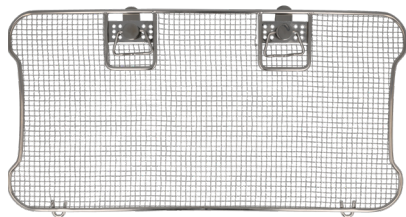

Deckel für Drahtsiebkorb
Lid for wire basket

460 x 225 mm **CS340-000**

520 x 235 mm **CS341-000**

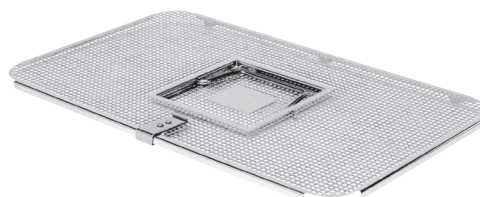

Deckel für Siebkorb
Lid for perforated basket

480 x 240 mm **CS342-000**

510 x 240 mm **CS343-000**

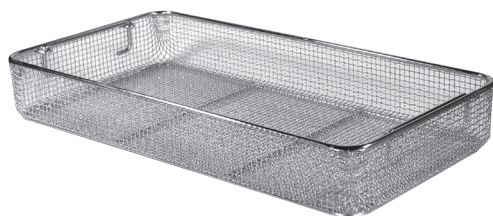

Drahtsiebkorb
Wire basket

485 x 255 x 30 mm **CS340-030**

485 x 255 x 50 mm **CS340-050**

485 x 255 x 70 mm **CS340-070**

485 x 255 x 100 mm **CS340-100**

540 x 255 x 30 mm **CS341-030**

540 x 255 x 50 mm **CS341-050**

540 x 255 x 70 mm **CS341-070**

540 x 255 x 100 mm **CS341-100**

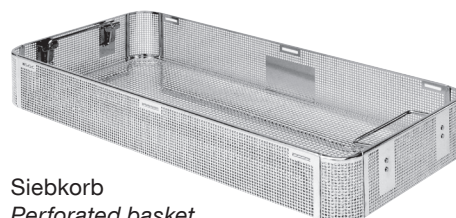

Siebkorb
Perforated basket

480 x 240 x 45 mm **CS342-045**

480 x 240 x 50 mm **CS342-050**

480 x 240 x 70 mm **CS342-070**

480 x 240 x 90 mm **CS342-090**

540 x 240 x 50 mm **CS343-050**

540 x 240 x 70 mm **CS343-070**

540 x 240 x 90 mm **CS343-090**

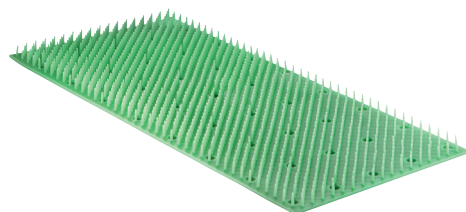

Silikon-Noppenmatte für
Drahtsiebkorb und Siebkorb
*Silicone stud mat for
wire basket and perforated basket*

480 x 220 mm **CS347-000**

500 x 220 mm **CS348-000**

Siebkörbe für MINI Container
Baskets for MINI Containers



Drahtsiebkorb
Wire basket

265 x 125 x 45 mm **CS540-045**

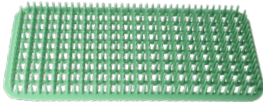

Silikon-Noppenmatte für
Drahtsiebkorb und Siebkorb
*Silicone stud mat for
wire basket and perforated basket*

257 x 123 mm **CS547-000**

Minikörbe
Minibaskets

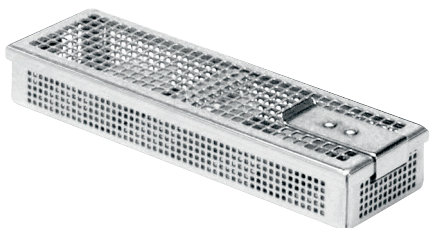

Minikorb mit Deckel
Mini basket with lid

2 Instrumentenhalter im Deckel
Silikon-Noppenmatte im Körper
2 Instrument holders in the lid
Silicone mat in the basket

170 x 50 x 30 mm **CS050-002**

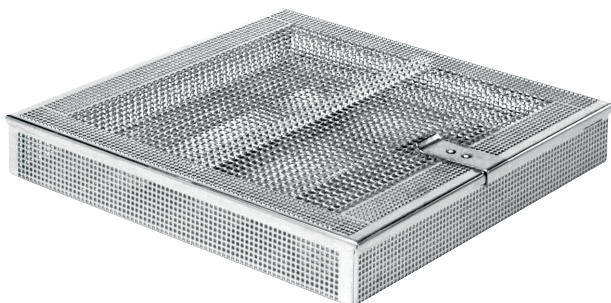

Minikorb mit Deckel
Mini basket with lid

1 Instrumentenhalter im Deckel
2 Instrumentenhalter im Körper
1 Instrument holder in the lid
2 Instrument holders in the basket

240 x 240 x 35 mm **CS050-005**

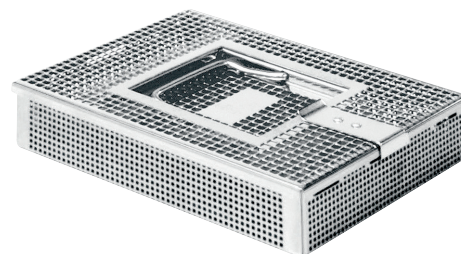

Minikorb mit Deckel
Mini basket with lid

1 Instrumentenhalter im Deckel
Silikon-Noppenmatte im Körper
1 Instrument holder in the lid
Silicone mat in the basket

135 x 170 x 35 mm **CS050-003**

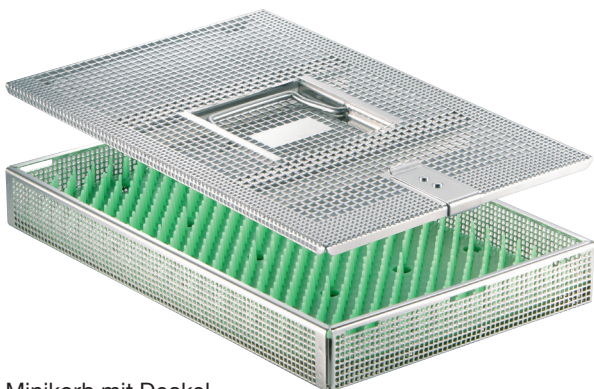

Minikorb mit Deckel
Mini basket with lid

2 Instrumentenhalter im Deckel
Silikon-Noppenmatte im Körper
2 Instrument holders in the lid
Silicone mat in the basket

270 x 170 x 35 mm **CS050-004**

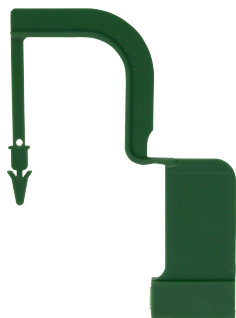

Verschlussplombe
Seal

1000 Stück / Packung
1000 pieces / package

CS950-028



Entsorgungsmarke
 für Drahtsiebkörbe
*Metal label for
 wire basket*

unbeschriftet
unlabeled

CS961-020



Entsorgungsmarke
 für Drahtsiebkörbe
*Metal label for
 wire basket*

beschriftet
labeled

CS961-021



Karabinerhaken
Carabiner

RU 8906-01



Edelstahlplakette
 Ø 25 mm
*Stainless steel tag
 Ø 25 mm*

CS961-030



Sortierspieß
Holding pin

CS956-001



Tuchklammer
Drape clamp

CS961-010

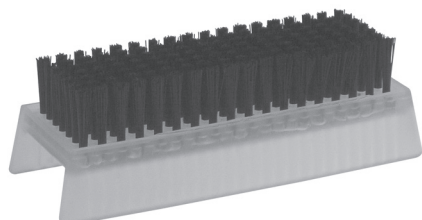

RU 8865-00

Handwaschbürsten
 mehr als 400 mal autoklavierbar

*Nailbrushes
 more than 400 times autoclavable*



RU 8880-05

Antibeschlagmittel, für Optiken, steril, 30 ml
Antifog solution for optics, sterile, 30 ml

Nadeldosen, Nierenschalen, Behälter
Needle cases, kidney bowls, receptacles



Nadeldosen
Needle cases



150 x 95 x 13 mm
RU 8914-00

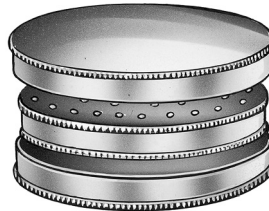

65 mm x 16 mm
RU 8916-01

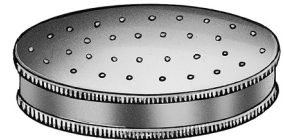

Innendose allein
Inner case only
RU 8916-11

Nierenschalen
Kidney bowls



0,25 l	170 x 36 mm	RU 8970-01
0,50 l	250 x 36 mm	RU 8970-02
0,75 l	275 x 45 mm	RU 8970-03

Medizinbecher
Medicine cups



25 cc	RU 8975-05
50 cc	RU 8975-10

Standgefäße
Jars



Ø x h	
55 x 120 mm	RU 8984-02
55 x 125 mm	RU 8984-03
50 x 180 mm	RU 8984-04
85 x 135 mm	RU 8984-05
85 x 175 mm	RU 8984-06
100 x 200 mm	RU 8984-07

Schalen
Bowls



Ø x h		
40 x 19 mm	0,05 l	RU 8985-10
61 x 30 mm	0,07 l	RU 8985-11
80 x 40 mm	0,14 l	RU 8985-01
116 x 50 mm	0,35 l	RU 8985-02
128 x 55 mm	0,45 l	RU 8985-03
147 x 65 mm	0,7 l	RU 8985-04
167 x 75 mm	1,1 l	RU 8985-05
187 x 85 mm	1,6 l	RU 8985-06



RUDOLF Medical GmbH + Co. KG, weltweit vertreten, vertraut auf bleibende Werte und setzt diese durch enge Kundenbeziehungen um. RUDOLF Medical bietet innovative Hightech-Produkte, Handinstrumente, starre Endoskope sowie effiziente Serviceleistungen für zahlreiche chirurgische Fachgebiete an.

RUDOLF Medical GmbH + Co. KG, represented worldwide, translates its belief in lasting values by fostering close customer relationships and offering innovative high technology products, hand instruments, rigid endoscopes as well as efficient services for numerous surgical disciplines.

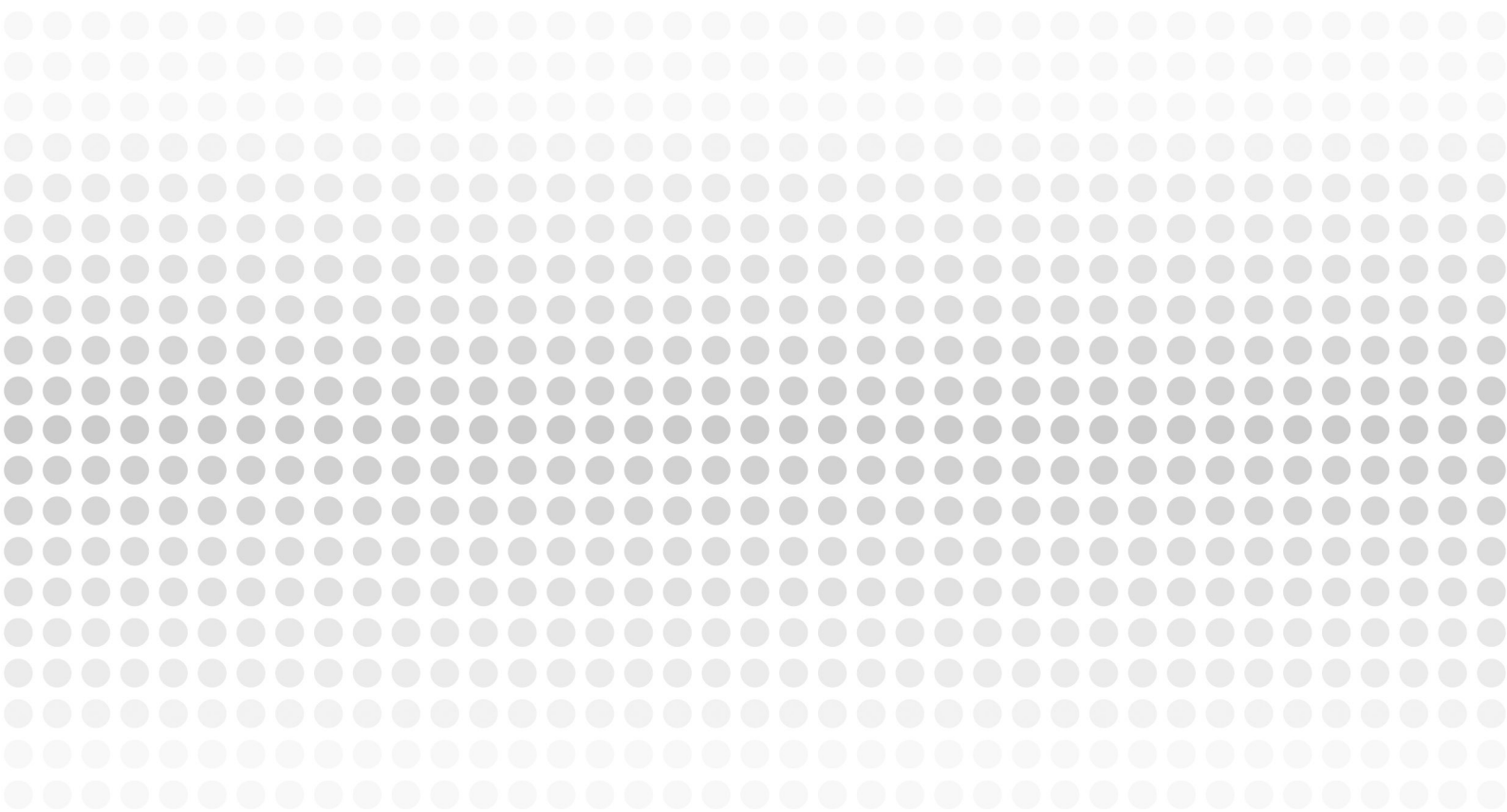

RUDOLF
BECAUSE WE CARE

RUDOLF Medical GmbH + Co. KG
Zollerstr. 1, 78567 Fridingen, Germany
Tel.: +49 7463 9956-0
sales@rudolf-med.com
www.rudolf-med.com



ZK 308 DE/EN Rev. 01.2024



Vertrieb durch:
Distributed by:

