

Cardiovascular and Thoracic Surgery



serving healthcare worldwide

RUDOLF MEDICAL GmbH + Co. KG
Postfach 28 · 78565 Fridingen, Germany
Zollerstraße 1 · 78567 Fridingen, Germany
Phone +49 (74 63) 99 56-0 · Fax +49 (74 63) 99 56-56
mail@rudolf-med.com · www.rudolf-med.com



**HERZ-THORAX- UND GEFÄSSCHIRURGIE
CARDIOVASCULAR AND THORACIC
SURGERY**

**CIRUGÍA CARDIOVASCULAR Y TORÁCICA
CHIRURGIE CARDIOVASCULAIRE ET
THORACIQUE**

**CHIRURGIA CARDIOVASCOLARE E
TORACICA**



Alle Produkte, deren Katalognummern mit TI enden sind aus Rein-Titan hergestellt. Die entsprechenden Katalognummern sind farblich gekennzeichnet. Titan-Instrumente bieten insbesondere im Bereich der Herzchirurgie große Vorteile. Da Titan 45% leichter als rostfreier Stahl ist, sind die daraus hergestellten Instrumente weit weniger traumatisierend. Titan ist absolut korrosionsbeständig. Die Anwendung von Titan bei der Herstellung von feinen und grazilen Instrumenten ermöglicht präzises und feinfühliges Arbeiten mit delikaten, flexiblen Produkten und bedeutet daher mehr Komfort für den Chirurgen. Ein weiterer Vorteil von Titan ist, daß das Material absolut antimagnetisch ist. Titan-Instrumente können von uns jederzeit repariert werden.

All items with a reference number ending with TI are made of pure titanium. These special catalogue numbers are colour-marked. Titanium instruments offer great advantages, especially in cardiovascular surgery. One of them is that titanium is 45% lighter than stainless steel, therefore the instruments are much more trauma-reducing. Furthermore, titanium guarantees a more precise and sensitive working and therefore more comfort for the surgeon. Titanium is absolutely antimagnetic and the instruments made of titanium can be repaired every time by RUDOLF.

Todos los productos cuyas referencias terminan en TI son fabricados de puro titanio. Las referencias correspondientes son marcadas de color. El instrumental de titanio ofrece grandes ventajas, sobre todo en el sector de la cirugía cardiovascular. Puesto que el titanio es un 45% más ligero que acero inoxidable, el instrumental fabricado de titanio disminuye el riesgo de lesiones. El titanio es absolutamente anticorrosivo. La utilización de titanio en la fabricación de instrumental fino y delicado posibilita un trabajo preciso y sensible con productos delicados y más flexibles y esto significa más confort para el cirujano. Otra ventaja de titanio es que el material es totalmente antimagnetizado. Los instrumentos de titanio siempre pueden ser reparados por nosotros.

Tous les produits avec un No d'article se terminant par TI sont fabriqués en pur titane. Les No d'articles sont marqués en couleur. Les instruments en titane offrent de grands avantages, particulièrement dans le domaine de la chirurgie cardio-vasculaire. Le titane est 45% plus léger que l'acier inox et, de ce fait, moins traumatisant. Le titane est totalement résistant à la corrosion et amagnétique. L'utilisation du titane pour des instruments fins et délicats procure au chirurgien un confort qui permet un travail précis et d'une grande sensibilité. Tous les instruments en titane sont réparables par Rudolf.

Tutti i prodotti con un numero d'articolo che termina con TI sono fabbricati in titanio puro. I numeri d'articolo sono marcati in colore. Gli strumenti in titanio offrono grandi vantaggi in particolare modo nel campo della chirurgia cardiovascolare. Il titanio è del 45% più leggero dell'acciaio inox, quindi meno traumatizzante. Il titanio è totalmente resistente alla corrosione ed amagnetico. L'uso del titanio per strumenti fini e delicati permette al chirurgo di lavorare con precisione e con una grande sensibilità. Tutti gli strumenti in titanio possono essere riparati presso la Rudolf.



0,6 mm



0,5 mm



0,4mm



0,2 mm – 0,3 mm



glatt
smooth
lisa
lisse
liscie



Rudolf
MIKRO-GRIP

Wir empfehlen Hartmetall-Maulteile
mit glatter Fläche und Mikro-Grip für Nahtmaterial 9/0-11/0
mit Teilung 0,2 mm – 0,3 mm und Mikro-Grip für Nahtmaterial 6/0-10/0
mit Teilung 0,4 mm für Nahtmaterial 4/0-6/0
mit Teilung 0,5 mm für Nahtmaterial bis 3/0
mit Teilung 0,6 mm für große Nadeln oder Draht

We recommend tungsten carbide jaws
with smooth surface and Micro Grip for suture material 9/0-11/0
with serration 0,2 mm – 0,3 mm and Micro Grip for suture material 6/0-10/0
with serration 0,4 mm for suture material 4/0-6/0
with serration 0,5 mm for suture material up to 3/0
with serration 0,6 mm for big needles or wire

Les recomendamos placas de tungsteno carburo con
superficie lisa y Micro-Grip para material de sutura 9/10-11/0
con dentado 0,2 mm – 0,3 mm y Micro-Grip para material de sutura 6/0-10/0
con dentado 0,4 mm para material de sutura 4/0-6/0
con dentado 0,5 mm para material de sutura hasta 3/0
con dentado 0,6 mm para agujas grandes o alambre

Nous recommandons des mors en carbure de tungstène
avec surface lisse et Micro-Grip pour des sutures 9/0-11/0
avec denture 0,2 mm – 0,3 mm et Micro-Grip pour des sutures 6/0-10/0
avec denture 0,4 mm pour des sutures 4/0-6/0
avec denture 0,5 mm pour des sutures jusqu'à 3/0
avec denture 0,6 mm pour des grandes aiguilles ou fils

Consigliamo il morso con placche di carburo di tungsteno
liscie e Micro-Grip per materiale da sutura 9/0-11/0
con zigrinatura 0,2 mm – 0,3 mm Micro Grip per materiale da sutura 6/0-10/0
con zigrinatura 0,4 mm per materiale da sutura 4/0-6/0
con zigrinatura 0,5 mm per materiale da sutura fino a 3/0
con zigrinature 0,6 mm per aghi grande oppure fili

MIKRO-GRIP PINZETTEN UND NADELHALTER

Unter dem Titel „Mikro-Grip“ bieten wir ein selektives Programm von Produkten mit Hartstoffbeschichtung an. Bei diesem Verfahren wird funkenerosiv Hartmetall (Wolframkarbid) auf und in die Werkstückoberfläche übertragen. Dabei liegen die eindeutigen Vorteile darin, daß sich diese Schicht durch Anschmelzen mit dem Grundwerkstoff verbindet. Ein Ausbrechen dieser Kristalle, wie dies häufig bei der Diamant-Beschichtung zu beobachten ist, ist damit ausgeschlossen, ein bedeutender Sicherheitsvorteil.

- Erhöhung der Oberflächenhärte (HV 1000 – 1400), und damit langlebige Griffigkeit des Instruments.
- Mikrofeine Beschichtung verhindert eine Beschädigung der Nadel bzw. des Nahtmaterials und damit eine klinisch riskante Traumatisierung.
- Die feine kristallisierte Maulfläche des Instruments verhindert das Verdrehen der Nadel oder des Nahtmaterials.
- Alle „Mikro-Grip“ Instrumente geben dem Chirurgen eine spürbar verbesserte Kontrolle über das Produkt, und damit über seine Arbeit.

MICRO-GRIP DISSECTING FORCEPS AND NEEDLE HOLDERS

With „Micro-Grip Instruments“ we are offering a selective range of products with tungsten carbide coating.

In the manufacturing procedure of these instruments, tungsten carbide is put on to the instrument's jaw by emitting sparks. The definitive advantage of this procedure is that the tungsten carbide coat combines with the basic material by melting together. The breaking out of the crystals, as it can occur with diamant coatings, therefore is hardly possible.

The Micro-Grip instruments have important advantages:

- a higher grade of surface hardness (HV 1000 – 1400) and therefore a long-lasting „grip“ of the instruments.
- the micro-fine coating avoids the damage of the needle resp. the suture material and therefore a clinically dangerous traumatization.
- the fine crystallized jaw of the instruments avoids the twisting of the needle or the suture material.
- all Micro-Grip instruments allow the surgeon a perceptibly increased control over the product and, in consequence, over his work.

MICRO-GRIP PINZAS DE DISECCION Y PORTA-AGUJAS

Bajo la denominación „Micro-Grip“ ofrecemos un programa selectivo de productos con recubrimiento de carburo tungsteno.

En este procedimiento el carburo tungsteno se transmite por proyección de chispas a la superficie de la materia prima. La clara ventaja de este procedimiento es que el recubrimiento se une por fundación con la materia prima. Contrariamente al recubrimiento con diamantes, estos cristales no se rompen lo que significa una ventaja de seguridad considerable.

Estos instrumentos ofrecen las siguientes ventajas:

- Aumento del temple de la superficie (HV 1000 – 1400) y por lo tanto adherencia de larga duración del instrumento.
- Un recubrimiento micro-fino evita un deterioro de la aguja y del material de sutura y, por consecuencia, evita lesiones arriesgadas.
- La superficie cristalina de la boca evita la torsión de la aguja y del material de sutura.
- El instrumental „Micro-Grip“ garantiza al cirujano un control sobre el producto sensiblemente mejorado y por lo tanto un control sobre su trabajo.

PINCES ET PORTE-AIGUILLES MICRO-GRIP

Sous le titre „Micro-Grip“, nous proposons un programme sélectif d'articles avec un revêtement de carbure de tungstène.

Lors du procédé de fabrication de ces instruments, le carbure de tungstène est appliqué sur la surface du mors de l'instrument par émission d'étincelles. L'énorme avantage de ce procédé est que cela permet au revêtement de carbure de tungstène de se lier parfaitement au support. Les cristaux ainsi formé, contrairement au revêtement diamant, peuvent très difficilement se rompre.

Les instruments Micro-Grip ont les avantages suivants:

- une haute valeur de dureté superficielle (HV 1000 – 1400) assurant ainsi une excellente longévité du mors de l'instrument.
- le revêtement extrêmement fin évite tout endommagement de l'aiguille et du matériel de suture, réduisant par conséquent le risque de lésions.
- la surface cristalline de l'instrument évite la torsion de l'aiguille et du matériel de suture.
- l'instrumentation Micro-Grip garantit au chirurgien un contrôle de l'instrument sensiblement amélioré, donc un meilleur travail.

PINZE E PORTAGHI MICRO-GRIP

Presentiamo sotto il titolo „Micro-Grip“ un programma selettivo di strumenti con un rivestimento di carburo di tungsteno.

Durante il processo di fabbricazione di questi strumenti, il carburo di tungsteno viene depositato sulla superficie dello morso mediante un'emissione di scintille. Il grande vantaggio di questo processo risiede nel fatto che il rivestimento di carburo di tungsteno si può legare perfettamente con il supporto. I cristalli così formati, al contrario del rivestimento diamante, possono difficilmente rompersi.

Gli strumenti Micro-Grip hanno i seguenti vantaggi:

- Un'alta durezza superficiale (HV 1000 – 1400) che assicura una maggiore longevità del morso dello strumento.
- Il rivestimento molto fine impedisce il danneggiamento dell'ago e del materiale da sutura, quindi riduce i rischi di lesioni.
- La superficie cristallina del morso impedisce la rotazione dell'ago e del materiale da sutura.
- Lo strumentario Micro-Grip garantisce al chirurgo un perfetto controllo dello strumento migliorando così il suo lavoro.

Übersichtstafel
General Content
Cuadro sinóptico
Table des matières
Indice delle sezioni



Scheren
Scissors
Tijeras
Ciseaux
Forbici

2 – 22



Klemmen, Gefäßclips
Forceps, Vascular Clips
Pinzas hemostáticas, Clips vasculares
Pincas hémostatiques, Clips vasculaires
Pinze emostatiche, Serrafini

24 – 39



Pinzetten
Dissecting Forceps
Pinzas de disección
Pincas à disséquer
Pinze anatomiche

42 – 46



Wundhaken, Wundsperrer
Retractors, Self Retaining Retractors
Separadores y ganchos
Ecarteurs et Crochets
Divaricatori ed uncini

48 – 56



Gefäßinstrumente
Vessel Instruments
Instrumental vascular
Instruments pour vaisseaux
Strumenti vascolari

58 – 66



Knocheninstrumente
Bone Instruments
Instrumental óseo
Instruments à os
Strumenti ossea

68 – 74



Drahtinstrumente
Wire Instruments
Instrumental para alambre
Instruments à fils
Strumenti per fili

76 – 78



Nadelhalter
Needle Holders
Porta-agujas
Porte-aiguilles
Portaghi

80 – 90



Gewebe- und Organfaßzangen
Tissue and Organ Grasping Forceps
Pinzas para coger tejidos y órganos
Pinces à tissue et à saisir les organes
Pinze per afferrare tessuti ed organi

92, 93



Rippenscheren, Sternumscheren
Rib Shears, Sternum Scissors
Costótomos, Tijeras de esternón
Costotomes, Ciseaux à sternum
Costotomi, Forbici per sterno

96 – 98



Rippensperrer
Rib Spreaders
Separadores costales
Ecarteurs costaux
Divaricatori costali

100 – 108



Gefäßklemmen, Atrauma Klemmen
Vessel Clamps, Atraumatic Clamps
Clamps vasculares, Clamps atraumaticos
Clamps vasculaires, Clamps atraumatiques
Pinze vascolari atraumatiche

110 – 158



Etus für Bulldogklemmen
Cases for Bulldog Clamps
Estuches para clamps Bulldog
Boîtes pour clamps bulldog
Scatole per pinze Bulldog

160



Der Ihnen vorliegende Cardiovascular-Katalog ist auf ihren Namen registriert. Er darf nur zum Verkauf von RUDOLF-Instrumenten verwendet werden.

Nachdruck, auch auszugsweise, ist verboten.

Alle unsere Kataloge und Prospekte sowie Preislisten dürfen Dritten nicht zugänglich gemacht werden. Es gelten unsere allgemeinen Lieferungs- und Zahlungsbedingungen, die in unserer Preisliste enthalten sind.

Modelländerungen behalten wir uns vor.

Ausgabe 2010

The catalogue you have in hands is registered in your name. It may only be used for the sale and promotion of RUDOLF products.

No part of this publication may be reproduced. None of our catalogues may be opened to third parties. All deliveries are subject to the general conditions of payment and supply which may be found in our price list.

Patterns are subject to change.

Edition 2010

El presente catálogo cardiovascular está registrado a su nombre. Solo se puede utilizar para la venta de instrumental RUDOLF.

Se prohíbe la reproducción total o parcial del presente catálogo. Todos nuestros catálogos y listas de precios son entregados a nivel personal por lo que no deben ser puestos al alcance de terceros. Las condiciones generales de pago y entrega, rigen las que se encuentran expresadas en nuestra lista de precios.

Nos reservamos del derecho de cambiar o modificar los modelos de nuestro catálogo.

Edición de 2010

Le présent catalogue est enregistré à votre nom. Il doit être utilisé exclusivement pour la vente d'instruments RUDOLF.

Toutes copies ou extraits sont interdits. Tous nos catalogues ou prospectus ne peuvent être donnés à une tierce. Nos conditions de livraison et de paiement sont celles stipulés sur notre liste de prix.

Nous nous réservons tout droit de modification sur les modèles présentés dans le catalogue.

Édition 2010

Il presente catalogo è registrato a Suo nome. Deve essere utilizzato solo per la vendita degli strumenti RUDOLF.

Riproduzioni, anche solo per dimostrazione, sono vietate. I nostri cataloghi e depliant, come anche i listini prezzi, non possono essere resi accessibili a tutti. Valgono le nostre condizioni di fornitura e pagamento che sono contenute nel nostro listino prezzi.

Ci riserviamo il diritto di modificare i prodotti di questo catalogo.

Edizione 2010

Scheren
Scissors
Tijeras
Ciseaux
Forbici

 **rudolf**[®]
MEDICAL

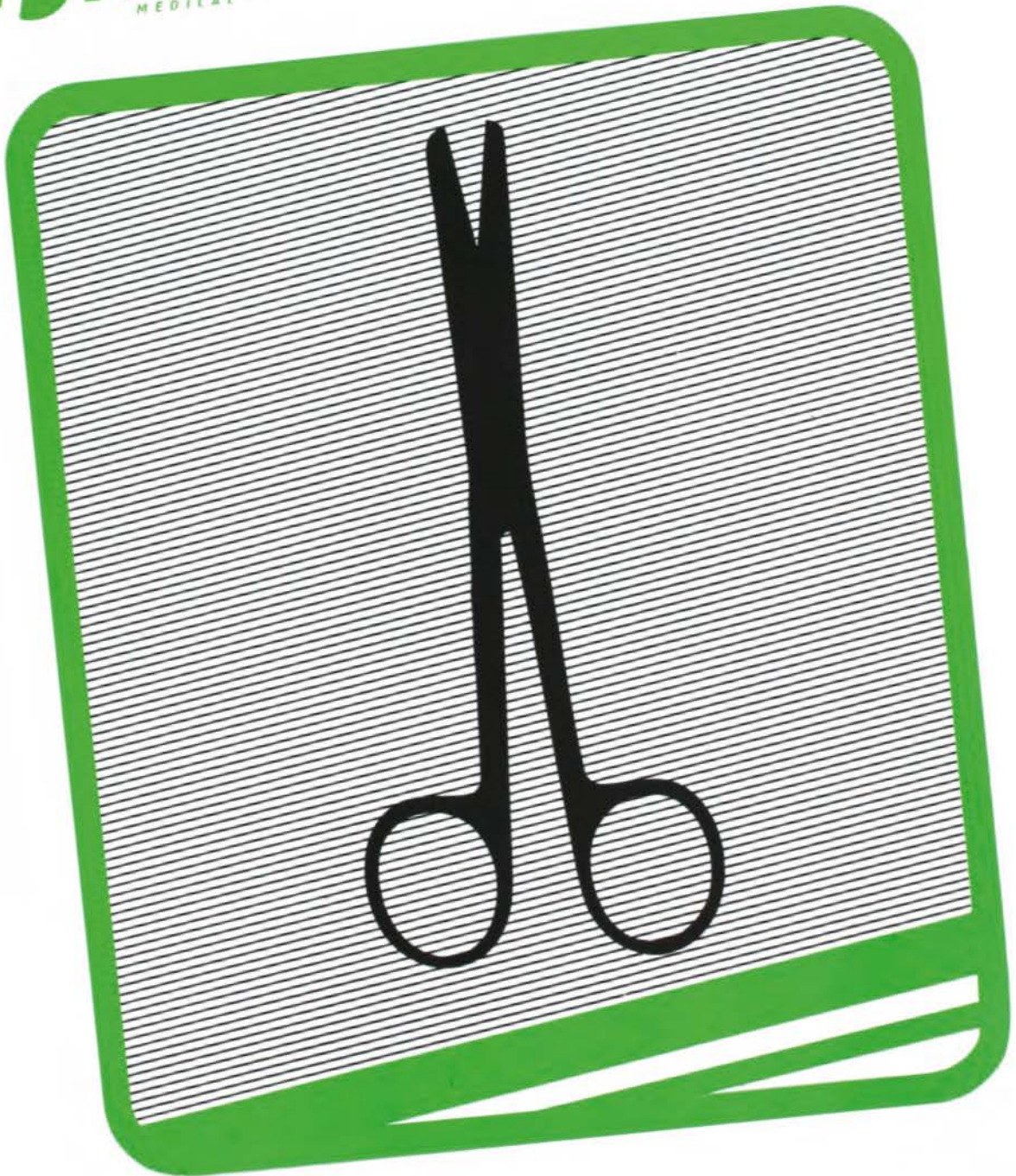



Chirurgische Scheren
 Operating Scissors
 Tijeras para cirugía
 Ciseaux chirurgicaux
 Forbici per chirurgia



gerade
 straight
 rectas
 droits
 rette

Standard
 Fig. 1



gerade
 straight
 rectas
 droits
 rette

Standard
 Fig. 2



gerade
 straight
 rectas
 droits
 rette

Standard
 Fig. 3

14,5 cm/5³/₄"

RU 1001-14

RU 1002-14

RU 1003-14

15,5 cm/6"

RU 1001-15

RU 1002-15

RU 1003-15

16,5 cm/6¹/₂"

RU 1001-16

RU 1002-16

RU 1003-16

Rudolf
 TC



gerade
 straight
 rectas
 droits
 rette

Standard

14,5 cm/5³/₄"

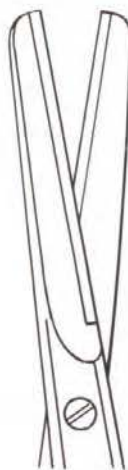

Fig. 1
 RU 1004-14

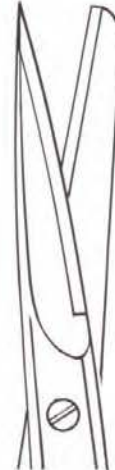

Fig. 2
 RU 1006-14



Fig. 3
 RU 1008-14



gebogen
 curved
 curvas
 courbes
 curve

Standard
 Fig. 1



gebogen
 curved
 curvas
 courbes
 curve

Standard
 Fig. 2



gebogen
 curved
 curvas
 courbes
 curve

Standard
 Fig. 3

14,5 cm/5 ³ / ₄ "	RU 1011-14	RU 1012-14	RU 1013-14
15,5 cm/6"	RU 1011-15	RU 1012-15	RU 1013-15
16,5 cm/6 ¹ / ₂ "	RU 1011-16	RU 1012-16	RU 1013-16

Rudolf
 TC



gebogen
 curved
 curvas
 courbes
 curve

Standard
 14,5 cm/5³/₄"

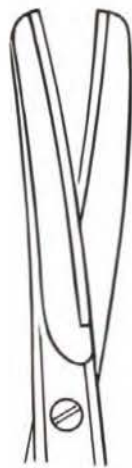

Fig. 1
 RU 1014-14



Fig. 2
 RU 1016-14

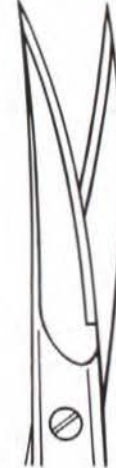

Fig. 3
 RU 1018-14



Ligaturscheren
Ligature Scissors
Tijeras para ligaduras
Ciseaux à ligatures
Forbici per legature



Ligaturscheren speziell zum Schneiden von Nahtmaterial

- Hartmetalleinlagen gewährleisten dauerhafte Schnittschärfe
- eine speziell angebrachte feinste Zahnung verhindert das Abgleiten des Nahtmaterials

Ligature scissors especially for the cutting of suture material

- TC inserts ensure permanent sharpness
- an especially made most finest serration prevents the slipping of the suture material

Tijeras para ligaduras especialmente para cortar material de sutura

- placas de TC garantizan un corte permanente
- un dentado muy fino evita un deslizamiento del material de sutura

Ciseaux à ligatures pour couper le matériel à suture

- les plaques en TC garantissent une coupure permanente
- la denture plus fine évite la glissade du matériel à suture

Forbici per legature speciali per tagliare materiale da sutura

- con inserti TC affinché l'affilatura si mantenga nel tempo
- con una dentellatura fine per impedire un eventuale scivolamento del materiale da sutura



Mayo

Metzenbaum

14,5 cm/5¾"	RU 1253-14 RS	RU 1314-14 RS
17 cm/6¾"	RU 1253-17 RS	
18 cm/7"		RU 1334-18 RS
23 cm/9"	RU 1253-23 RS	RU 1334-23 RS
26 cm/10¼"		RU 1334-26 RS



Rudolf
TC

gebogen
curved
curvas
courbes
curve

RU 1103-16

Lexer
16 cm/6¹/₄"



Rudolf
SUPERCUT TC

gezahnt
saw edge
dentadas
dentelés
dentellate

RU 1103-16 MC



gerade
straight
rectas
droits
rette

Mayo



gebogen
curved
curvas
courbes
curve

Mayo



Rudolf
TC

gerade
straight
rectas
droits
rette

Mayo



gebogen
curved
curvas
courbes
curve

14,5 cm/5 ³ / ₄ "	RU 1250-14	RU 1251-14	RU 1252-14	RU 1253-14
17 cm/6 ³ / ₄ "	RU 1250-17	RU 1251-17	RU 1252-17	RU 1253-17
23 cm/9"	RU 1250-23	RU 1251-23	RU 1252-23	RU 1253-23
28 cm/11"	RU 1250-28	RU 1251-28		



Präparierscheren
Dissecting Scissors
Tijeras para preparaciones
Ciseaux à dissection
Forbici per dissezione



gebogen
curved
curvas
courbes
curve

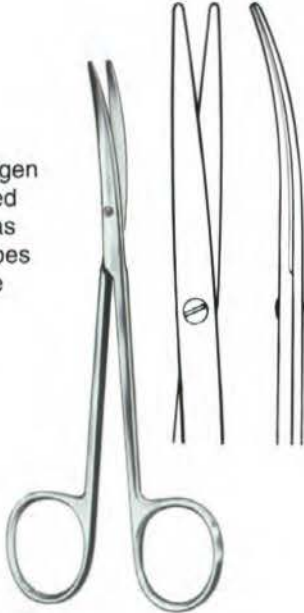

Metzenbaum-Fino

14,5 cm/5³/₄"
RU 1291-14

Rudolf[®]
TC

gerade
straight
rectas
droits
rette

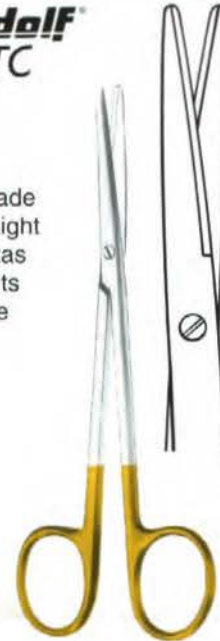

Metzenbaum

14,5 cm/5³/₄"
RU 1304-14

Rudolf[®]
TC

gebogen
curved
curvas
courbes
curve



Metzenbaum

14,5 cm/5³/₄"
RU 1314-14



Metzenbaum-Fino

14,5 cm/5³/₄"
RU 1316-14

Präparierscheren
Dissecting Scissors
Tijeras para preparaciones
Ciseaux à dissection
Forbici per dissezione



gerade
 straight
 rectas
 droits
 rette

	Metzenbaum	Metzenbaum-Fino
18 cm/7"	RU 1324-18	RU 1326-18
20 cm/8"	RU 1324-20	RU 1326-20
23 cm/9"	RU 1324-23	RU 1326-23
25 cm/10"	RU 1324-25	RU 1326-25
28 cm/11"	RU 1324-28	RU 1326-28
30 cm/12"	RU 1324-30	



gebogen
 curved
 curvas
 courbes
 curve

Rudolf
TC

gebogen
 curved
 curvas
 courbes
 curve

	Metzenbaum-Fino	Metzenbaum	Metzenbaum	Metzenbaum-Fino
18 cm/7"	RU 1330-18	RU 1331-18	RU 1334-18	RU 1336-18
20 cm/8"	RU 1330-20	RU 1331-20	RU 1334-20	RU 1336-20
23 cm/9"	RU 1330-23	RU 1331-23	RU 1334-23	RU 1336-23
25 cm/10"	RU 1330-25	RU 1331-25	RU 1334-25	RU 1336-25
28 cm/11"	RU 1330-28	RU 1331-28	RU 1334-28	RU 1336-28
30 cm/12"		RU 1331-30	RU 1334-30	



**Präparierscheren, Chirurgische Scheren
 Dissecting Scissors, Operating Scissors
 Tijeras para preparaciones, Tijeras para cirugía
 Ciseaux à dissection, Ciseaux chirurgicaux
 Forbici per dissezione, Forbici per chirurgia**



gezahnt
saw edge
dentadas
dentelés
dentellate

gebogen
curved
curvas
courbes
curve

Metzenbaum

Metzenbaum

14,5 cm/5¾"	RU 1314-14 MC	RU 1339-15
18 cm/7"	RU 1334-18 MC	RU 1339-18
20 cm/8"	RU 1334-20 MC	RU 1339-20
23 cm/9"	RU 1334-23 MC	RU 1339-23
26 cm/10¼"		RU 1339-26
	Metzenbaum-Fino	
18 cm/7"	RU 1336-18 MC	



Kelly

RU 1440-18



Kelly

RU 1441-18

18 cm/7"



Rudolf
 SUPERCUT

gezahnt
 saw edge
 dentadas
 dentelés
 dentellate

gerade – straight
 rectas – droits
 rette

gebogen – curved
 curvas – courbes
 curve

Reynolds

RU 1580-15 MC 15 cm/6" **RU 1582-15 MC**



gerade – straight
 rectas – droits
 rette



gebogen – curved
 curvas – courbes
 curve

Reynolds

RU 1580-15 15 cm/6" **RU 1581-15**
RU 1580-18 18 cm/7" **RU 1581-18**



gebogen – curved
 curvas – courbes
 curve

Jameson-Werber

13 cm/5"
RU 1584-13



gerade – straight
 rectas – droits
 rette



gebogen – curved
 curvas – courbes
 curve

Joseph

RU 1670-14 14 cm/5½" **RU 1671-14**



Gefäßscheren
Vascular Scissors
Tijeras vasculares
Ciseaux vasculaires
Forbici vascolari



Koronar-Schere
Coronary scissors
Tijeras coronarias
Ciseaux coronaires
Forbici coronari



11,5 cm/4½"
RU 1705-11



Potts-Smith
19,5 cm/7¾"
RU 1710-19



De Bakey
15,5 cm/6"
RU 1713-15



De Bakey
15,5 cm/6"
RU 1714-15



Favaloro
15 cm/6"
RU 1715-15



Rudolf
 SUPERCUT

Endarterektomie-Schere
 Endarterectomy scissors
 Tijeras para endarterectomia
 Ciseaux pour endartérectomie
 Forbici per endarterectomia



gezahnt
 saw edge
 dentadas
 dentelés
 dentellate

17 cm/6³/₄"
 RU 1718-17 MC

Rudolf
 SUPERCUT

gezahnt
 saw edge
 dentadas
 dentelés
 dentellate

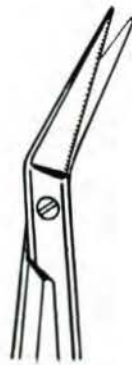

25°
 RU 1720-19 MC

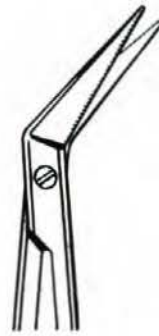

45°
 RU 1721-19 MC

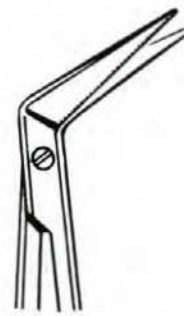

60°
 RU 1722-19 MC

Potts-Smith
 19 cm/7¹/₂"



Gefäßscheren
Vascular Scissors
Tijeras vasculares
Ciseaux vasculaires
Forbici vascolari



Rudolf
TC

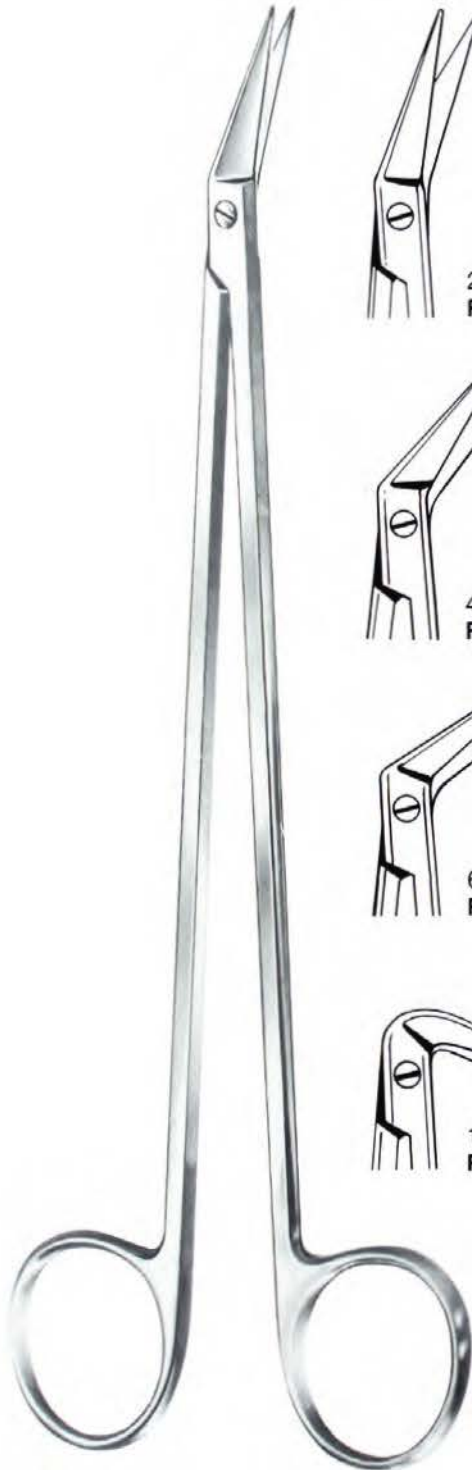

Potts-Smith
19 cm/7 1/2"

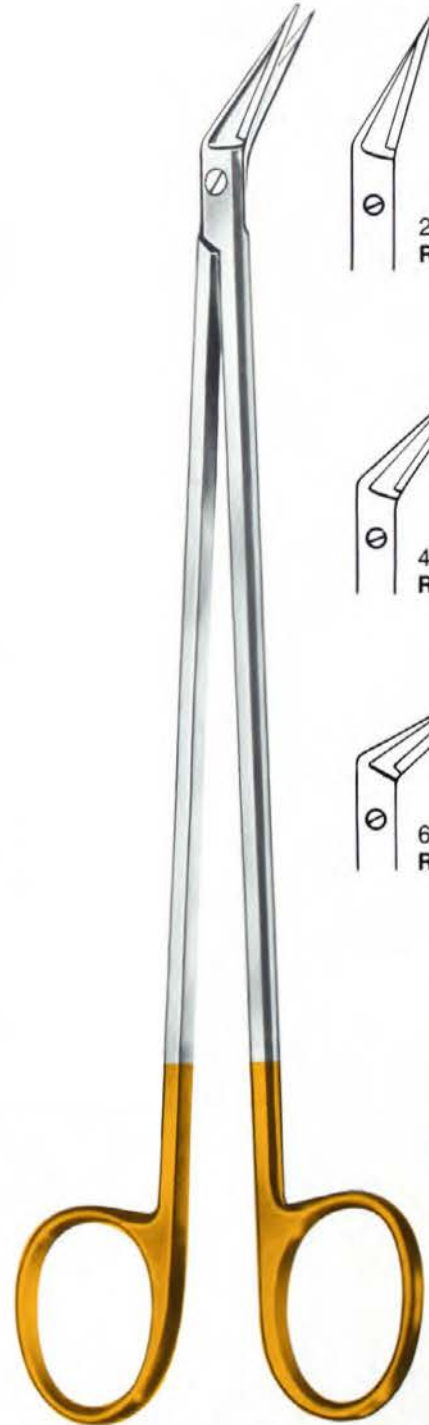
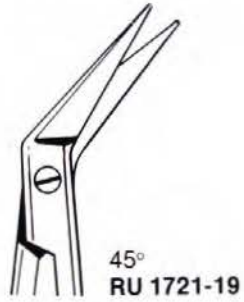
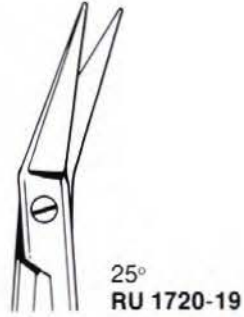

Potts-Smith
19 cm/7 1/2"

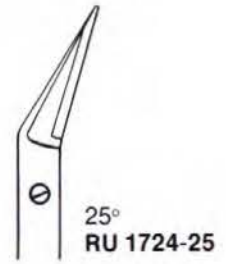



Potts-Smith
 19 cm/7½"
 RU 1735-19



Jorgensen
 22 cm/8¾"
 RU 1739-22



Satinsky
 24,5 cm/10"
 RU 1740-24



Rudolf
TC
 RU 1744-23

Klingenberg-Loth
 23 cm/9"
 RU 1745-23

Rudolf
TC



Tönnis-Adson
 17,5 cm/7"
 RU 1829-17



Gefäßscheren
 Vascular Scissors
 Tijeras vasculares
 Ciseaux vasculaires
 Forbici vascolari



DeBakey



25°

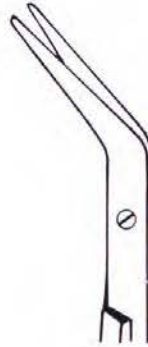

45°

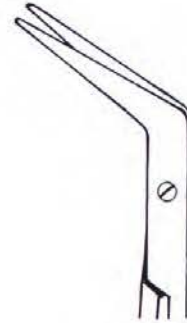

60°

cm	in			
16 cm	6 1/4"	RU 1750-16	RU 1752-16	RU 1754-16
23 cm	9"	RU 1750-23	RU 1752-23	RU 1754-23
28 cm	11"	RU 1750-28		RU 1754-28



18 cm/7"	RU 1755-25	RU 1755-45	RU 1755-60
23 cm/9"	RU 1756-25	RU 1756-45	RU 1756-60



Baby-Hegemann

13,5 cm/5 1/4"

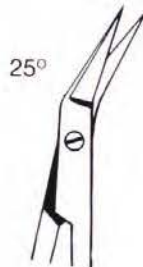

25°



45°



60°



90°



125°

cm	in					
13,5 cm	5 1/4"	RU 1760-13	RU 1761-13	RU 1762-13	RU 1763-13	
16 cm	6 1/4"	RU 1760-16	RU 1761-16	RU 1762-16	RU 1763-16	RU 1764-16
19 cm	7 1/2"	RU 1760-19	RU 1761-19	RU 1762-19	RU 1763-19	RU 1764-19

Hegemann (Diethrich)

16 cm/6 1/4"
 19 cm/7 1/2"



Hegemann (Diethrich)

19 cm/7 1/2"
 RU 1765-19



Gefäßscheren
 Vascular Scissors
 Tijeras vasculares
 Ciseaux vasculaires
 Forbici vascolari



18 cm/7"

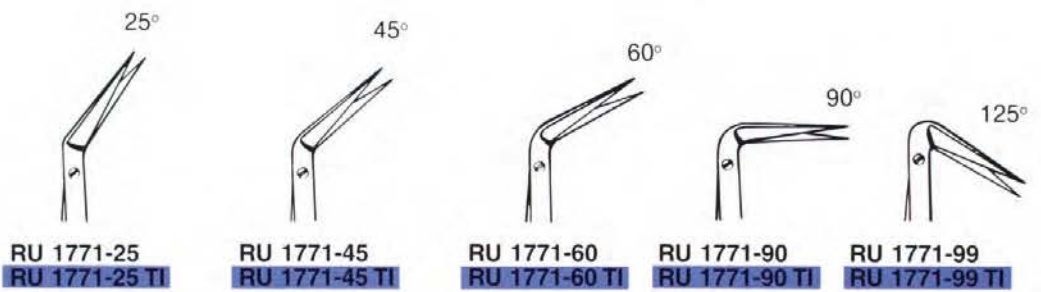
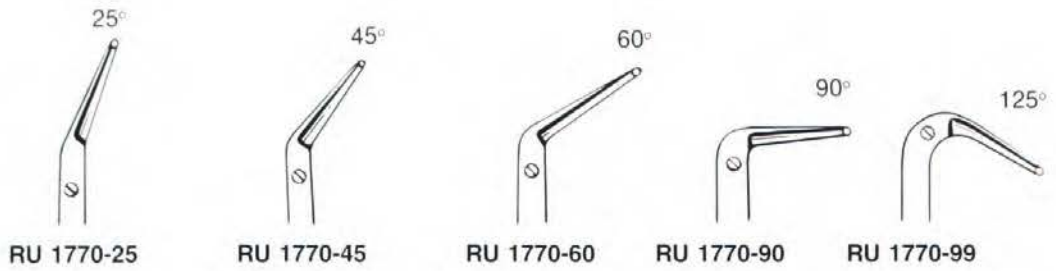

18 cm/7"

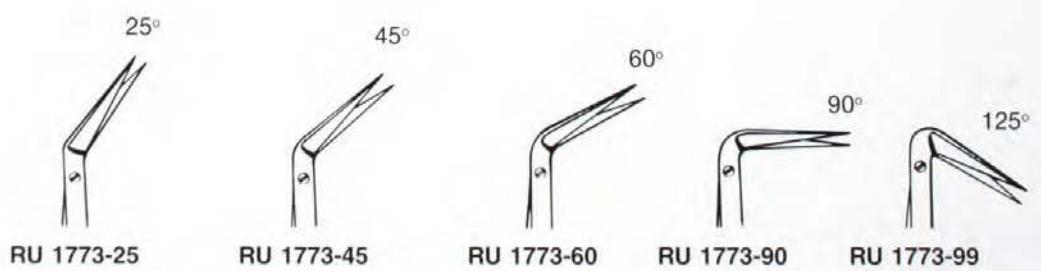
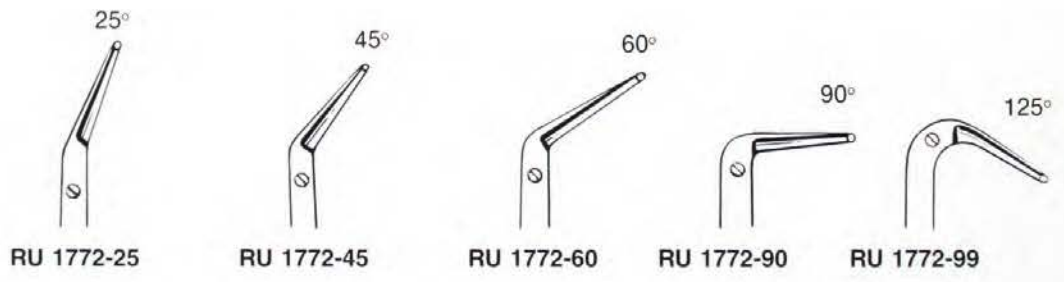

TI = TITAN



Gefäßscheren
 Vascular Scissors
 Tijeras vasculares
 Ciseaux vasculaires
 Forbici vascolari



Jacobsen
 18 cm/7"

RU 2350-18
RU 2350-18 TI



RU 2360-19

RU 2351-18
RU 2351-18 TI



RU 2361-19

RU 2352-18



RU 2362-19

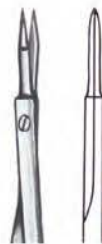

RU 2364-19



RU 2365-19



19 cm/7 1/2"

TI = TITAN



gerade
 straight
 rectas
 droits
 rette

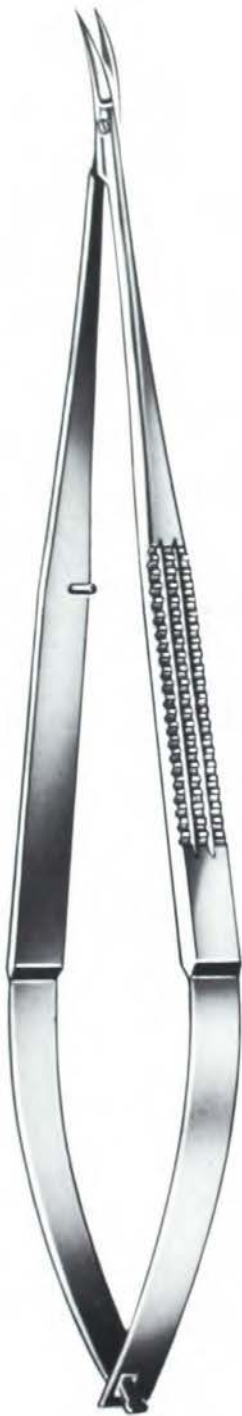

gebogen
 curved
 curvas
 courbes
 curve

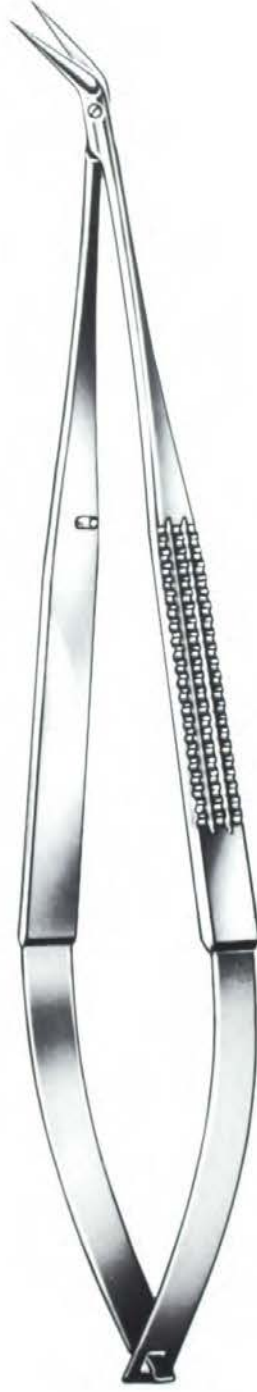

kniegebogen
 angulated
 acodadas
 coudés
 angolate



gerade
 straight
 rectas
 droits
 rette



gebogen
 curved
 curvas
 courbes
 curve

16 cm/6¼" RU 2370-16
 18,5 cm/7¼" RU 2370-18

RU 2371-16
 RU 2371-18

RU 2375-18

RU 2372-16

RU 2373-16



Mikroscheren
 Micro Scissors
 Micro-tijeras
 Micro-ciseaux
 Micro-forbici

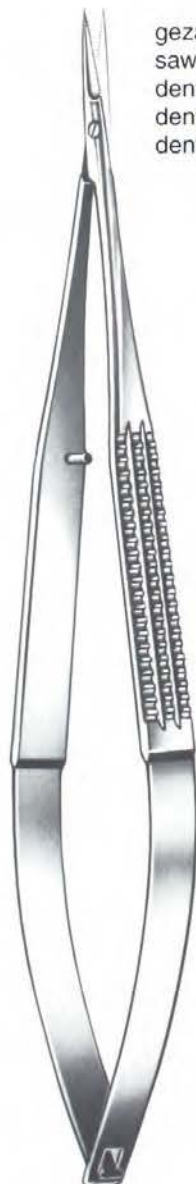

gezahnt
 saw edge
 dentadas
 dentelés
 dentellate

Millesi
 gerade
 straight
 rectas
 droits
 rette

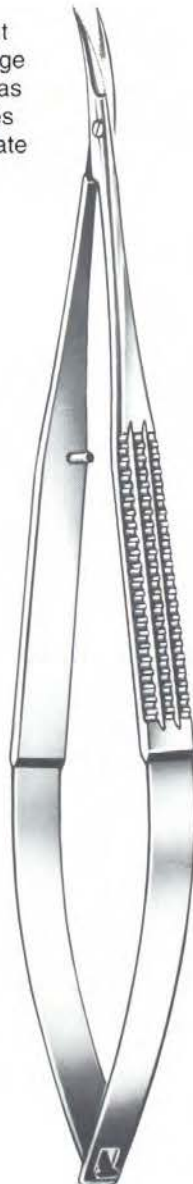

Millesi
 gebogen
 curved
 curvas
 courbes
 curve



Venenschiere
 Vein scissors
 Tijeras para venotomia
 Ciseaux à veines
 Forbici per le vene

gerade
 straight
 rectas
 droits
 rette

13 cm/5"

16 cm/6¼"

RU 2376-16

RU 2377-16

RU 2370-01/13



gerade
 straight
 rectas
 droits
 rette



gebogen
 curved
 curvas
 courbes
 curve



kniegebogen
 angulated
 acodadas
 coudés
 angolate



gerade
 straight
 rectas
 droits
 rette



gebogen
 curved
 curvas
 courbes
 curve

14,5 cm/5¾"

RU 2380-14

RU 2388-14

16 cm/6¼"

RU 2380-16

RU 2381-16

RU 2382-16

RU 2383-16

RU 2382-18

RU 2383-18

RU 2385-18

18,5 cm/7¼"

RU 2382-18 TI

RU 2383-18 TI

RU 2382-23

23 cm/9"

RU 2382-23 TI



Mikroscheren
 Micro Scissors
 Micro-tijeras
 Micro-ciseaux
 Micro-forbici



Präparierschere
 Dissecting scissors
 Tijeras para preparaciones
 Ciseaux à dissection
 Forbici per preparazione

gezahnt
 saw edge
 dentadas
 dentelés
 dentellate



gerade
 straight
 rectas
 droits
 rette



gebogen
 curved
 curvas
 courbes
 curve



gebogen
 curved
 curvas
 courbes
 curve

14,5 cm/5¾"

RU 2386-16

RU 2386-16 TI

RU 2387-16

RU 2387-16 TI

16 cm/6¼"

18 cm/7"

RU 2389-14

TI = TITAN

Gefäßscheren
Vascular Scissors
Tijeras vasculares
Ciseaux vasculaires
Forbici vascolari



Potts-de Martel
21 cm/8¹/₄"
RU 2490-21



Mills
21 cm/8¹/₄"
RU 2491-21



RU 2496-22



Strully
22 cm/8³/₄"

RU 2497-22



Klemmen, Gefäßclips
Forceps, Vascular Clips
Pinzas hemostáticas, Clips vasculares
Pincers hémostatiques, Clips vasculaires
Pinze emostatiche, Serrafini

 **rudolf**
MEDICAL

Atrauma-Klemmen siehe Seite 115 – 156
Atraumatic clamps see page 115 – 156
Clamps atraumaticos ver página 115 – 156
Clamps atraumatiques voir page 115 – 156
Pinze atraumatiche, vedere pagina 115 – 156

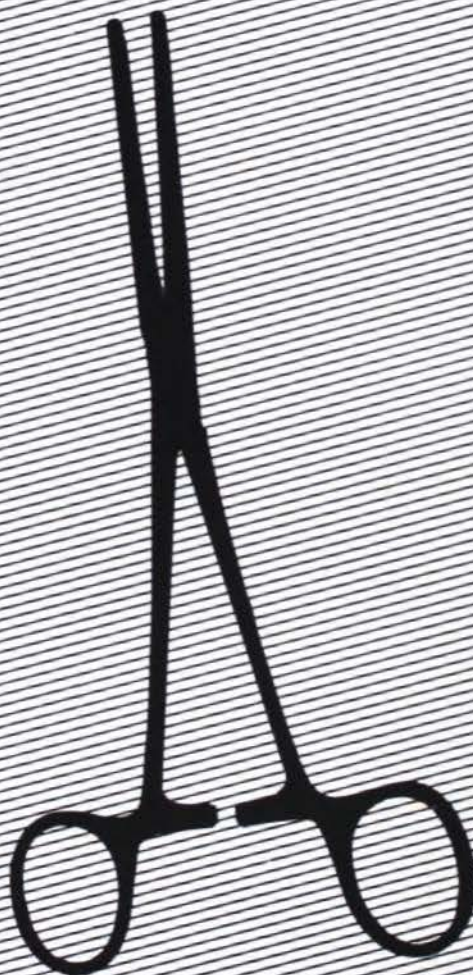



Arterienklemmen
Hemostatic Forceps
Pinzas hemostáticas
Pinces hémostatiques
Pinze emostatiche



gerade
straight
rectas
droites
rette



Rochester-Péan

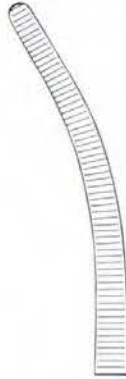

gebogen
curved
curvas
courbes
curve



gerade
straight
rectas
droites
rette

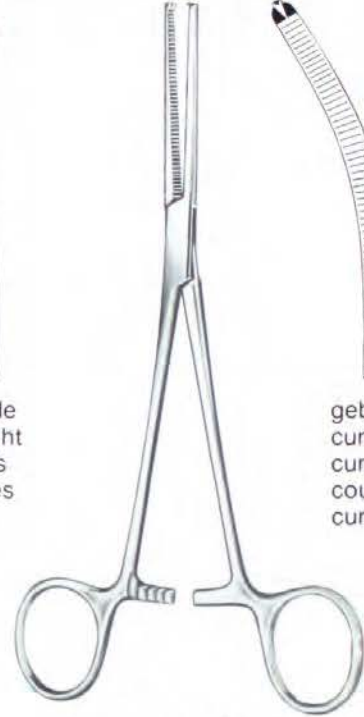

Ochsner-Kocher

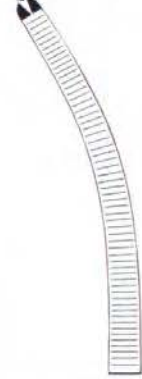

gebogen
curved
curvas
courbes
curve

		cm	in		
RU 3000-16	RU 3001-16	16	6 ¹ / ₄	RU 3010-16	RU 3011-16
RU 3000-18	RU 3001-18	18	7	RU 3010-18	RU 3011-18
RU 3000-20	RU 3001-20	20	8	RU 3010-20	RU 3011-20
RU 3000-22	RU 3001-22	22	8 ³ / ₄	RU 3010-22	RU 3011-22
RU 3000-24	RU 3001-24	24	9 ¹ / ₂	RU 3010-24	RU 3011-24
RU 3000-26	RU 3001-26	26	10 ¹ / ₄	RU 3010-26	RU 3011-26
RU 3000-30	RU 3001-30	30	12	RU 3010-30	RU 3011-30



gerade
straight
rectas
droites
rette



Péan

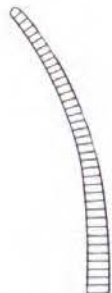

gebogen
curved
curvas
courbes
curve

fein
fine
finas
fines
fini



gerade
straight
rectas
droites
rette



Kocher



gebogen
curved
curvas
courbes
curve

		cm	in		
RU 3020-13	RU 3021-13	13	5	RU 3030-13	RU 3031-13
RU 3020-14	RU 3021-14	14	5 ¹ / ₂	RU 3030-14	RU 3031-14



Leriche
 15 cm/6"



RU 3080-15
 RU 3080-15 TI



RU 3081-15
 RU 3081-15 TI



RU 3082-15
 RU 3082-15 TI



RU 3083-15
 RU 3083-15 TI



Halsted-Mosquito
 12,5 cm, 5"



RU 3100-12
 RU 3100-12 TI



RU 3101-12
 RU 3101-12 TI



RU 3110-12
 RU 3110-12 TI



RU 3111-12
 RU 3111-12 TI



Halsted-Mosquito
 18 cm/7"
 21 cm/8 1/4"



RU 3100-18
 RU 3100-21



RU 3101-18
 RU 3101-21



RU 3110-18
 RU 3110-21

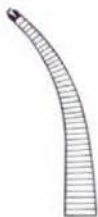

RU 3111-18
 RU 3111-21

sehr fein
 very fine
 muy finas
 très fines
 molto fini



Jacobson-Halsted
 13 cm/5"



RU 3114-13



RU 3115-13



Arterienklemmen, Präparier- und Ligaturklemmen
Hemostatic Forceps, Dissecting and Ligature Forceps
Pinzas hemostáticas, Pinzas para preparaciones y ligaduras
Pinces hémostatiques, Pinces à disséquer et à ligatures
Pinze emostatiche, Pinze per dissezione e legature



Micro-Mosquito

10 cm/4"
12 cm/4¾"

RU 3120-10
RU 3120-12

RU 3121-10
RU 3121-12
RU 3121-12TI

10 cm/4"
12 cm/4¾"

RU 3122-10
RU 3122-12

RU 3123-10
RU 3123-12
RU 3123-12TI



Hartmann
10 cm/4"

RU 3140-10
RU 3140-10TI

RU 3141-10
RU 3141-10TI



Adson
18,5 cm/7¼"

RU 3200-18

RU 3201-18



Baby-Adson

14 cm/5½"
RU 3205-14

18 cm/7"
RU 3205-18

Arterienklemmen, Präparier- und Ligaturklemmen
 Hemostatic Forceps, Dissecting and Ligature Forceps
 Pinzas hemostáticas, Pinzas para preparaciones y ligaduras
 Pincès hémostatiques, Pincès à disséquer et à ligatures
 Pinze emostatiche, Pinze per dissezione e legature



sehr fein
 very fine
 muy finas
 très fines
 molto fini



Jacobson-Adson
 18 cm/7"

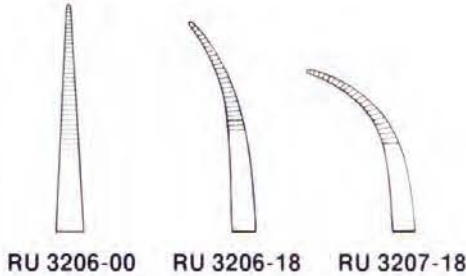

Diethrich

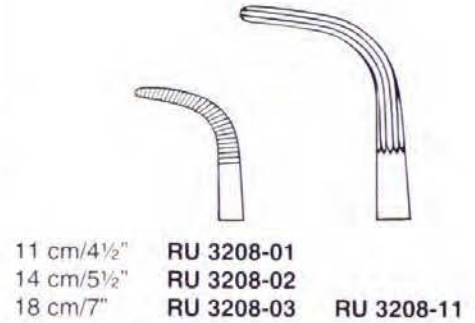

11 cm/4½"
 14 cm/5½"
 18 cm/7"

RU 3208-01
 RU 3208-02
 RU 3208-03

RU 3208-11



Bengolea

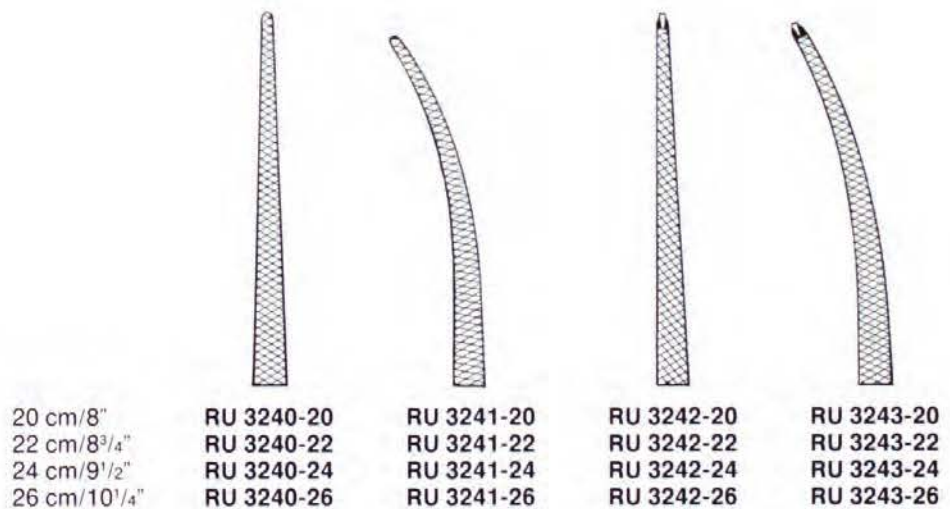

20 cm/8"
 22 cm/8¾"
 24 cm/9½"
 26 cm/10¼"

RU 3240-20
 RU 3240-22
 RU 3240-24
 RU 3240-26

RU 3241-20
 RU 3241-22
 RU 3241-24
 RU 3241-26

RU 3242-20
 RU 3242-22
 RU 3242-24
 RU 3242-26

RU 3243-20
 RU 3243-22
 RU 3243-24
 RU 3243-26



Arterienklemmen, Aortaklemmen
Hemostatic Forceps, Aorta Clamps
Pinzas hemostáticas, Pinzas-clamps para aorta
Pinces hémostatiques, Pinces-clamps pour aortes
Pinze emostatiche, Pinze per aorta

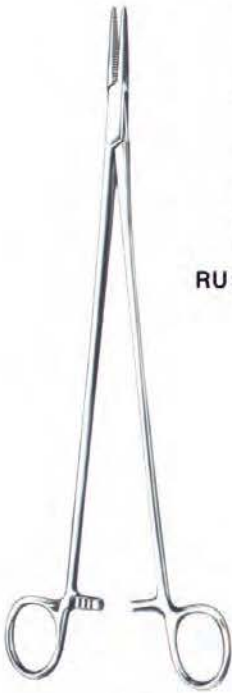

RU 3246-27

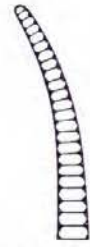

RU 3247-27

Bridge
27 cm/10 1/2"



RU 3270-24

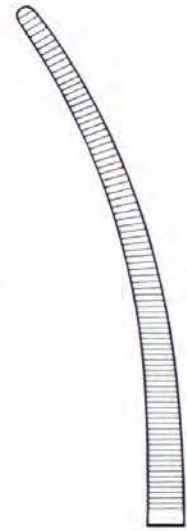

RU 3271-24

Sarot
24 cm/9 1/2"

Aortaklemmen
Aorta clamps
Pinzas-clamps para aorta
Pinces-clamps pour aortes
Pinze per aorta



22 cm/8 3/4"
RU 3274-22



23 cm/9"
RU 3274-23

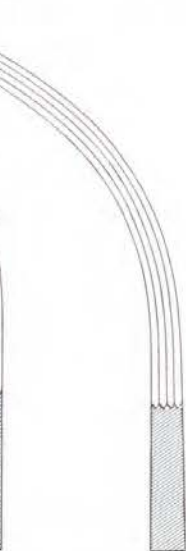

24 cm/9 1/2"
RU 3274-24



Crafoord-Sellors



18 cm/7"
RU 3275-18

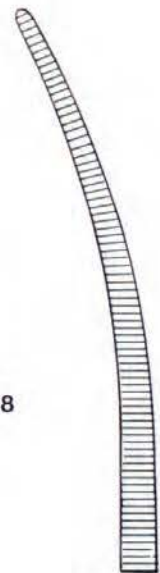

24 cm/9 1/2"
RU 3275-24
RU 3275-24 TI

Crafoord

TI = TITAN

Präparier- und Ligaturklemmen
Dissecting and Ligature Forceps
Pinzas para preparaciones y ligaduras
Pinces à disséquer et à ligatures
Pinze per dissezione e legature



Harrington

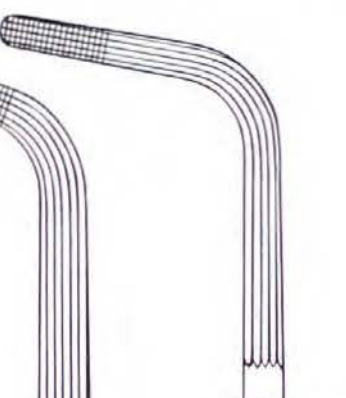

30,5 cm/12"
RU 3276-02

31 cm/12¼"
RU 3276-01



Kantrowitz

19 cm/7½"
24 cm/9½"
26,5 cm/10½"
RU 3279-19
RU 3279-24
RU 3279-26



Rumel
23 cm/9"

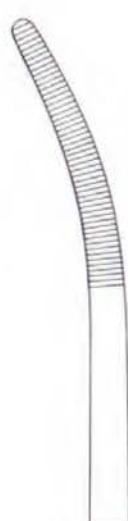

RU 3280-01



RU 3280-02

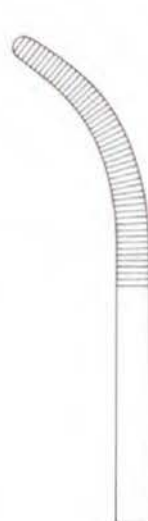

RU 3280-03

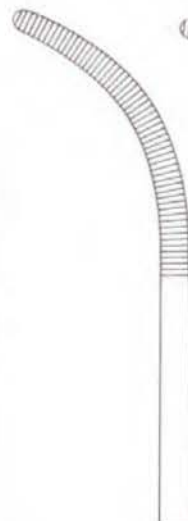

RU 3280-04

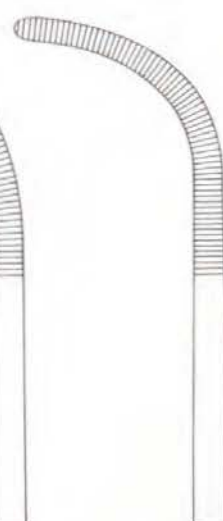

RU 3280-05



Präparier- und Ligaturklemmen
Dissecting and Ligature Forceps
Pinzas para preparaciones y ligaduras
Pinces à disséquer et à ligatures
Pinze per dissezione e legature



Overholt-S

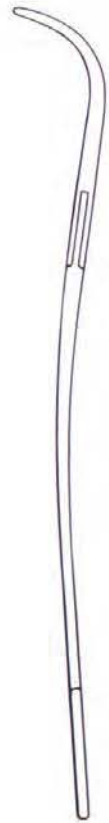
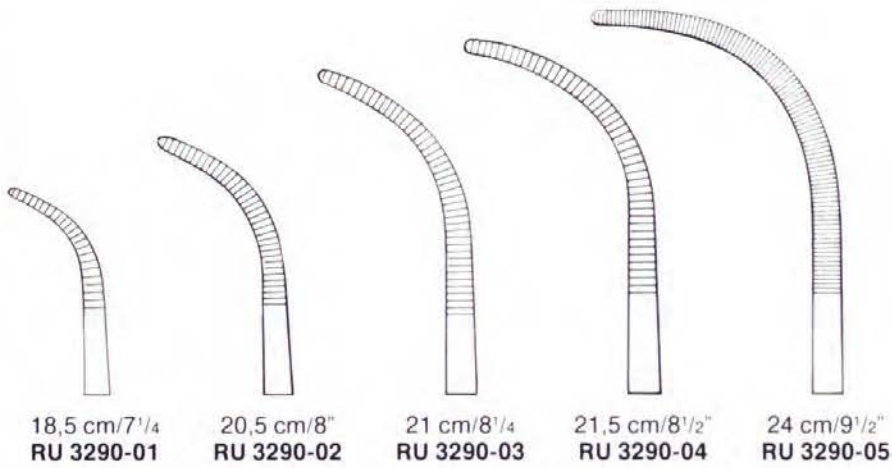

Overholt-Slim

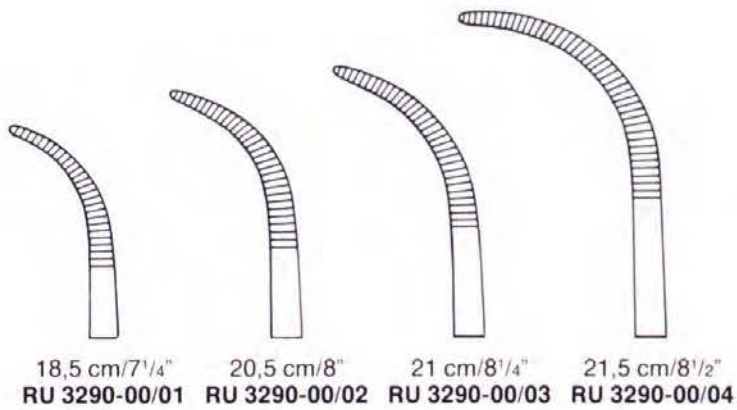

Präparier- und Ligaturklemmen
Dissecting and Ligature Forceps
Pinzas para preparaciones y ligaduras
Pinces à disséquer et à ligatures
Pinze per dissezione e legature



Overholt-Geissendörfer

21 cm/8 1/4"
27 cm/10 1/2"

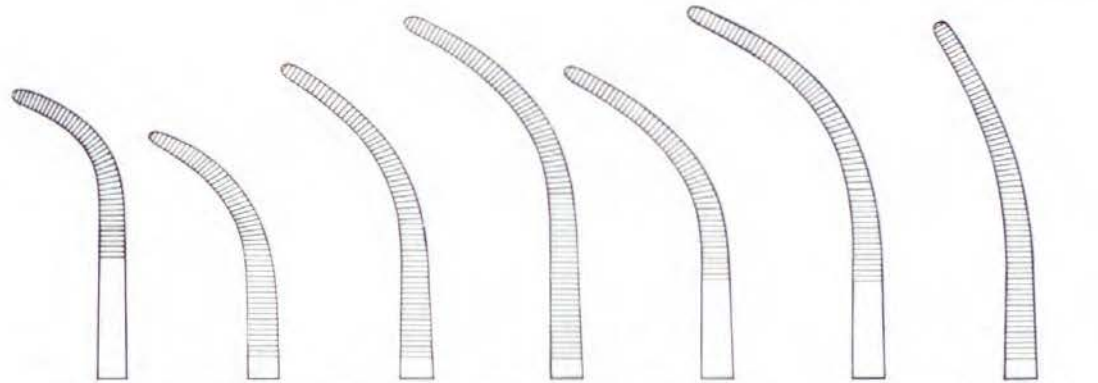

RU 3291-21 RU 3292-21 RU 3293-21 RU 3294-21 RU 3295-21 RU 3296-21 RU 3297-21
 RU 3291-27 RU 3292-27 RU 3293-27 RU 3294-27 RU 3295-27 RU 3296-27 RU 3297-27

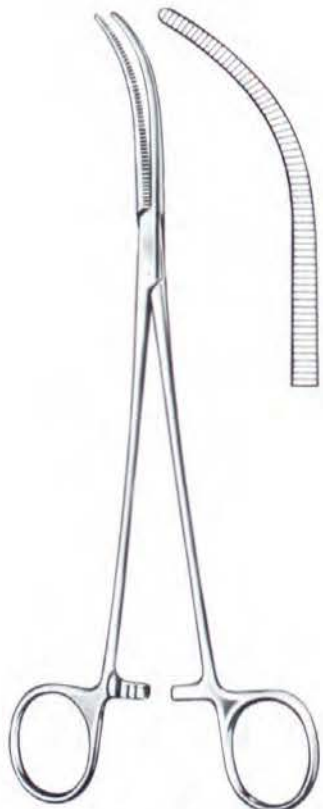

Overholt-Mixter
 21 cm/8 1/4"
 RU 3298-21

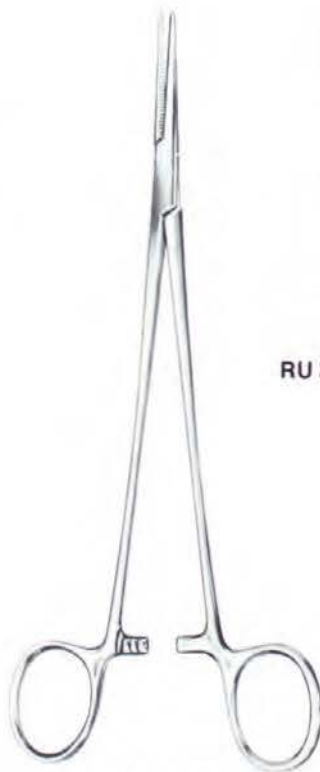

Heiss
 20 cm/8"

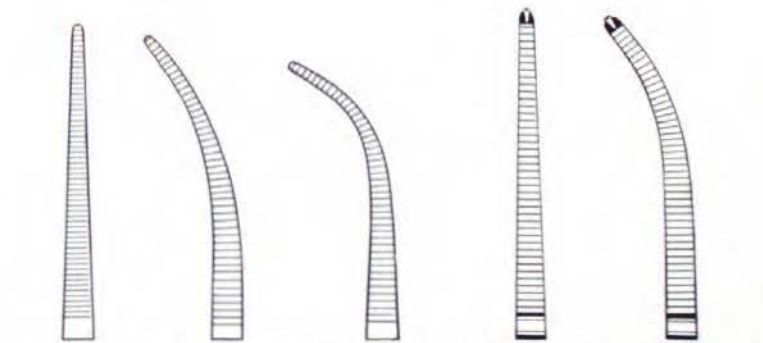

RU 3301-20 RU 3302-20 RU 3303-20 RU 3305-20 RU 3306-20



Präparier- und Ligaturklemmen
Dissecting and Ligature Forceps
Pinzas para preparaciones y ligaduras
Pinces à disséquer et à ligatures
Pinze per dissezione e legature



Gemini

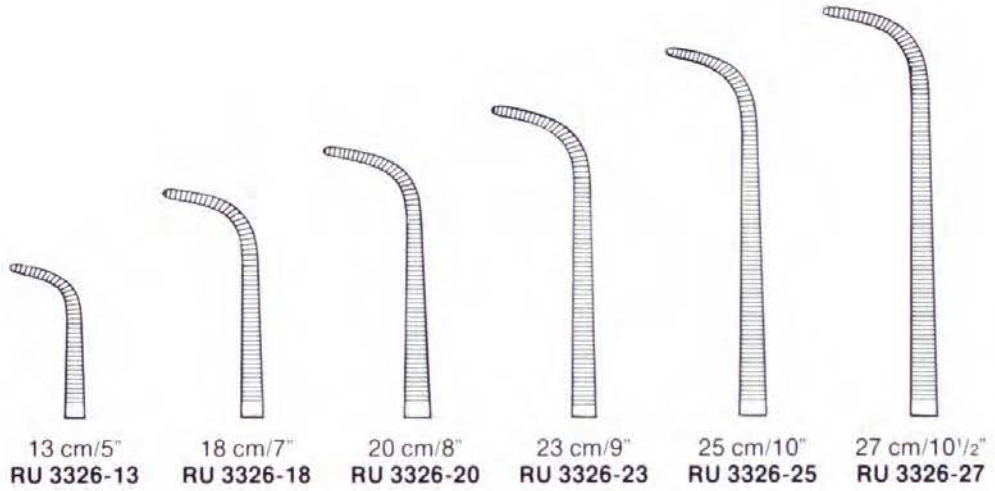

Mini-Gemini

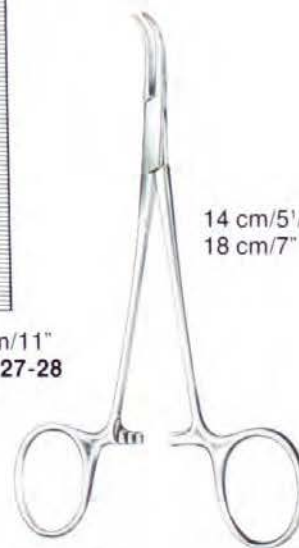
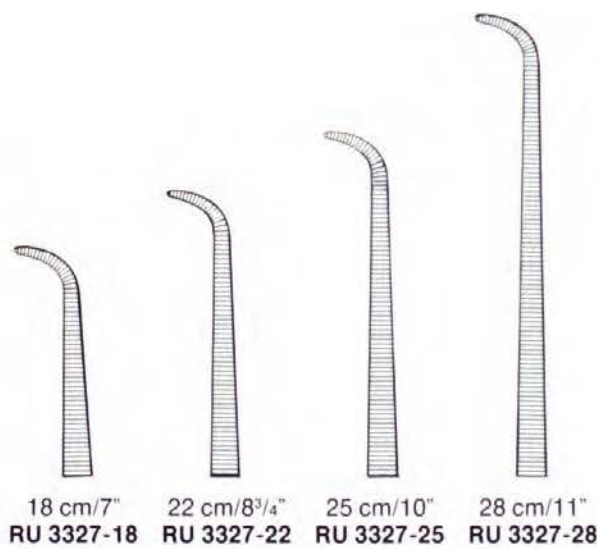

Baby-Mixer

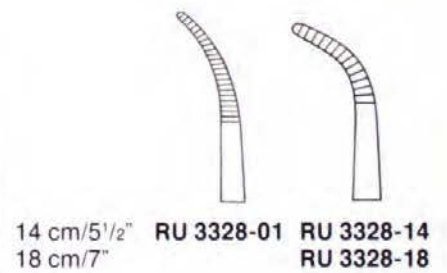

Präparier- und Ligaturklemmen
Dissecting and Ligature Forceps
Pinzas para preparaciones y ligaduras
Pinces à disséquer et à ligatures
Pinze per dissezione e legature



Koronar-Arterien-Präparierklemme
 Coronary artery dissecting clamp
 Pinzas para preparaciones de arterias coronarias
 Clamps à disséquer pour les artères coronaires
 Pinze per dissezione coronari



Sawtell
 18 cm/7"
 RU 3329-01



18,5 cm/7¼"
 RU 3329-11



Mixer O'Shaugnessy
 RU 3335-15 15,5 cm/6"
 RU 3335-19 19 cm/7½"



Mixer



22 cm/8¾"
 RU 3341-22

25 cm/10"
 RU 3342-25

28 cm/11"
 RU 3343-28



Mixer

22 cm/8¾"
 RU 3350-22



Präparier- und Ligaturklemmen
Dissecting and Ligature Forceps
Pinzas para preparaciones y ligaduras
Pinces à disséquer et à ligatures
Pinze per dissezione e legature

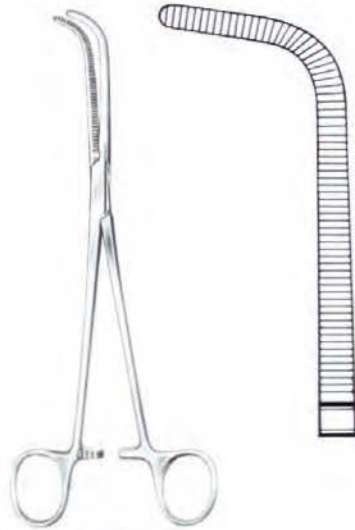

Wickstroem
20 cm/8"
RU 3351-20



Lawrence
27,5 cm/10¾"
RU 3355-27



Lahey (Sweet)



19 cm/7½"
RU 3361-19



23 cm/9"
RU 3361-23

Bulldogklemmen
Bulldog Clamps
Clamps Bulldog
Clamps Bulldog
Pinze Bulldog



Schwartz
 19 cm/7 1/2"
 RU 3930-80



2,7 cm/1"
 RU 3930-01



2,7 cm/1"
 RU 3930-02



2,5 cm/1"
 RU 3930-03



Federleichte Bulldogklemmen
 Featherlight Bulldog clamps
 Clamps Bulldog, ligeros como una pluma
 Clamps Bulldog poids plume
 Pinze Bulldog, ultra leggera



10 mm
 RU 3932-00



14 mm
 RU 3932-04



18 mm
 RU 3932-08

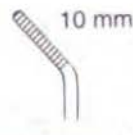

10 mm
 RU 3932-10

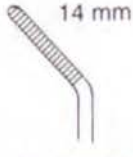

14 mm
 RU 3932-14



18 mm
 RU 3932-18

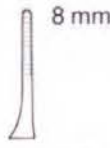

8 mm
 RU 3934-08



12 mm
 RU 3934-12



16 mm
 RU 3934-16



3,5 cm/1 1/2"
 RU 7586-10/35



3,5 cm/1 1/2"
 RU 7586-11/35



Diethrich

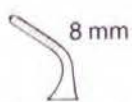

8 mm
 RU 3935-08

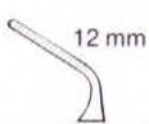

12 mm
 RU 3935-12



16 mm
 RU 3935-16

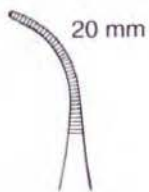

20 mm
 RU 3935-21



13 mm
 RU 3935-22

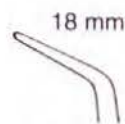

18 mm
 RU 3935-23



4,5 cm/1 3/4"
 RU 7586-10/45



4,5 cm/1 3/4"
 RU 7586-11/45



**Gefäßclips
Vessel Clips
Clips vasculares
Serre-fines
Serrafini**







Clip-Anlegezangen
Clip applying forceps
Pinzas para poner micro-clips
Pinces pour poser les serre-fines
Pinze per posizionare micro-clips



14 cm/5 1/2"
RU 3940-14



RU 3941-18 18 cm/7"
RU 3941-22 22 cm/8 3/4"

Maullänge length of jaw largo de boca longueur de mors lungh. del morso	Maulbreite width of jaw ancho de boca largeur de mors largh. del morso	Schließdruck occlusion pressure presión de oclusión pression d'occlusion pressione occlusiva				
			gerade straight rectos droites rette	leicht gebogen slightly curved curvos ligeros courbure légère curva leggera	stark gebogen strong curved curvos fuertes courbure forte curva forte	abgewinkelt angled acodados coudé angolate
4 mm	0,75 mm	125 g	RU 3950-04			
6 mm	1,00 mm	100 g	RU 3950-06			
8 mm	2,00 mm	85 g	RU 3950-08			
10 mm	2,00 mm	60 g	RU 3950-10			
4 mm	0,75 mm	150 g	RU 3955-04			
6 mm	1,00 mm	150 g	RU 3955-06	RU 3956-06	RU 3957-06	RU 3958-06
8 mm	2,00 mm	150 g	RU 3955-08			
10 mm	2,00 mm	150 g	RU 3955-10			
4 mm	0,75 mm	70 g	RU 3960-04			
6 mm	0,80 mm	70 g	RU 3960-06			
6 mm	1,00 mm	70 g	RU 3960-07	RU 3966-06	RU 3967-06	RU 3968-06
8 mm	1,00 mm	70 g	RU 3960-08			
10 mm	1,50 mm	70 g	RU 3960-10			

Mikro-Gefäßklemmen Micro Vascular Clamps Micro-clamps vasculares Micro-clamps vasculaires Micro clips vascolari



Anlegepinzette für Mikro-Gefäßklemmen RU 3975-396 bis RU 3975-478
 Applying forceps for micro vascular clamps RU 3975-396 to RU 3975-478
 Pinzas para aplicar micro-clamps vasculares RU 3975-396 a RU 3975-478
 Pince à poser les micro-clamps vasculaires RU 3975-396 à RU 3975-478
 Pinze per posizionare i micro-clips RU 3975-396 a RU 3975-478



14 cm/5½"

mit Sperre
with ratchet
con cierre
avec verrou
con cremagliera
RU 3975-071

ohne Sperre
without ratchet
sin cierre
sans verrou
senza cremagliera
RU 3975-072

V = für Venen
for veins
para venas
pour des veines
per vene

A = für Arterien
for arteries
para arterias
pour des artères
per arterie

ACLAND, mod.



Gefäßgröße Vessel size Tamaño de vaso Grandeur des vaisseaux Lunghezza del vaso	Einzelklemmen (Paar)		Approximatoren ohne Rahmen, beweglich		Doppelklemmen mit Rahmen		Approximatoren mit Rahmen, beweglich	
	V	A	V	A	V	A	V	A
0,4–1,0 mm	RU 3975-396	RU 3975-397	RU 3975-414	RU 3975-415	RU 3975-402	RU 3975-403	RU 3975-408	RU 3975-409
0,6–1,5 mm	RU 3975-398	RU 3975-399	RU 3975-416	RU 3975-417	RU 3975-404	RU 3975-405	RU 3975-410	RU 3975-411
1,0–2,25 mm	RU 3975-400	RU 3975-401	RU 3975-418	RU 3975-419	RU 3975-406	RU 3975-407	RU 3975-412	RU 3975-413
1,5–3,5 mm	RU 3975-325		RU 3975-326					
2,0–5,0 mm	RU 3975-286		RU 3975-287					
Schwarz/black negro/noir/nero								
0,4–1,0 mm	RU 3975-462	RU 3975-461	RU 3975-480	RU 3975-479	RU 3975-468	RU 3975-467	RU 3975-474	RU 3975-473
0,6–1,5 mm	RU 3975-464	RU 3975-463	RU 3975-482	RU 3975-481	RU 3975-470	RU 3975-469	RU 3975-476	RU 3975-475
1,0–2,25 mm	RU 3975-466	RU 3975-465	RU 3975-484	RU 3975-483	RU 3975-472	RU 3975-471	RU 3975-478	RU 3975-477
1,5–3,5 mm	RU 3975-329		RU 3975-330					
2,0–5,0 mm	RU 3975-327		RU 3975-328					



Mikro-Gefäßclips
Micro Vessel Clips
Micro-clips vasculares
Micro-serre-fines
Micro-serrafini



Temporäre Gefäßclips mit atraumatischem Maulprofil
 Non-traumatic vessel clips, temporary
 Clips vasculares atraumaticos, temporarios
 Serre-fines atraumatiques, temporaires
 Serrafini cardiovascolare atraumatiche, temporaneo



Müller 50 g **RU 3977-010** **RU 3977-011** **RU 3977-012** **RU 3977-013** **RU 3977-014**
 80 g **RU 3977-020** **RU 3977-021** **RU 3977-022** **RU 3977-023** **RU 3977-024**

Anlegepinzette
 Applying forceps
 Pinzas para poner micro-clips
 Pince à poser les clips
 Pinze per posizionare micro clips



15 cm/6"
RU 3977-078

	Maullänge length of jaw largo de boca longueur de mors lunghezza del morso	Maulbreite width of jaw ancho de boca largeur de mors larghezza del morso	Schließdruck occlusion pressure presión de oclusión pression d'occlusion pressione occlusiva	Artikelnummer Reference no. Referencia No. Référence No d'articolo
	4 mm	1 mm	10 – 15 g	RU 3977-052
	4 mm	1,4 mm	15 – 20 g	RU 3977-054
	6 mm	1 mm	10 – 15 g	RU 3977-056
	6 mm	1,4 mm	15 – 20 g	RU 3977-058

Mikro-Gefäßclips und Approximatoren
Micro Vessel Clips and Approximators
Micro-clips vasculares y aproximadores
Micro-serre-fines et approximateurs
Micro-serrafini ed approssimatori



Biemer Mikro-Gefäßclips Micro vessel clips Micro-clips vasculares Micro-serre-fines Micro-serrafini	Maullänge length of jaw largo de boca longueur de mors lungh. del morso	Maulbreite width of jaw ancho de boca largeur de mors largh. del morso	Schließdruck occlusion pressure presión de oclusión pression d'occlusion pressione occlusiva	Artikelnummer Reference no. Referencia No. Référence No d'articolo
	6 mm	4 mm	30 – 40 g	RU 3977-060
	9 mm	5 mm	30 – 40 g	RU 3977-061
	9 mm	5 mm	20 – 25 g	RU 3977-062

Biemer-Müller Mikro-Approximatoren Micro approximators Micro-aproximadores Micro approximateurs Micro-approssimatori				
	9 mm	5 mm	25 – 30 g	RU 3977-111
	9 mm	5 mm	25 – 30 g	RU 3977-112
	9 mm	5 mm	25 – 30 g	RU 3977-113
	9 mm	5 mm	25 – 30 g	RU 3977-114
	4,5 mm	3 mm	25 – 30 g	RU 3977-115

Müller Approximatoren mit 3/8 Kreis-Maulbogen für feste Rundkörper Approximators with 3/8 jaw curve for solid trunks Aproximadores con círculo de boca 3/8 para cuerpos redondos Approximateurs avec mors 3/8 cercle pour des corps ronds Approssimatori con morsi 3/8 cerchio per corpi rotondi				
	Ø 1 mm		25 – 30 g	RU 3977-171
	2 mm		25 – 30 g	RU 3977-172
	3 mm		25 – 30 g	RU 3977-173
	4 mm		25 – 30 g	RU 3977-174



14 cm/5½"
ohne Schloß
without catch
sin cierre
sans arrêt
senza cremagliera
RU 3977-068

mit Schloß
with catch
con cierre
avec arrêt
con cremagliera
RU 3977-069



Pinzetten
Dissecting Forceps
Pinzas de disección
Pinces à disséquer
Pinze anatomiche

 **Rudolf**
MEDICAL

Atrauma-Pinzetten siehe Seite 113, 114
Atraumatic dissecting forceps see page 113, 114
Atrauma pinzas de disección ver página 113, 114
Pinces à disséquer atraumatiques voir page 113, 114
Pinze atraumatiche, vedere pagina 113, 114





Mikro-Grip Pinzetten
Micro Grip Forceps
Micro-Grip Pinzas de disección
Pinces à disséquer Micro-Grip
Pinze Micro-Grip



Rudolf
MIKRO-GRIP



gerade
 straight
 rectas
 droits
 rette



gebogen
 curved
 curvas
 courbes
 curve



Ringpinzetten
 Ring forceps
 Pinzas de anillo
 Pinces annulaires
 Pinze micro con anelli

15 cm/6"	RU 4068-51	RU 4068-52
18 cm/7"	RU 4068-53	RU 4068-54
21 cm/8¼"	RU 4068-55	RU 4068-56

17,5 cm/7"	RU 4068-57
21 cm/8¼"	RU 4068-58



Ima
 18 cm/7"
RU 4068-63
RU 4068-63 TI



Adson
 12 cm/4¾"
RU 4068-71



McIndoe
 15 cm/6"
RU 4068-72

TI = TITAN



Anatomische Pinzetten, Mikro-Pinzetten
Dressing Forceps, Micro Forceps
Pinzas de disección, Micro-pinzas
Pinces à disséquer, Micro-pinces
Pinze anatomiche, Micro-Pinze



Rudolf
TC



Rudolf
TC



Standard
 14,5 cm/5¾"
 16,0 cm/6¼"
 18,0 cm/7"
 20,0 cm/8"
 25,0 cm/10"

RU 4002-14
RU 4002-16
RU 4002-18
RU 4002-20
RU 4002-25

Adson Standard
 12 cm/4¾"
RU 4035-12
RU 4035-12 TI

Adson
 12 cm/4¾" **RU 4036-12**
 15 cm/6" **RU 4036-15**

McIndoe
 15 cm/6"
RU 4038-15
RU 4038-15 TI



gebogen
 curved
 curvas
 courbes
 curve



Gerald

cm	in				
12,0	4¾			RU 4068-12	RU 4069-12
13,0	5		RU 4066-13	RU 4067-13	
15,0	6	RU 4065-15		RU 4068-15	RU 4069-15
17,5	7				RU 4070-17 RU 4070-17 TI
18,0	7	RU 4065-18		RU 4068-18	RU 4069-18

TI = TITAN



Mikro-Pinzetten, Tumorfaßpinzetten
Micro Forceps, Tumor Grasping Forceps
Micro-pinzas, Pinzas para tumores
Micro-pinces, Pinces pour tumeurs
Micro-pinze, Pinze per tumore



Rudolf
TITAN



18 cm/7"



0,4 mm
RU 4062-18/04 TI



0,8 mm
RU 4062-18/08 TI



0,4 mm
RU 4063-18/04 TI



0,8 mm
RU 4063-18/08 TI



6 x 0,4 mm
RU 4068-18/04 TI



6 x 0,8 mm
RU 4068-18/08 TI



6 x 0,4 mm
RU 4069-18/04 TI



6 x 0,8 mm
RU 4069-18/08 TI



6 x 0,4 mm
RU 4086-18/04 TI



6 x 0,8 mm
RU 4086-18/08 TI



6 x 0,4 mm
RU 4087-18/04 TI



6 x 0,8 mm
RU 4087-18/08 TI



18 cm/7"



1 x 0,5 mm
RU 4079-18/01 TI

2 x 1,0 mm

RU 4079-18/03 TI



1 x 0,5 mm
RU 4079-18/02 TI

2 x 1,0 mm

RU 4079-18/04 TI

TI = TITAN



**Anatomische Pinzetten Mikro-Knüpfpinzetten, Faßpinzetten
 Dressing Forceps, Micro Suture Tying Forceps, Grasping Forceps
 Pinzas de disección, Micro-pinzas para sutura, Pinzas para coger
 Pincers à disséquer, Micro-pincers à sutures, Pincers à saisir
 Pinze anatomiche, Micro-pinze per sutura, Pinze per afferrare tessuti**

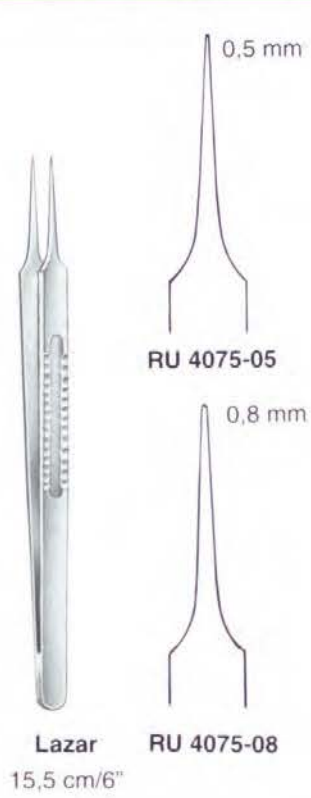
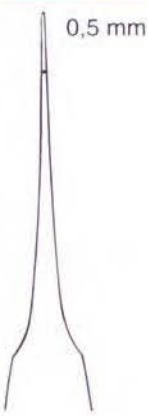

cm	in			
15	6		Wangenstein	Potts-Smith
18	7	RU 4083-17	RU 4085-15	RU 4092-15
20	8			RU 4092-18
23	9		RU 4085-23	RU 4092-20
25	10		RU 4085-25	RU 4092-23
				RU 4092-25



Chirurgische Pinzetten, Lungenfaßpinzetten
Tissue Forceps, Lung Grasping Forceps
Pinzas de disección con dientes, Pinzas para coger pulmones
Pinces à griffes, Pinces à saisir les poumons
Pinze chirurgiche a denti di topo, Pinze per polmone



1:2



Adson

12 cm/4¾"

RU 4135-12

RU 4135-12 TI

1:2



Adson

12 cm/4¾"

RU 4136-12

1:2



Adson-Brown

12 cm/4¾"

RU 4137-12

RU 4137-12 TI

1:2



Gillies

15 cm/6"

RU 4138-15

RU 4138-15 TI



Gerald

18 cm/7"

RU 4170-18

RU 4170-18 TI

TI = TITAN

Lungen- und Gewebefaßzangen
 Lung and tissue grasping forceps
 Pinzas para coger pulmones y tejidos
 Pinces à saisir les poumons et la tissue
 Pinze per polmone e pinze per afferrare tessuti



Mayo

23 cm/9"

RU 4221-23

Lungenfaßpinzetten
 Lung grasping forceps
 Pinzas para coger pulmones
 Pinces à saisir les poumons
 Pinze per polmone



Nelson

23 cm/9"

RU 4235-23



Singley-Tuttle

23 cm/9"

RU 4236-23

Wundhaken, Wundsperrer
Retractors, Self-retaining Retractors
Separadores y ganchos, Separadores
Ecarteurs et crochets
Divaricatori ed Uncini

 **rudolf**
MEDICAL

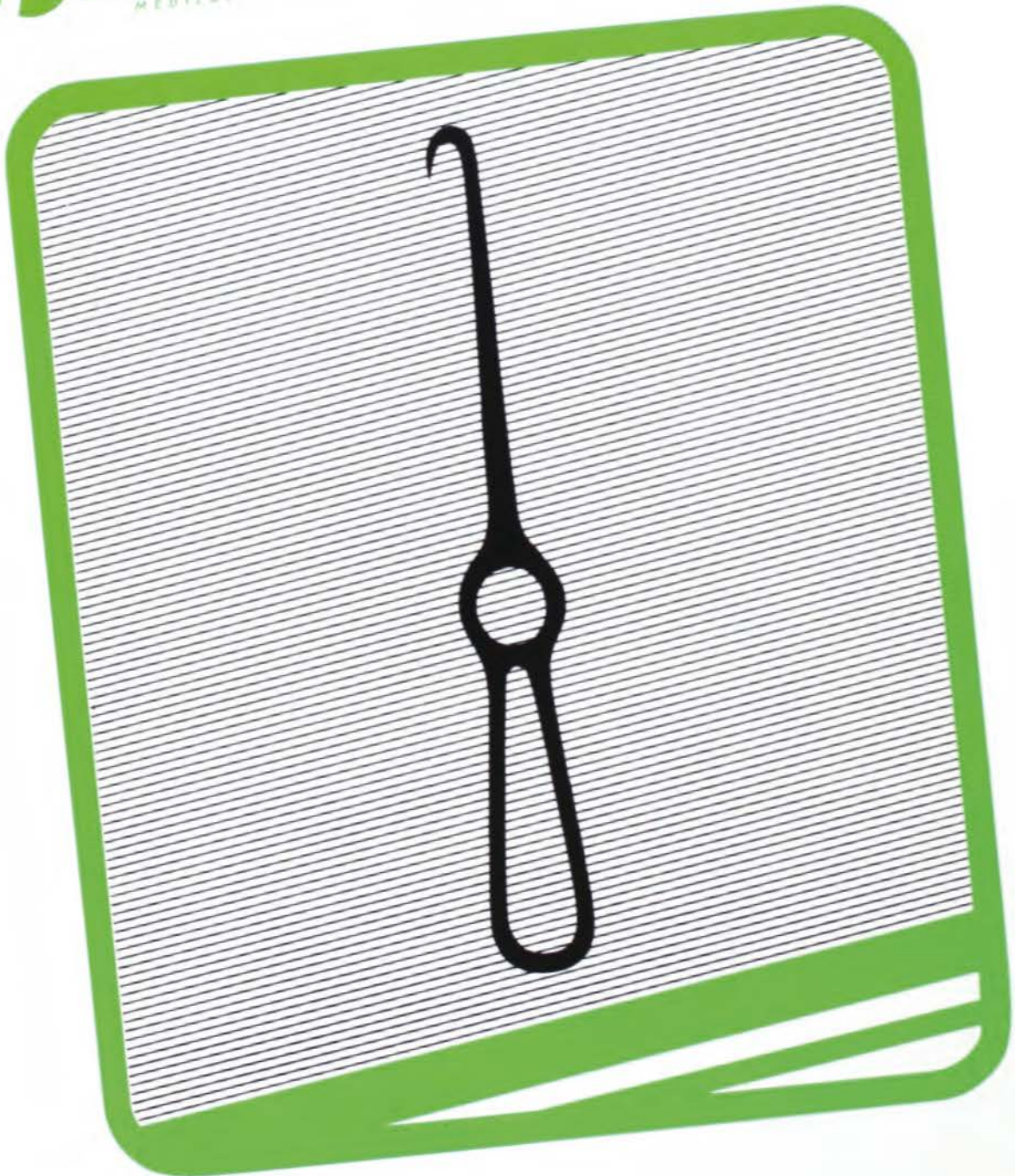



Gefäß- und Wundhäkchen
Vessel and Wound Retractors
Ganchos, Ganchos vasculares
Crochets à veines, Crochets fins
Divaricatori, Uncini vascolari



biegsam
flexible
maleables
malléables
malleabili



Gil-Vernet
24 cm/9 1/2"

12x14 mm



Little
20 cm/8"
RU 4455-20



Love (Morse)
25 cm/10"

- 10 mm RU 4456-10
- 15 mm RU 4456-15
- 20 mm RU 4456-20
- 30 mm RU 4456-30
- 40 mm RU 4456-40
- 50 mm RU 4456-50



Cushing
25 cm/10"



11 x 14 mm
RU 4456-81



13 x 18 mm
RU 4456-82



15 x 22 mm
RU 4456-83

8 mm	RU 4449-08
11 mm	RU 4449-11
15 mm	RU 4449-15
17 mm	RU 4449-17
20 mm	RU 4449-20
23 mm	RU 4449-23

Gefäß- und Wundhäkchen
 Vessel and Wound Retractors
 Ganchos, Ganchos vasculares
 Crochets à veines, Crochets fins
 Divaricatori, Uncini vascolari





Wundhaken, Knochenhaken
Retractors, Bone Retractors
Separadores, Separadores para huesos
Crochets, Ecarteurs à os
Divaricatori, Divaricatori ossea



scharf
sharp
agudo
pointu
acuto

Volkman
22 cm/8³/₄"
RU 4500-01



stumpf
blunt
romo
mousse
smusso

Volkman
22 cm/8³/₄"
RU 4501-01



scharf
sharp
agudo
pointu
acuto

24 cm/9¹/₂"
RU 4506-24



55 x 20 mm
RU 4522-01
63 x 20 mm
RU 4522-02
60 x 20 mm
RU 4522-05

Langenbeck
21 cm/8¹/₄"



19 x 12 mm
RU 4536-01
21 x 15 mm
RU 4536-02

Kocher
19 cm/7¹/₂"

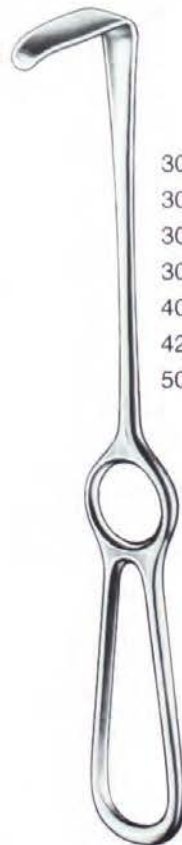

30 x 11 mm RU 4530-01
30 x 14 mm RU 4530-02
30 x 14 mm RU 4530-03
30 x 16 mm RU 4530-04
40 x 11 mm RU 4530-05
42 x 13 mm RU 4530-06
50 x 11 mm RU 4530-07

Langenbeck
21 cm/8¹/₄"



25 x 6 mm RU 4538-11
25 x 8 mm RU 4538-12
35 x 8 mm RU 4538-13
35 x 11 mm RU 4538-14
35 x 15 mm RU 4538-15
40 x 11 mm RU 4538-16
55 x 11 mm RU 4538-17
70 x 14 mm RU 4538-18
80 x 12 mm RU 4538-19
80 x 16 mm RU 4538-20

Kocher-Langenbeck
21,5 cm/8¹/₂"

Wundhaken
Retractors
Separadores
Ecarteurs
Divaricatori



Crawford
19 cm/7½"



15 x 15 mm
RU 4547-01

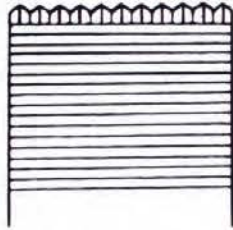

15 x 23 mm
RU 4547-02



Simon
28 cm/11"

115 x 22 mm
RU 4560-01
115 x 27 mm
RU 4560-02



Martin
26 cm/10¼"

105 x 27 mm



Mikulicz
26 cm/10¼"

85 x 35 mm
RU 4565-01
120 x 50 mm
RU 4565-02
155 x 50 mm
RU 4565-03



Kelly
27 cm/10½"

160 x 38 mm
RU 4567-01
160 x 57 mm
RU 4567-02
190 x 38 mm
RU 4567-51
190 x 57 mm
RU 4567-52



Wundhaken, Lungenspatel
 Retractors, Lung Spatulas
 Separadores, Espátulas pulmonares
 Ecarteurs, Spatules pulmonaires
 Divaricatori, Spatole per polmone



115 × 65 mm
 RU 4568-03

115 × 38 mm
 RU 4568-02

82 × 20 mm
 RU 4568-01

Coryllos
 22,5 cm/9"



130 × 38 mm
 RU 4569-25

Sauerbruch
 25 cm/10"



19 mm

22 mm

25 mm

25 mm

38 mm
 RU 4570-07
 50 mm
 RU 4570-08
 75 mm
 RU 4570-09

Deaver
 18 cm/7"
 RU 4570-01

Deaver
 21,5/8 1/2"
 RU 4570-02

Deaver
 23 cm/9"
 RU 4570-03

Deaver
 30 cm/12" RU 4570-04
 33 cm/13" RU 4570-05
 36 cm/14" RU 4570-06

Deaver
 30 cm/12"

Wundhaken, Lungenspatel
 Retractors, Lung Spatulas
 Separadores, Espátulas pulmonares
 Ecarteurs, Spatules pulmonaires
 Divaricatori, Spatole per polmone



25 mm RU 4571-04
 38 mm RU 4571-07
 50 mm RU 4571-08
 75 mm RU 4571-09

Deaver Grip-Handle
 30 cm/12"



Harrington-Baby
 25 cm/10"
 24 x 70 mm RU 4572-00

Harrington
 32 cm/12¹/₂"
 40 x 127 mm RU 4572-01
 62 x 127 mm RU 4572-02

Harrington-Pemberton
 29,5 cm/11,5"
 64 x 175 mm RU 4572-51



Zenker

25 cm/10"	35 x 8 mm	RU 4574-01
26 cm/10 ¹ / ₄ "	60 x 12 mm	RU 4574-02
27,5 cm/10 ³ / ₄ "	75 x 12 mm	RU 4574-03
29 cm/11 ¹ / ₂ "	120 x 12 mm	RU 4574-04



20 mm
 RU 4578-20
 30 mm
 RU 4578-30
 40 mm
 RU 4578-40

Kader
 27 cm/10³/₄"



Wundhaken, Lungenspatel, Atriumhaken, Aortenklappenhaken
 Retractors, Lung Spatulas, Atrium Retractors, Aorta Valve Retractors
 Separadores, Espátulas pulmonares, Separadores para aurícula, Ganchos para aorta
 Ecarteurs, Spatules pulmonaires, Ecarteurs pour auricules cardiaques, Crochets aortiques
 Divaricatori, Spatole per polmone, Divaricatori auricolare, Divaricatori per aorta



Atriumhaken
 Atrium retractors
 Separadores para aurícula
 Ecarteurs pour auricules cardiaques
 Divaricatori auricolare

rechts, leicht gezahnt
 right, slightly serrated
 a la derecha, ligeramente dentado
 à droite, légèrement dentelé
 destra, dentellate leggermente

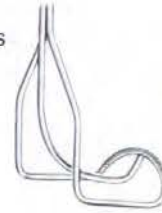

Cooley

21,5 cm/8½"
 RU 4591-02

links
 left
 a la izquierda
 à gauche
 sinistra

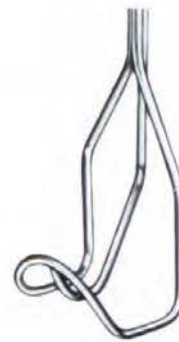

Cooley

23 cm/9"
 RU 4591-03



Davidson
 16 cm/6¼"

75 x 50 mm
 75 x 90 mm

RU 4590-01
RU 4590-02



rechts
 right
 a la derecha
 à droite
 destra

Cooley

21,5 cm/8½"
 RU 4591-01



Ross
 24,5 cm/9½"

Aortenklappenhaken
 Aorta valve retractors
 Ganchos para aorta
 Crochets aortiques
 Divaricatori per aorta

Fig. 1 15 x 16 mm **RU 4593-01**
 Fig. 2 13 x 23 mm **RU 4593-02**
 Fig. 3 17 x 23 mm **RU 4593-03**
 Fig. 4 13 x 27 mm **RU 4593-04**
 Fig. 5 29 x 29 mm **RU 4593-05**
 Fig. 6 40 x 21 mm **RU 4593-06**

Schaft biegsam
 flexible shaft
 Vástago maleable
 tige malléable
 Asta malleabile

17 x 21 mm **RU 4593-21**
 16 x 23 mm **RU 4593-22**
 20 x 25 mm **RU 4593-23**
 24 x 27 mm **RU 4593-24**
 28 x 20 mm **RU 4593-25**
 28 x 29 mm **RU 4593-26**



Borowski
 27 cm/10½"





Alm

scharf · sharp stumpf · blunt
agudos · pointus romos · mousses
acuti smussi

cm	in		
7	2 ³ / ₄	RU 4650-07	RU 4651-07
10	4	RU 4650-10	RU 4651-10



Weitlaner

scharf stumpf
sharp blunt
agudos romos
pointus mousses
acuti smussi



**Cone
(Adson-Baby)**

scharf stumpf
sharp blunt
agudos romos
pointus mousses
acuti smussi



Adson

33 cm/13"
RU 4743-33

13 cm/5" **RU 4700-13** **RU 4701-13**
16 cm/6¹/₄" **RU 4700-16** **RU 4701-16**

RU 4722-13 **RU 4723-13**
RU 4722-16 **RU 4723-16**



Wundhaken, Lungen spatel
Retractors, Lung Spatulas
Separadores, Espátulas pulmonares
Ecarteurs, Spatules pulmonaires
Divaricatori, Spatole per polmone



3 x 4 Zähne
 3 x 4 teeth
 3 x 4 dientes
 3 x 4 dents
 3 x 4 denti

scharf stumpf
 sharp blunt
 agudos romos
 pointus mousses
 acuti smussi

20 cm/8" **RU 4724-20** **RU 4725-20**
 25 cm/9 1/2" **RU 4724-25** **RU 4725-25**

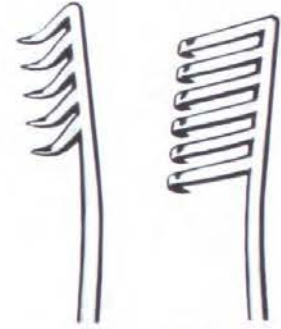

5 x 6 Zähne
 5 x 6 teeth
 5 x 6 dientes
 5 x 6 dents
 5 x 6 denti

scharf stumpf
 sharp blunt
 agudo romo
 pointu mousse
 acuti smussi

RU 4726-25 **RU 4727-25**



Lungenspatel
 Lung spatulas
 Espátulas pulmonares
 Spatules pulmonaires
 Spatole per polmone

Allison
 25,5 cm/10" **RU 7538-25**
 30 cm/12" **RU 7538-30**

Gefäßinstrumente
Vessel Instruments
Instrumental vascular
Instruments pour vaisseaux
Strumenti vascolari

 **rudolf**
MEDICAL

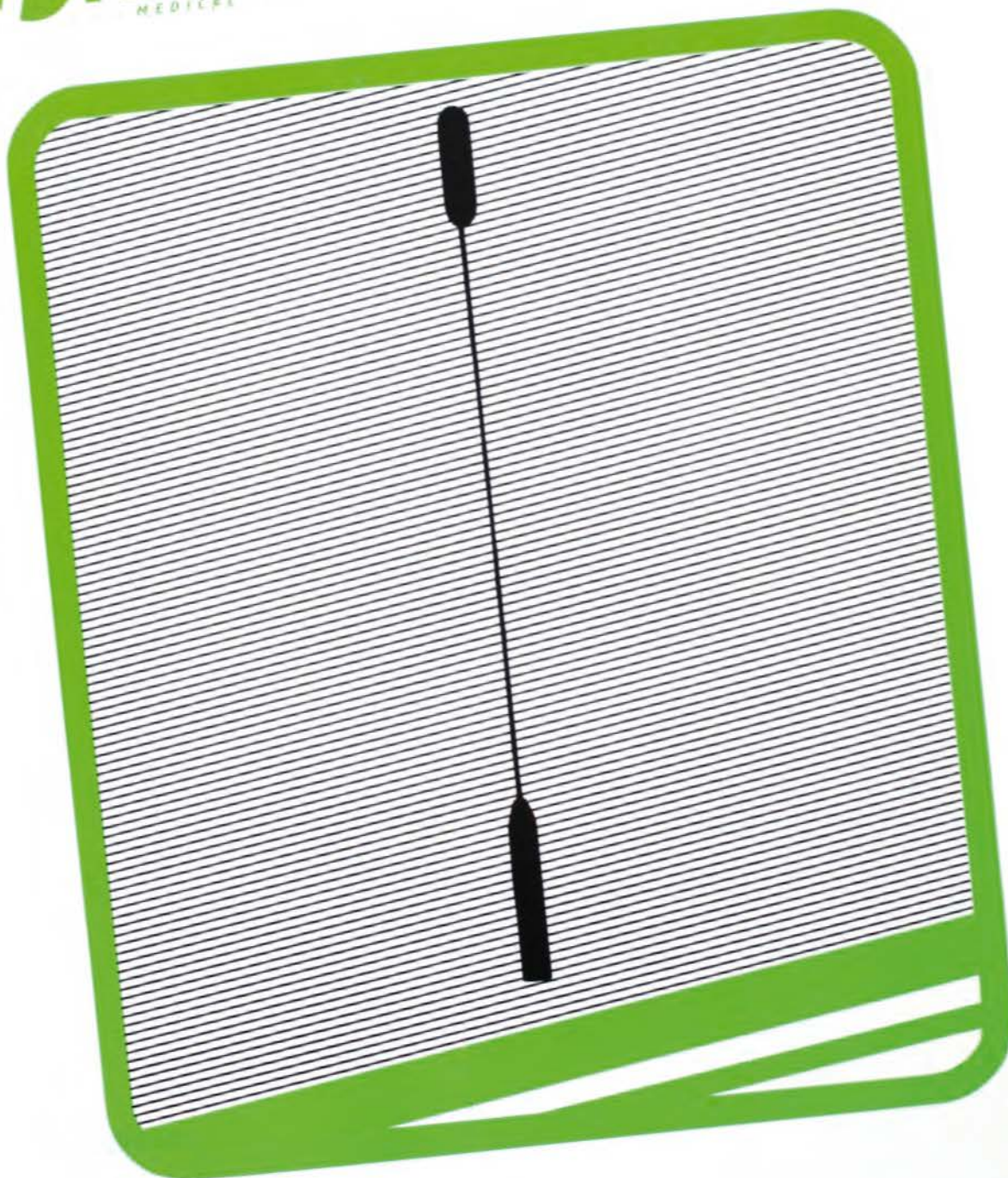



**Venenstripper-Besteck, Venenstripper
Vein Stripper Set, Vein Strippers
Juego para várices, Sondas para várices
Trousse à veines, Cordes veineuses
Astuccio per le vene, Sonde per vene**



Venenstripper-Besteck in Metalletui
Vein stripper set in metal case
Juego para várices en estuche de metal
Trousse à veines en boîte métallique
Astuccio per le vene in scatola in metallo

Ersatzteile für RU 4950-00
Spare parts for RU 4950-00
Piezas de repuesto
Pièces de rechange pour RU 4950-00
Pezzi di ricambio



sterilisierbar
sterilizable
esterilizable
stérilisable
sterilizzabile

Nabatoff
135 x 100 x 25 mm
RU 4950-00

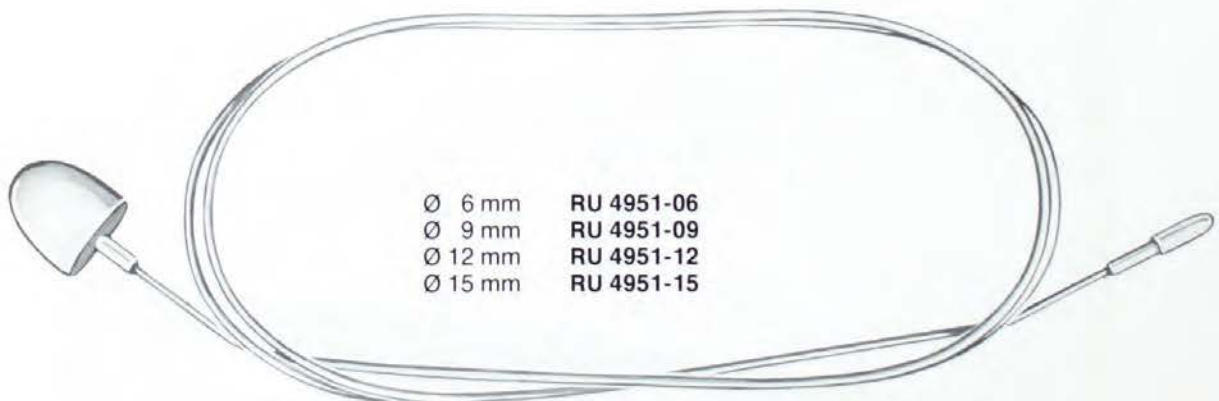

Myers

Endarterektomie, Varizeninstrumente
Endarterectomy, Varix Instruments
Endarterectomia, Instrumental para várices
Endartérectomie, Instruments pour les varices
Endarterectomia, Strumenti per varici



Endarterektomiestripper
 Endarterectomy strippers
 Sondas para endarterectomia
 Sondes pour endartérectomie
 Sonde per endarterectomia



Ø
mm

- | | | |
|-----|-------------------|-------------------------------------|
| 2 | RU 4952-02 | Gefäß-Spülkanülen |
| 3 | RU 4952-03 | Vessel irrigating cannulas |
| 4 | RU 4952-04 | Cánulas de irrigación para vasos |
| 6 | RU 4952-06 | Canulas de irrigación para vasos |
| 7 | RU 4952-07 | Canules d'irrigation pour vaisseaux |
| 8,5 | RU 4952-08 | Canules d'irrigation pour vaisseaux |
| 10 | RU 4952-10 | Canule per irrigazione per varici |
| 12 | RU 4952-12 | |
| 14 | RU 4952-14 | |



Griff für
 Handle for
 Mango para
 Manche pour
 Manico per

RU 4952-02 – RU 4952-14

RU 4952-00

55 cm/21½"



Schmid

Ø 3 mm

Ø 4 mm



RU 4954-03



RU 4954-04

Ø 5 mm

Ø 6 mm



RU 4954-05



RU 4954-06

Phlebodissektor
 Phlebodissector
 Disector para venas
 Phlébo-dissecteur
 Flebo-dissettori

Phlebextraktoren
 Phlebextractors
 Extractores para venas
 Phlébo-extracteurs
 Flebe-estrattore

Mikro-Doppelspatel
 Micro spatula
 Micro-espátulas
 Micro-spatules
 Micro-spatole doppie

Mikro-Phlebextraktor
 Micro phlebextractor
 Micro-extractores para venas
 Micro-phlébo-extracteurs
 Micro-flebo-estrattore

Mini-Phlebextraktor
 Mini phlebextractor
 Mini-extractores para venas
 Mini-phlébo-extracteurs
 Mini-flebo-estrattore



Varady

18 cm/7"
RU 4956-01



Varady

18 cm/7"
RU 4956-02



Varady

18 cm/7"
RU 4956-03



Varady

17 cm/6¾"
RU 4956-04



Varady

17 cm/6¾"
RU 4956-05



Varady

17 cm/6¾"
RU 4956-06



Gefäßspatel
Vessel Spatulas
Espátulas vasculares
Spatules pour les vaisseaux
Spatole vascolari



Schmid

14 cm/5½"
RU 4955-03/14

24 cm/9¼"
RU 4955-03/24



23 cm/9"
RU 4955-05/23



15 cm/6"
RU 4955-10/15

21 cm/8¼"
RU 4955-10/21



Davis
24,5 cm/9¾"
RU 6342-24



Rechtshänder
Right-handed
Para diestros
Pour droitier
Per destrimani

Set à 3 Haken
Set of 3 hooks
Set de 3 ganchos
Set de 3 crockets
Set di 3 uncini
RU 4956-21, -22, -23



Linkshänder
Left-handed
Para zurdos
Pour gaucher
Per mancini

Set à 3 Haken
Set of 3 hooks
Set de 3 ganchos
Set de 3 crockets
Set di 3 uncini
RU 4956-31, -32, -33

RU 4956-20

RU 4956-30



Toennis
25 cm/10"

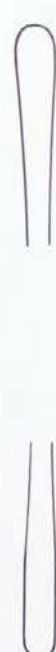

RU 6344-25

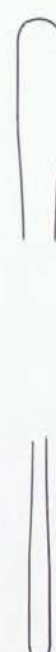

RU 6344-25/01



Freer
18 cm/7"
RU 8216-18



Halle
 16,5 cm/6½"
 RU 8204-16

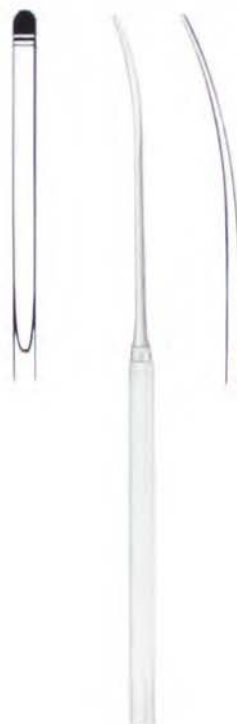

3 mm
 stumpf
 blunt
 romos
 mousse
 smusso

18,5 cm/7" **RU 8850-01**
 21,5 cm/8½" **RU 8850-02**



Crile
 20 cm/8"
 RU 4425-20



Cushing
 19 cm/7½"



RU 4426-01



RU 4426-02



Krayenbühl
 18,5 cm/7½"
 RU 8825-06



RU 8825-07



RU 8825-08



RU 8825-09



Aorta Dilatatore, Aortenstanzen
Aortic Dilators, Aortic Punches
Dilatadores de aorta, Punzonadoras aorticas
Dilatateurs aortiques, Emporte-pièces aortiques
Dilatatori vascolari, Punzonatrice vascolari

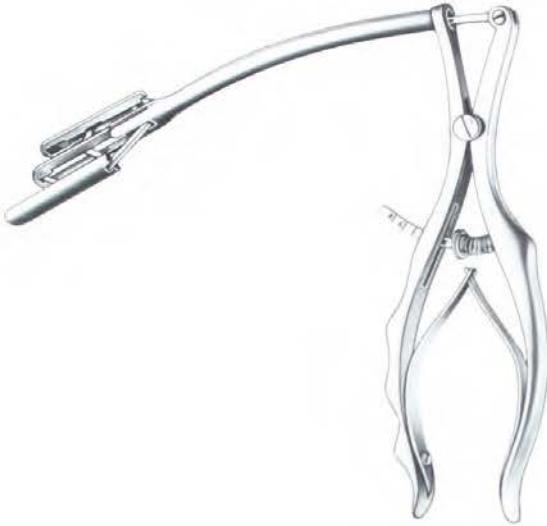

Cooley
RU 7761-00



Tubbs
RU 7763-00

zerlegbar
 detachable
 desmontable
 démontable
 smontabile

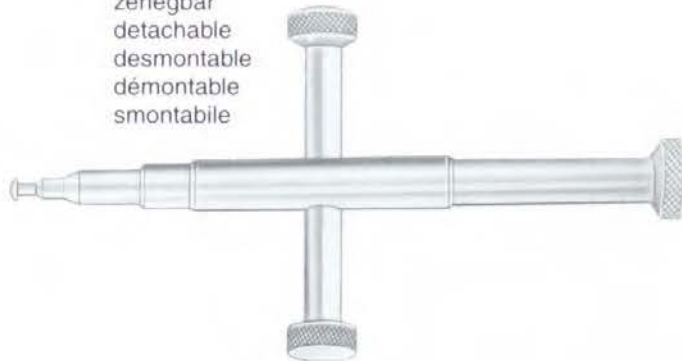

Länge length largo longueur lunghezza	Ø mm	
12 cm/4¾"	3	RU 7765-03
12 cm/4¾"	4	RU 7765-04
12 cm/4¾"	5	RU 7765-05
12 cm/4¾"	6	RU 7765-06
15 cm/6"	3	RU 7765-13
15 cm/6"	4	RU 7765-14
15 cm/6"	5	RU 7765-15
15 cm/6"	6	RU 7765-16

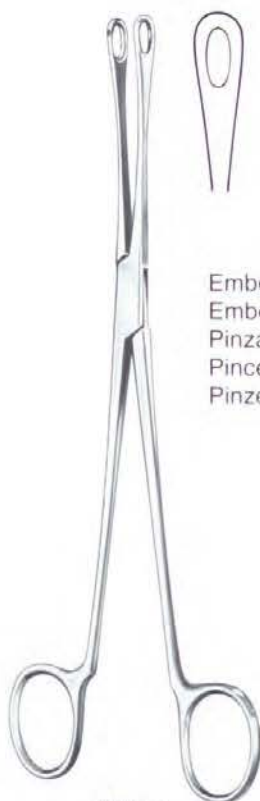

Embolusfaßzange
 Embolus grasping forceps
 Pinzas para coger émbolos
 Pince à saisir le caillot
 Pinze per afferrare ad embolia

Blake
 20 cm/8"
 RU 6650-20



mm Ø	19 cm/7 1/2"	35 cm/14"
0,5	RU 7770-05	RU 7771-05
1,0	RU 7770-10	RU 7771-10
1,5	RU 7770-15	RU 7771-15
2,0	RU 7770-20	RU 7771-20
2,5	RU 7770-25	RU 7771-25
3,0	RU 7770-30	RU 7771-30
3,5	RU 7770-35	RU 7771-35
4,0	RU 7770-40	RU 7771-40
4,5	RU 7770-45	RU 7771-45
5,0	RU 7770-50	RU 7771-50
7,0	RU 7770-70	RU 7771-70
9,0	RU 7770-90	RU 7771-90

De Bakey



Gefäß-Dilatatoren
Vascular Dilators
Dilatadores vasculares
Dilatateurs vasculaires
Dilatatori vascolari

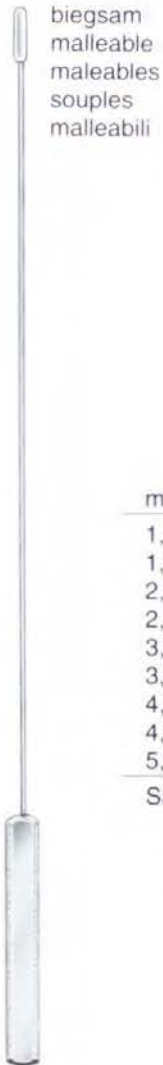

biegsam
malleable
maleables
souples
malleabili

mm Ø	14 cm/5½"	21 cm/8¼"
1,0	RU 7773-00	RU 7773-18
1,5	RU 7773-02	RU 7773-20
2,0	RU 7773-04	RU 7773-22
2,5	RU 7773-06	RU 7773-24
3,0	RU 7773-08	RU 7773-26
3,5	RU 7773-10	RU 7773-28
4,0	RU 7773-12	RU 7773-30
4,5	RU 7773-14	RU 7773-32
5,0	RU 7773-16	RU 7773-34
Satz	RU 7773-36	RU 7773-38

Garrett

Saugkanülen
Aspiration Cannulas
Cánulas de aspiración
Canules d'aspiration
Tubi d'aspirazione



RU 5260-01 ▶

Yankauer
 27 cm/10¹/₂"
 RU 5260-27



Ø 9 mm

mit zentraler Bohrung, Ø 3,0 mm
 und seitlichen Schlitzten
 with central bore, 3.0 mm diam. and
 lateral slots
 con perforación central Ø 3,0 mm
 y hendidura lateral
 avec perçage central Ø 3,0 mm
 et taillades latérales
 con perforazione centrale Ø 3,0 mm
 scanalatura laterale

Olive
 Ø 6 – 10 mm

DeBakey
 27,5 cm/10¹/₂"
 RU 5267-01

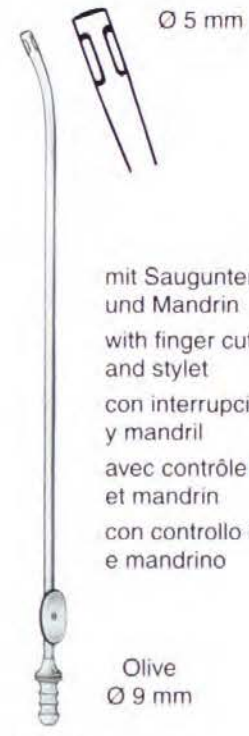

Ø 5 mm

mit Saugunterbrecher
 und Mandrin
 with finger cut-off
 and stylet
 con interrupción de succión
 y mandril
 avec contrôle d'aspiration
 et mandrin
 con controllo di aspirazione
 e mandrino

Olive
 Ø 9 mm

DeBakey
 16 cm/ 6¹/₄" **RU 5268-16**
 27 cm/10³/₄" **RU 5268-27**



mm Ø
 2
 2¹/₃
 2²/₃
 3
 3¹/₃
 3²/₃
 4
 5

Frazier
 Charr./Fr.
 6 **RU 6420-06**
 7 **RU 6420-07**
 8 **RU 6420-08**
 9 **RU 6420-09**
 10 **RU 6420-10**
 11 **RU 6420-11**
 12 **RU 6420-12**
 15 **RU 6420-15**



Ø 4 mm

Fergusson
 Charr./Fr.
 6 **RU 6421-06**
 7 **RU 6421-07**
 8 **RU 6421-08**
 9 **RU 6421-09**
 10 **RU 6421-10**
 11 **RU 6421-11**
 12 **RU 6421-12**

isoliert, mit Saugunterbrecher und Mandrin,
 Griffplatte 90° zur Biegung, LUER-Bohrung
 insulated, with finger cut-off and stylet,
 thumb piece 90° to curve, with LUER hub
 aislada con interrupción de succión
 y mandril, pieza 90° de curvatura, perforación LUER
 isolée, avec contrôle d'aspiration et mandrin,
 touche 90° à la courbure, perçage LUER
 isolato, con controllo di aspirazione, tasto 90° sulla curva,
 con mandrino perforazione LUER

Olive
 Ø 6 – 9 mm
Fergusson
 18 cm/7¹/₂"
RU 6421-34



Saugrohre, Tourniquets
Suction Tubes, Tourniquets
Cánulas de aspiración, Torniquetes
Canules d'aspiration, Tourniquets
Tubi d'aspirazione, Tornichetti



Cooley
25 cm/10"
RU 7780-01



Cooley
33 cm/13"
RU 7780-02



Cooley
30 cm/12"
RU 7780-03



Cooley
30 cm/12"
RU 7780-04



Cooley
35 cm/13³/₄"
RU 7780-05

Tourniquets
Tourniquets
Torniquetes
Tourniquets
Tornichetti



Rumel-Belmont
3,2 mm Ø RU 7787-32
6,4 mm Ø RU 7787-64

Knocheninstrumente
Bone Instruments
Instrumental óseo
Instruments à os
Strumenti ossea

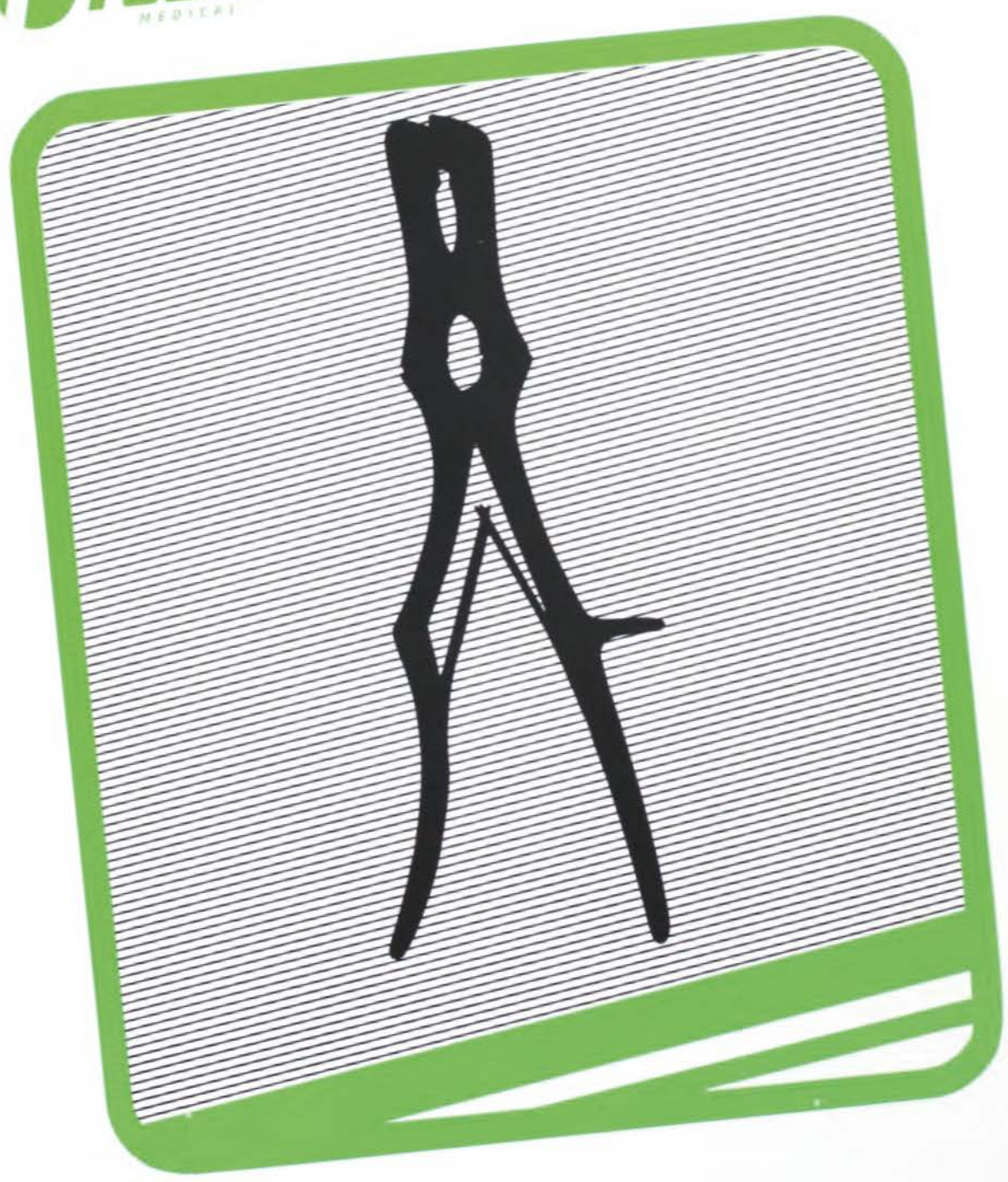



Raspatorien
Periosteal Raspatories
Legras – Periostótomos
Rugines à périostomie
Periostotomi



Langenbeck
19 cm/7½"
RU 5383-19



Langenbeck
18 cm/7"
RU 5384-18



Lambotte
21 cm/8¼"

breit
width
ancho
largeur
larghezza

mm

5	RU 5385-05
10	RU 5385-10
15	RU 5385-15
20	RU 5385-20
25	RU 5385-25



Alexander
20 cm/8"
RU 5387-20



Davidson-Alexander
29 cm/11½"
RU 5389-29



Matson
22 cm/8¾"
RU 5397-22

Raspatorien
Periosteal Raspatories
Legras – Periostótomos
Rugines à périostomie
Periostotomi



Semb

	12 mm	12 mm	12 mm	13 mm	13 mm	15 mm	15 mm
	17,5 cm/7"	21 cm/8¼"	17,5 cm/7"	21 cm/8¼"	22 cm/8¾"	20,5 cm/8"	20,5 cm/8"
	RU 5398-01	RU 5398-02	RU 5398-03	RU 5398-04	RU 5398-05	RU 5398-06	RU 5398-07



Doyen
17 cm/6¾"

	für Erwachsene for adults para adultos pour des adultes per adulti	
	RU 5400-01	RU 5400-02
	für Kinder for children para niños pour des enfants per bambini	
	RU 5402-01	RU 5402-02



Doyen
24 cm/9½"
RU 5401-01 RU 5401-02



Knochenhaltezangen
Bone Holding Forceps
Pinzas para huesos
Daviers porte-os
Tenaglie per ossa



12 mm

Langenbeck
21 cm/8¹/₄"
RU 5514-21



11 mm

Fergusson
21 cm/8¹/₄"
RU 5516-21



8 mm

Semb
19 cm/7¹/₂"
RU 5525-19



7,5 mm

Semb
19 cm/7¹/₂"
RU 5525-51

Hohlmeißelzangen
Bone Rongeur Forceps
Pinzas - gubias
Pinces - gouges
Pinze - sgorbie

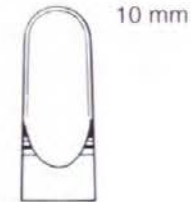

10 mm

gerade
straight
recta
droite
rette
RU 5600-22



10 mm

gebogen
curved
curva
courbe
curve
RU 5601-22

Stille-Luer
22 cm/8³/₄"



RU 5600-27



RU 5601-27

Stille-Luer
27 cm/10¹/₂"



Semb
23 cm/9"
RU 5602-23

Stille-Ruskin
23 cm/9"
RU 5604-23



Hohlmeißelzangen
Bone Rongeur Forceps
Pinzas - gubias
Pinces - gouges
Pinze - sgorbie

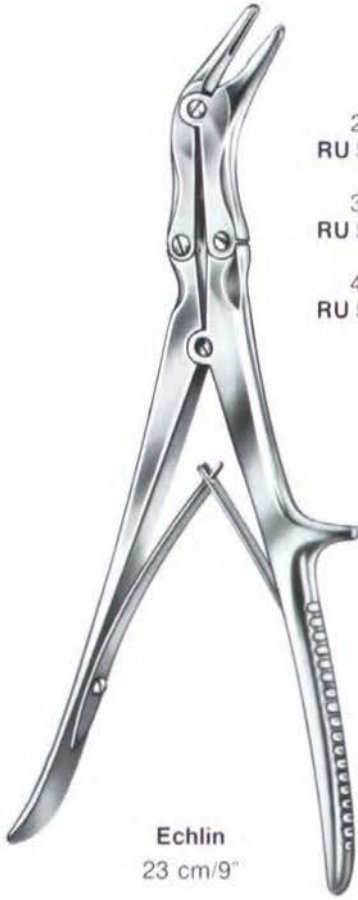

2 mm
 RU 5605-02

3 mm
 RU 5605-03

4 mm
 RU 5605-04

Echlin
 23 cm/9"



3 mm
 RU 5606-03

4 mm
 RU 5606-04

6 mm
 RU 5606-06

8 mm
 RU 5606-08

Leksell
 25 cm/10"



4 mm

Frykholm
 23 cm/9"
 RU 5607-23



6 mm

Stille
 23 cm/9"
 RU 5608-23

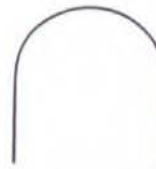

RU 5611-29

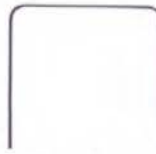

RU 5610-29

Sauerbruch
 30 cm/12"



3 mm

Dale
 34 cm/13½"
 RU 5616-34

Knochensplitterzangen
Bone Cutting Forceps
Pinzas cortantes para huesos
Pinces coupantes à os
Pinze cesoie per ossa



Markwalder
 20 cm/8"
 RU 5635-20



gerade
 straight
 rectas
 droites
 rette
 RU 5640-14
 RU 5640-17
 RU 5640-19
 RU 5640-22



Liston
 gebogen
 curved
 curvas
 courbes
 curve
 cm in
 RU 5641-14
 RU 5641-17
 RU 5641-19
 RU 5641-22



Cleveland
 13 cm/5" RU 5648-13
 15 cm/6" RU 5643-15
 17 cm/6¾" RU 5648-17



Böhler
 15 cm/6"



gerade
 straight
 recta
 droite
 rette
 RU 5700-15



aufgebogen
 curved on flat
 curva
 courbe vers le haut
 curve verso l'alto
 RU 5701-15

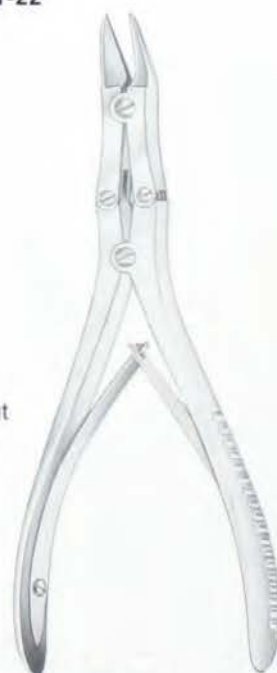

Mc Indoe
 17,5 cm/7"
 RU 5702-17



Knochensplitterzangen
Bone Cutting Forceps
Pinzas cortantes para huesos
Pinces coupantes à os
Pinze cesoie per ossa



gerade
straight
recta
droite
retta
RU 5710-18

aufgebogen
curved on flat
curva sobre el plano
courbe vers le haut
curva verso l'alto
RU 5711-18

Ruskin-Liston
18,5 cm/7¹/₄"

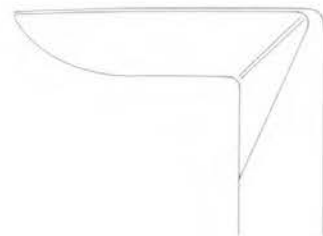

27 cm/10¹/₂"
RU 5715-27

Stille-Liston

23 cm/9"	RU 5716-23	RU 5717-23
27 cm/10 ¹ / ₂ "	RU 5716-27	RU 5717-27



Liston-Key (Horsley)
27 cm/10¹/₂"
RU 5718-27



Semb
24 cm/9¹/₂"
RU 5719-25

Drahtinstrumente
Wire Instruments
Instrumental para alambre
Instruments à fils
Strumenti per fili

 **rudolf**
MEDICAL

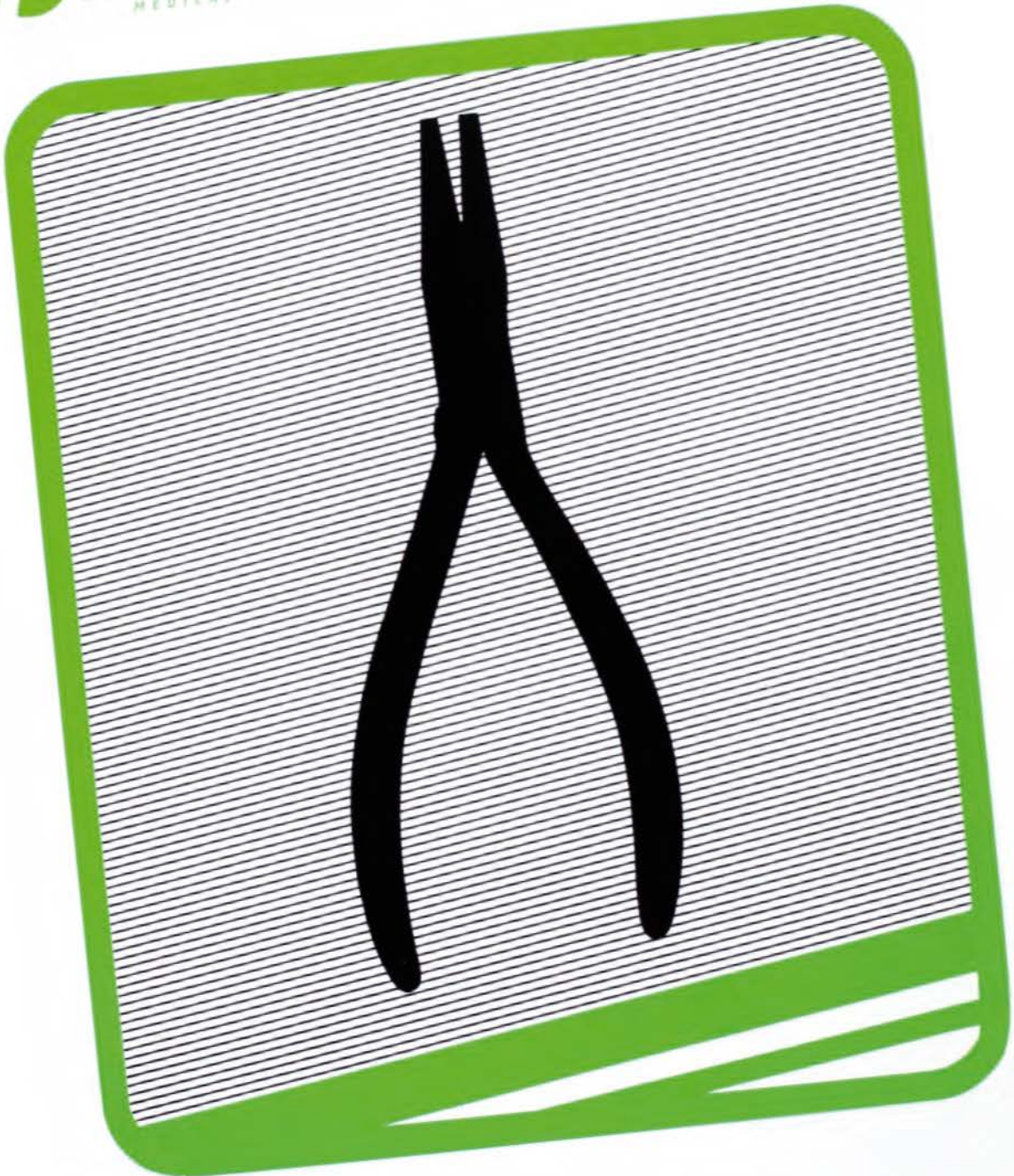



Drahtscheren, Knochendraht, Drahtzangen
Wire Cutting Scissors, Bone Wire, Wire Cutting Pliers
Cizallas para cortar alambre, Hilos para huesos, Alicates para cortar alambre
Coupe-fils, Fil à os, Pinces à fils
Forbici per fili metallici, Filo per ossa, Pinze per fili



Rudolf
TC



gezahnt
saw edge
dentadas
dentelés
dentellate

Universal
12 cm/4¾"
RU 2600-12



Universal
12 cm/4¾"
RU 2601-12



gezahnt
saw edge
dentadas
dentelés
dentellate

Harvey
12,5 cm/5"
RU 2610-12



Knochendraht, in Ringen zu 10 m
 Bone wire, 10 m
 Hilos para huesos, 10 m
 Fil à os, 10 m
 Filo per ossa, 10 m

	weich
	soft
	blando
	mous
	morbidi
mm Ø	
0,2	RU 5778-02
0,3	RU 5778-03
0,4	RU 5778-04
0,5	RU 5778-05
0,6	RU 5778-06
0,7	RU 5778-07
0,8	RU 5778-08
0,9	RU 5778-09
1,0	RU 5778-10
1,2	RU 5778-12
1,5	RU 5778-15



14 cm/5½"
RU 5760-14



0,5 **Rudolf**
TC

RU 5761-00/18 18 cm/7"
 RU 5761-00/20 20 cm/8"

Drahtzangen
 Wire Cutting Pliers
 Alicates para cortar alambre
 Pinces à fils
 Pinze per fili



Rudolf
 TC



Rudolf
 TC

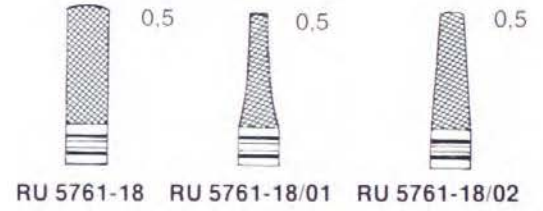

18 cm/7"

Rudolf
 TC

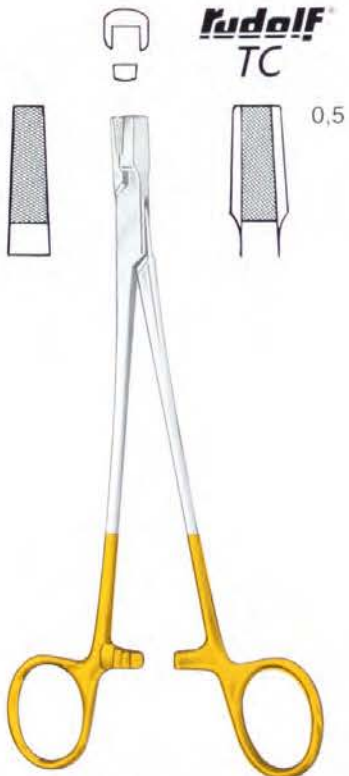

17 cm/6³/₄"
 RU 5761-20/17



17 cm/6³/₄"

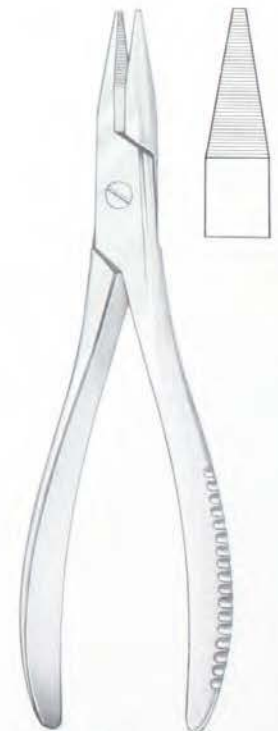

19 cm/7¹/₂"
 RU 5761-30/03



Drahtkneifzangen, Kopf- und Seitenschneider

Wire Cutting Pliers, Lateral and Frontal Cutting Pliers

Alicates para cortar alambre, Alicates para alambre con corte lateral y frontal

Pinces à couper le fil, Pinces coupe-fils coupant latéral et frontal

Tronchese tagliafili, Tenaglie tagliafili, Tronchese taglio laterali



Rudolf
TC

für weichen
Draht bis Ø
for soft wire
with a diam. of max.
para hilos blandos
de un diámetro
maximo de
pour fils mous avec
un diamètre jusqu'à
per fili morbidi
di diametro fino a



12 cm/4³/₄"
RU 5766-12
0,7 mm



18 cm/7"
RU 5767-18
2,0 mm

für harten
Draht bis Ø
for hard wire
with a diam. of max.
para hilos duros
de un diámetro maximo de
pour fils durs avec
un diamètre jusqu'à
per fili duri di
diametro fino a

0,5 mm

1,7 mm

Nadelhalter
Needle Holders
Porta-agujas
Porte-aiguilles
Portaghi

 **rudolf**
MEDICAL





Mikro-Grip Nadelhalter
Micro-Grip Needle Holders
Micro-Grip Porta-agujas
Porte-aiguilles Micro-Grip
Micro-Grip portaghi



Rudolf
MIKRO-GRIP



Castroviejo
 14 cm/5½"

Jacobson
 18 cm/7", 21 cm/8¼"

mit Sperre
 with ratchet
 con cremallera
 avec crémaillère
 con cremagliera



gerade
 straight
 rectas
 droites
 rette



gebogen
 curved
 curvas
 courbes
 curve

14 cm/5½"	RU 5846-02	RU 5846-03
	RU 5846-52	RU 5846-53
18 cm/7"	RU 5846-52 TI	RU 5846-53 TI
	RU 5846-62	RU 5846-63
21 cm/8¼"	RU 5846-62 TI	RU 5846-63 TI

ohne Sperre
 without ratchet
 sin cremallera
 sans crémaillère
 senza cremagliera

14 cm/5½"	RU 5846-04	RU 5846-05
	RU 5846-54	RU 5846-55
18 cm/7"	RU 5846-54 TI	RU 5846-55 TI
	RU 5846-64	RU 5846-65
21 cm/8¼"	RU 5846-64 TI	RU 5846-65 TI

Rudolf
MIKRO-GRIP



Castroviejo
 14 cm/5½"

Jacobson
 18 cm/7" - 23 cm/9"

mit Sperre
 with ratchet
 con cremallera
 avec crémaillère
 con cremagliera



gerade
 straight
 rectas
 droits
 rette



gebogen
 curved
 curvas
 courbes
 curve

14 cm/5½"	RU 5846-14/00	RU 5846-14/01
	RU 5846-18/00	RU 5846-18/01
18 cm/7"	RU 5846-18/00 TI	RU 5846-18/01 TI
	RU 5846-21/00	RU 5846-21/01
21 cm/8¼"	RU 5846-21/00 TI	RU 5846-21/01 TI
	RU 5846-23/00	RU 5846-23/01
23 cm/9"	RU 5846-23/00 TI	RU 5846-23/01 TI

ohne Sperre
 without ratchet
 sin cremallera
 sans crémaillère
 senza cremagliera

14 cm/5½"	RU 5846-14/02	RU 5846-14/03
	RU 5846-18/02	RU 5846-18/03
18 cm/7"	RU 5846-18/02 TI	RU 5846-18/03 TI
	RU 5846-21/02	RU 5846-21/03
21 cm/8¼"	RU 5846-21/02 TI	RU 5846-21/03 TI
	RU 5846-23/02	RU 5846-23/03
23 cm/9"	RU 5846-23/02 TI	RU 5846-23/03 TI

TI = TITAN



Rudolf
 MIKRO-GRIP

Rudolf
 TITAN



15 cm/6"
 17 cm/6¾"
 19 cm/7½"

RU 5847-01 TI
RU 5847-02 TI
RU 5847-03 TI

Ryder

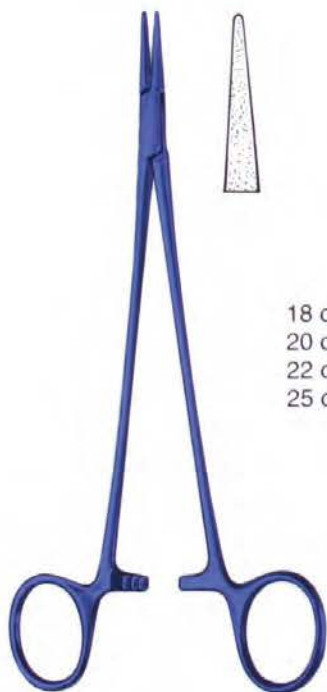

18 cm/7"
 20 cm/8"
 22 cm/8¾"
 25 cm/10"

RU 5847-11 TI
RU 5847-12 TI
RU 5847-13 TI
RU 5847-14 TI

De Bakey



16 cm/6¼"
 18 cm/7"
 20 cm/8"
 22 cm/8¾"
 25 cm/10"

RU 5847-21 TI
RU 5847-22 TI
RU 5847-23 TI
RU 5847-24 TI
RU 5847-25 TI

Microvascular



Mikro-Nadelhalter
Micro Needle Holders
Micro-porta-agujas
Micro-porte-aiguilles
Micro-portaghi



Yasargil

Yasargil

15 cm/6"	RU 5850-15	RU 5851-15			
18 cm/7"	RU 5850-18	RU 5851-18	RU 5852-18	RU 5856-18	RU 5857-18
22,5 cm/8 ³ / ₄ "				RU 5856-23	RU 5857-23



gerade
straight
rectas
droites
rette

mit Sperre
with ratchet
con cremallera
avec crémaillère
con cremagliera



gebogen
curved
curvas
courbes
curve

mit Sperre
with ratchet
con cremallera
avec crémaillère
con cremagliera



abgewinkelt
angled
acodadas
coudées
angolate

mit Sperre
with ratchet
con cremallera
avec crémaillère
con cremagliera

12 cm/4 ³ / ₄ "	RU 5860-12	RU 5864-12	RU 5861-12	RU 5865-12	RU 5863-12	RU 5867-12
15 cm/6"	RU 5860-15	RU 5864-15	RU 5861-15	RU 5865-15		
18,5 cm/7 ¹ / ₄ "	RU 5860-18	RU 5864-18	RU 5861-18	RU 5865-18		
23 cm/9"	RU 5860-23		RU 5861-23			

Mikro-Nadelhalter, Nadelhalter mit Hartmetalleinlagen
Micro Needle Holders, Needle Holders with Tungsten Carbide Inserts
Micro-porta-agujas, Porta-agujas con placas de carburo tungsteno
Micro-porte-aiguilles, Porte-aiguilles avec mors en carbure de tungstène
Micro-portaghi, Portaghi con placche di carburo di tungsteno



gerade
straight
rectas
droites
rette

15 cm/6"
18,5 cm/7¼"
21 cm/8¼"

gebogen
curved
curvas
courbes
curve

15 cm/6"
18,5 cm/7¼"
21 cm/8¼"

Rudolf
TITAN



0,4 mm

RU 5860-15/04 TI
RU 5860-18/04 TI
RU 5860-21/04 TI



0,8 mm

RU 5860-15/08 TI
RU 5860-18/08 TI
RU 5860-21/08 TI



0,4 mm

RU 5861-15/04 TI
RU 5861-18/04 TI
RU 5861-21/04 TI



0,8 mm

RU 5861-15/08 TI
RU 5861-18/08 TI
RU 5861-21/08 TI

Rudolf
TC



Bozemann



0,5

20 cm/8"
RU 6049-20



0,5

24 cm/9½"
RU 6049-24



0,5

26 cm/10½"
RU 6049-26



Mayo-Hegar



0,5

16 cm/6¼"
RU 6050-16
RU 6050-16 TI



0,5

18 cm/7"
RU 6050-18
RU 6050-18 TI



0,5

20 cm/8"
RU 6050-20
RU 6050-20 TI



0,5

24 cm/9½"
RU 6050-24



0,5

26 cm/10½"
RU 6050-26



0,5

30 cm/12"
RU 6050-30



Nadelhalter mit Hartmetalleinlagen
Needle Holders with Tungsten Carbide Inserts
Porta-agujas con placas de carburo tungsteno
Porte-aiguilles avec mors en carbure de tungstène
Portaghi con placche di carburo di tungsteno



Rudolf
TC

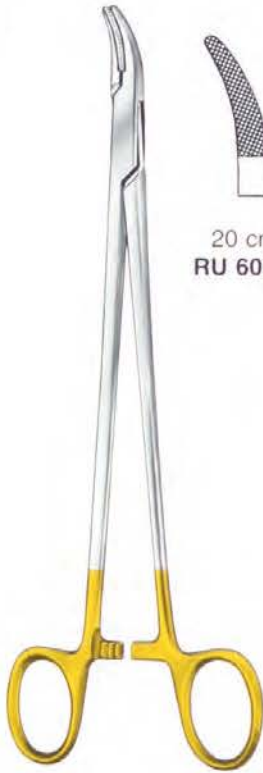

Mayo-Hegar

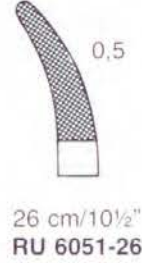

Mayo-Hegar

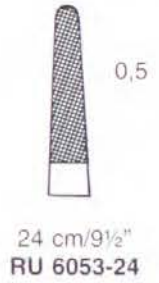
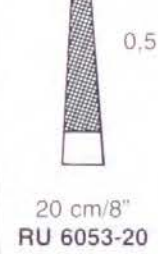

schweres Modell
 heavy pattern
 modelo robusto
 modèle robuste
 modello robusto



De Bakery

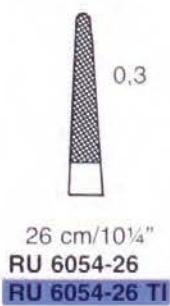
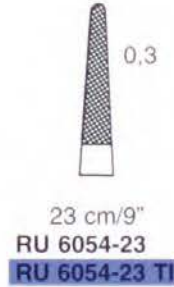
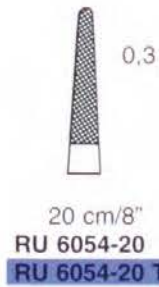
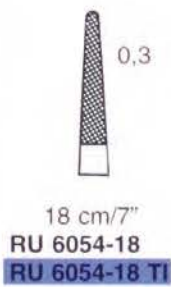

De Bakery-Fine

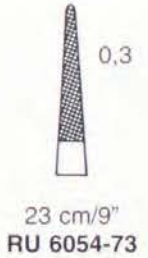
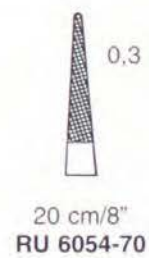

TI = TITAN

Nadelhalter mit Hartmetalleinlagen
 Needle Holders with Tungsten Carbide Inserts
 Porta-agujas con placas de carburo tungsteno
 Porte-aiguilles avec mors en carbure de tungstène
 Portaghi con placche di carburo di tungsteno



Rudolf
 TC

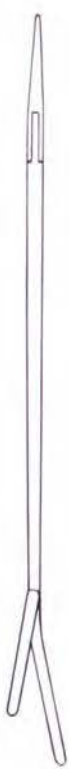

0,4
 19,5 cm/7³/₄"
 RU 6054-89

0,4
 24,5 cm/9³/₄"
 RU 6054-94

De Bakey



0,3
 15 cm/6"
 RU 6055-01

Baby-Crile-Wood



0,4
 15 cm/6"
 RU 6055-15/1

glatt
 smooth
 lisa
 lisse
 liscie
 15 cm/6"
 RU 6055-15/2

Crile-Wood



0,4
 18 cm/7"
 RU 6055-18

0,4
 26 cm/10¹/₄"
 RU 6055-26

Crile-Wood

0,4
 20 cm/8"
 RU 6055-20

0,4
 31 cm/12¹/₄"
 RU 6055-31

0,4
 23 cm/9"
 RU 6055-23

0,4
 13 cm/5"
 RU 6056-13/1
RU 6056-13/1 TI
 glatt
 smooth
 lisa
 lisse
 liscie
 13 cm/5"
 RU 6056-13/2

Halsey



0,2
 12,5 cm/5"
 RU 6057-12

Converse

TI = TITAN



Nadelhalter mit Hartmetalleinlagen
Needle Holders with Tungsten Carbide Inserts
Porta-agujas con placas de carburo tungsteno
Porte-aiguilles avec mors en carbure de tungstène
Portaghi con placche di carburo di tungsteno



Rudolf
TC

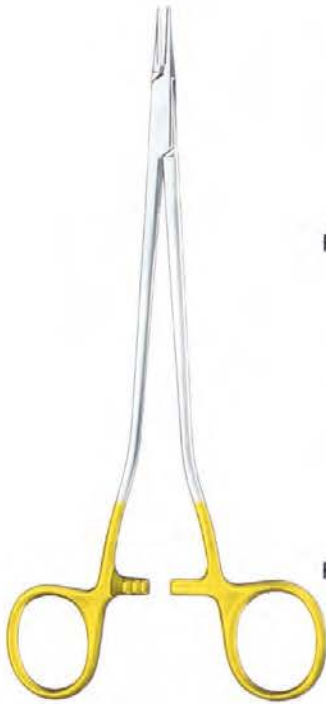

Hegar-Vascular

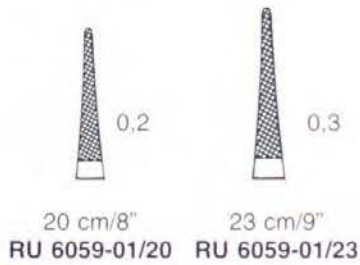
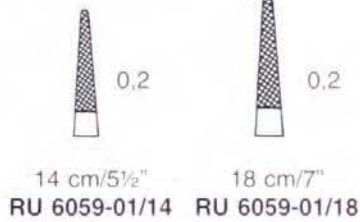

Microvascular

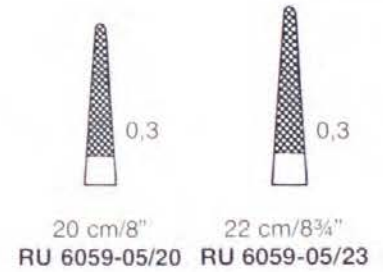
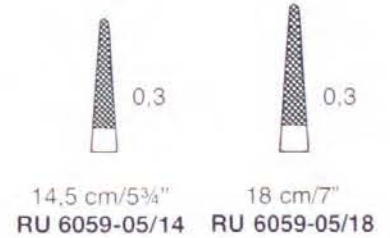

Ryder

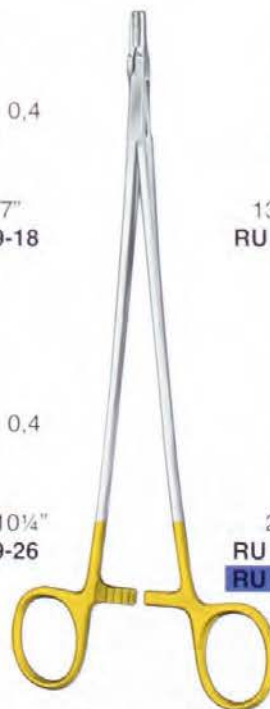
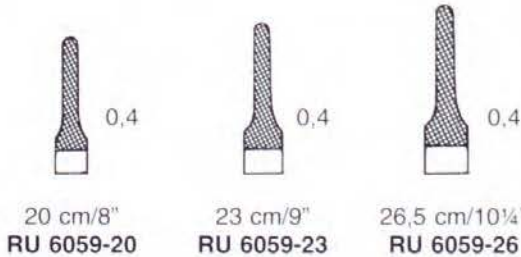

Micro-Ryder

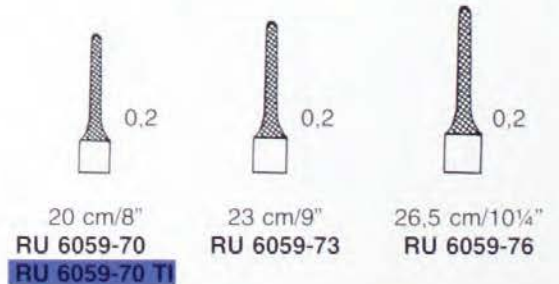
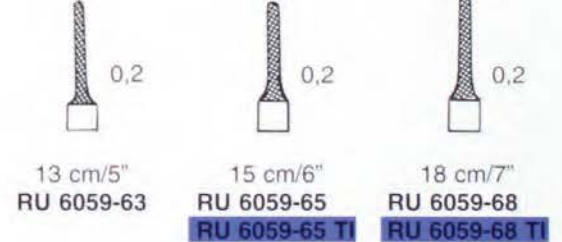

TI = TITAN

Nadelhalter mit Hartmetalleinlagen
 Needle Holders with Tungsten Carbide Inserts
 Porta-agujas con placas de carburo tungsteno
 Porte-aiguilles avec mors en carbure de tungstène
 Portaghi con placche di carburo di tungsteno



Rudolf
TC



Rudolf
(Swedish Pattern)

 0,3
 15 cm/6"
 RU 6060-00/15

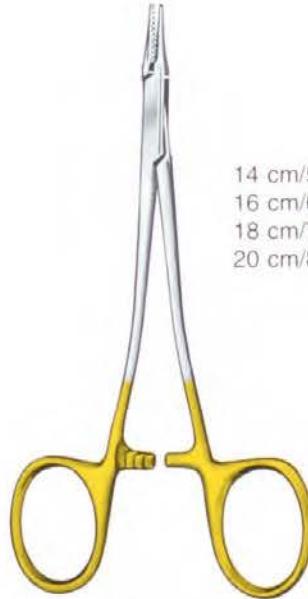

 0,3
 17 cm/6¾"
 RU 6060-00/17

 0,3
 20 cm/8"
 RU 6060-00/20



Eufrate-Pasqué

14 cm/5½"
 16 cm/6¼"
 18 cm/7"
 20 cm/8"

  0,3
 RU 6060-05/14 RU 6060-05/24
 RU 6060-05/16 RU 6060-05/26
 RU 6060-05/18 RU 6060-05/28
 RU 6060-05/20 RU 6060-05/30

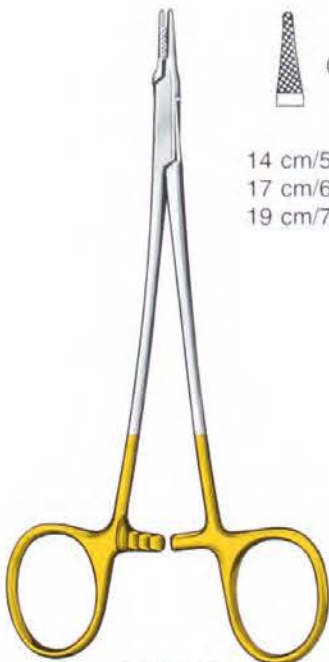

Lemmon

 0,4
 14 cm/5½" RU 6060-07/14
 17 cm/6¾" RU 6060-07/17
 19 cm/7½" RU 6060-07/19



Sarot

 0,4
 18 cm/7" RU 6060-18
 26 cm/10¼" RU 6060-26



Nadelhalter mit Hartmetalleinlagen
Needle Holders with Tungsten Carbide Inserts
Porta-agujas con placas de carburo tungsteno
Porte-aiguilles avec mors en carbure de tungstène
Portaghi con placche di carburo di tungsteno



Rudolf
TC

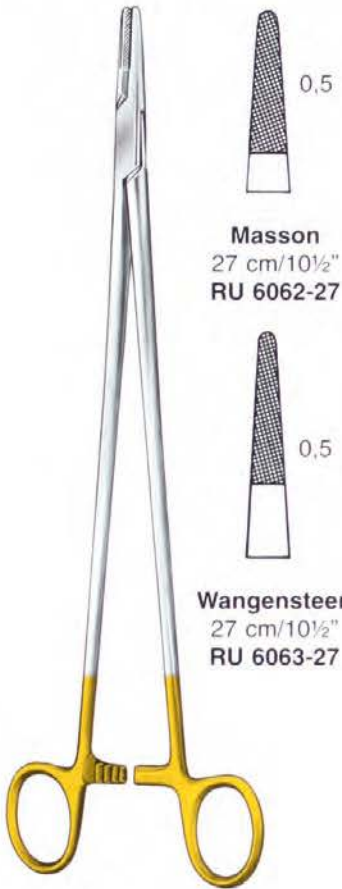

Masson
 27 cm/10½"
 RU 6062-27



Finocchietto

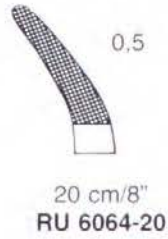

20 cm/8"
 RU 6064-20



27 cm/10½"
 RU 6064-27



Langenbeck-Ryder



20 cm/8"
 RU 6067-18/00



Lichtenberg

20 cm/8"
 RU 6068-20



Tönnis



18 cm/7"
 RU 6069-18



Mathieu-Kocher



14 cm/5½"
 RU 6070-14



20 cm/8"
 RU 6070-20



17 cm/6¾"
 RU 6070-17



Zweifel



20 cm/8" RU 6071-02/20
 23 cm/9" RU 6071-02/23



Nadelhalter mit Hartmetalleinlagen
 Needle Holders with Tungsten Carbide Inserts
 Porta-agujas con placas de carburo tungsteno
 Porte-aiguilles avec mors en carbure de tungstène
 Portaghi con placche di carburo di tungsteno



rudolf
TC



20 cm/8"
RU 6071-20



25 cm/10"
RU 6071-25



14,5 cm/5¾" RU 6082-14
 18,0 cm/7" RU 6082-18
 21,5 cm/8½" RU 6082-22

Castroviejo



14 cm/5½" RU 6082-14/1
 18 cm/7" RU 6082-18/1
 21 cm/8¼" RU 6082-21/1

glatt
smooth
lisas
lisses
liscie



RU 6082-14/2
 RU 6082-18/2
RU 6082-18/2 TI
 RU 6082-21/2
RU 6082-21/2 TI



14 cm/5½" RU 6083-14/1 RU 6083-14/2
 18 cm/7" RU 6083-18/1 RU 6083-18/2
 21 cm/8¼" RU 6083-21/1 RU 6083-21/2

Castroviejo



14 cm/5½"
RU 6084-14/1

glatt
smooth
lisas
lisses
liscie



14 cm/5½"
RU 6084-14/2

Kalt

TI = TITAN



Nadelhalter mit Hartmetalleinlagen
Needle Holders with Tungsten Carbide Inserts
Porta-agujas con placas de carburo tungsteno
Porte-aiguilles avec mors en carbure de tungstène
Portaghi con placche di carburo di tungsteno



Rudolf
TC



Barraquer
 14 cm/5½"
 RU 6085-14



Castroviejo
 13 cm/5"
 RU 6086-13



Hepp-Scheidel

0,3
 18 cm/7"
 RU 6087-18/1
 18 cm/7"
 RU 6087-18/2
 glatt
 smooth
 lisa
 lisse
 liscie



Jacobson



Diethrich

	gerade	gebogen
	straight	curved
	rectas	curvas
	droites	courbes
	rette	curve
16 cm/6¼"	RU 6092-16	RU 6093-16
18 cm/7"	RU 6092-18	RU 6093-18
20 cm/8"	RU 6092-20	RU 6093-20
23 cm/9"	RU 6092-23	RU 6093-23
25 cm/10"	RU 6092-25	RU 6093-25

Gewebe- und Organfaßzangen
Tissue and Organ Grasping Forceps
Pinzas para coger tejidos y órganos
Pinces à tissue et à saisir les organes
Pinze per afferrare tessuti ed organi

 **rudolf**
MEDICAL

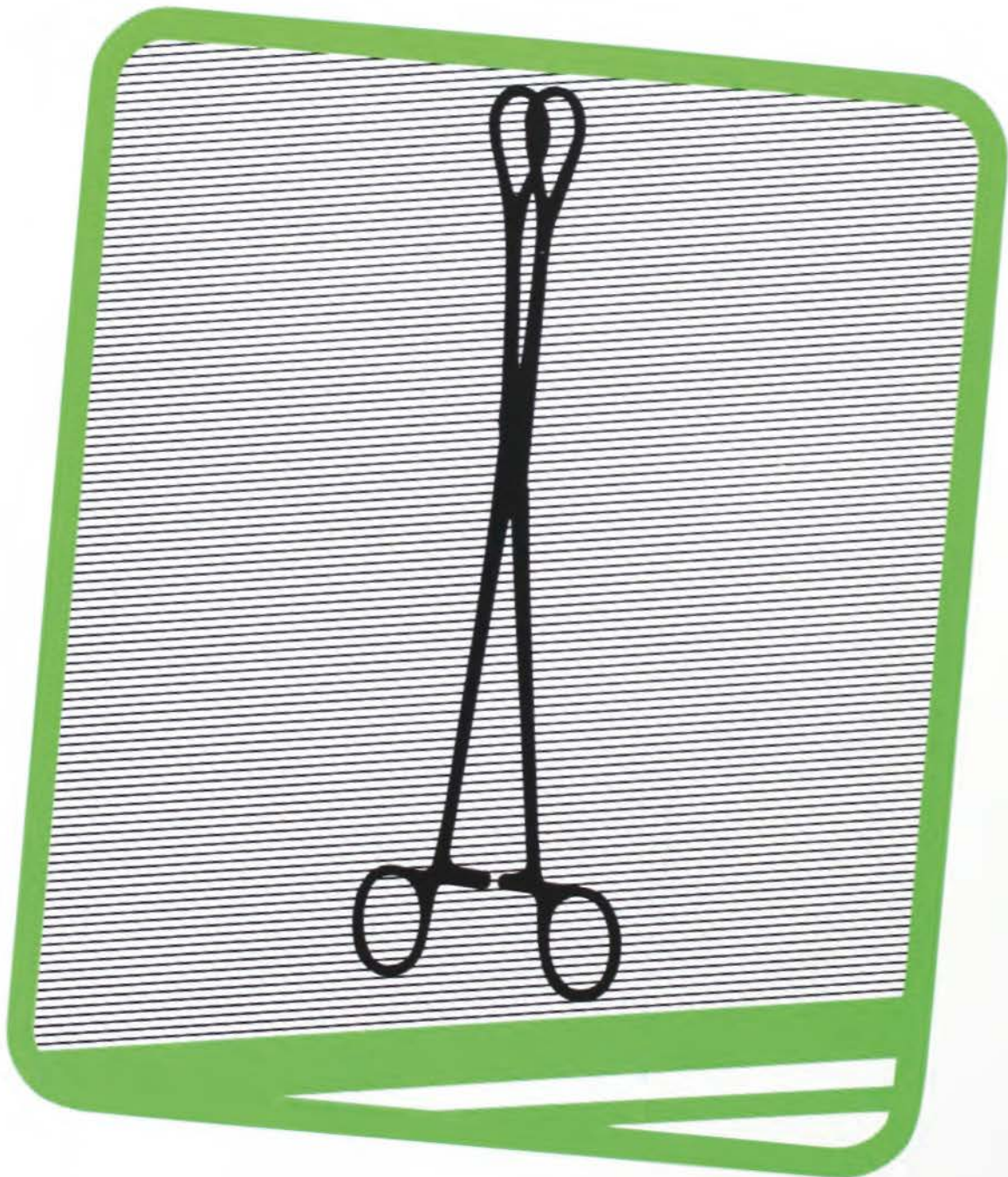



Gewebe- und Organfaßzangen
 Tissue and Organ Grasping Forceps
 Pinzas para coger tejidos y órganos
 Pinces à tissue et à saisir les organes
 Pinze per afferrare tessuti ed organi



Allis-Atrauma

16 cm/6¹/₄" RU 6505-16
 20 cm/8" RU 6505-20
 25 cm/10" RU 6505-25
 30 cm/12" RU 6505-30



Williams

16 cm/6¹/₄"
 RU 6514-16



Babcock-Atrauma



Babcock (Standard)

cm/in		
16 cm/6 ¹ / ₄ "	RU 6517-16	RU 6518-16
18 cm/7"		RU 6518-18
20 cm/8"	RU 6517-20	RU 6518-20
24 cm/9 ¹ / ₂ "		RU 6518-24

Gewebe- und Organfaßzangen
 Tissue and Organ Grasping Forceps
 Pinzas para coger tejidos y órganos
 Pinces à tissu et à saisir les organes
 Pinze per afferrare tessuti ed organi



	cm	in	
RU 6520-18	18	7	
RU 6520-20	20	8	RU 6522-20
	23	9	RU 6522-23





Rippenscheren, Sternumscheren
Rib Shears, Sternum Scissors
Costótomos, Tijeras de esternón
Costotomes, Ciseaux à sternum
Costotomi, Forbici per sterno

 **rudolf**
MEDICAL





Rippenscheren, Sternumscheren
Rib Shears, Sternum Scissors
Costótomos, Tijeras de esternón
Costotomes, Ciseaux à sternum
Costotomi, Forbici per sterno



Collin
22 cm/8³/₄"
RU 2805-22



Gluck
22 cm/8³/₄"
RU 2820-22



Stille
21 cm/8¹/₄"
RU 2825-21



Sauerbruch
24 cm/9¹/₂" RU 7500-24
26 cm/10¹/₄" RU 7500-26



Giertz-Stille
27 cm/10¹/₂"
RU 7501-27



Bethune
34 cm / 13 1/2"
RU 7504-34



Brunner
32 cm / 12 1/2"

RU 7505-32
für die rechte Hand
for the right hand
para la mano derecha
pour la main droite
per la mano destra

RU 7506-32
für die linke Hand
for the left hand
para la mano izquierda
pour la main gauche
per la mano sinistra



Lebsche
24,5 cm / 9 3/4"
RU 7507-24



Rippensperrer
Rib Spreaders
Separadores costales
Ecarteurs costaux
Divaricatori costali

 **rudolf**
MEDICAL





Rippensperrer
Rib Spreaders
Separadores costales
Ecarteurs costaux
Divaricatori costali

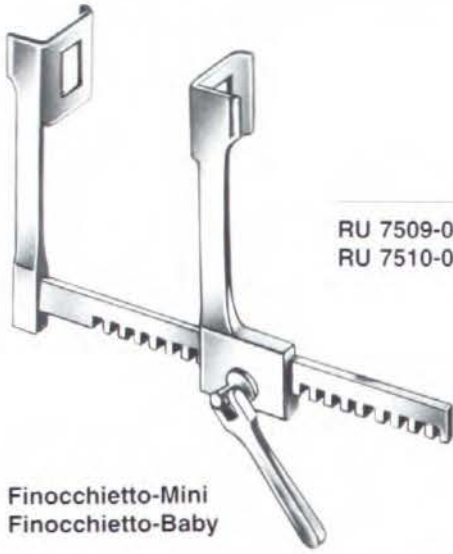

Finocchietto-Mini
Finocchietto-Baby

	a	b	c
RU 7509-00	6 mm	7 mm	36 mm
RU 7510-00	18 mm	20 mm	80 mm

Abmessungs-Schema
 scheme of dimensions
 esquema de dimensiones
 schéma des dimensions
 schema per le dimensioni

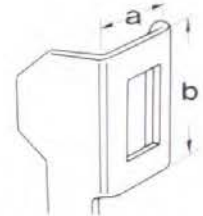

Größe der Valve
 size of blades
 tamaño de la valva
 dimensions des valves
 dimensioni delle valve

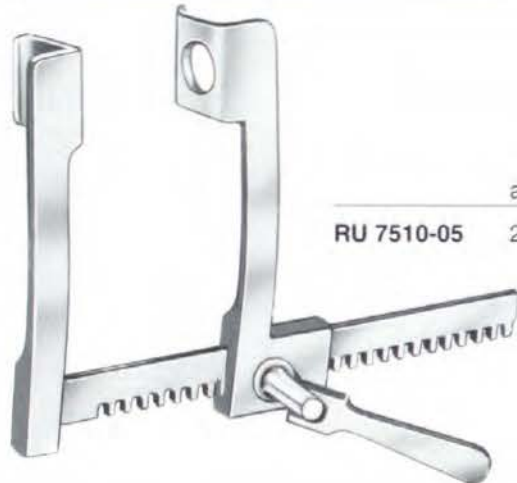

	a	b	c
RU 7510-05	28 mm	32 mm	120 mm

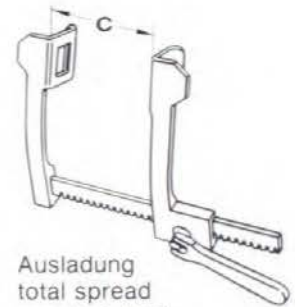

Ausladung
 total spread
 apertura total
 ouverture totale
 apertura totale

◀ 70 mm ▶



Struck
RU 7511-00

bestehend aus:
 consisting of:
 compuesto de:
 consistant en:
 composto da:
 RU 7511-10, RU 7511-18, RU 7511-19

RU 7511-10
 Sperrer, allein
 Spreader, only
 Separador, suelto
 Ecarteur, seul
 Divaricatori, solo

für Kleinkinder
 for children
 para niños
 pour des enfants
 per bambini



10 x 10 mm
RU 7511-15



10 x 15 mm
RU 7511-16



10 x 20 mm
RU 7511-17



15 x 20 mm
RU 7511-18



20 x 20 mm
RU 7511-19



Finocchietto

	a	b	c
RU 7512-01	36 mm	45 mm	140 mm
RU 7512-03	44 mm	65 mm	200 mm
RU 7512-04	44 mm	65 mm	250 mm
RU 7512-05	44 mm	65 mm	300 mm
RU 7512-06	65 mm	65 mm	200 mm
RU 7512-07	65 mm	65 mm	250 mm
RU 7512-08	65 mm	65 mm	300 mm

mit 2 Paar auswechselbaren Valven
 with 2 pairs of interchangeable blades
 con 2 pares de valvas intercambiables
 avec 2 paires de valves interchangeables
 con 2 paia di valve

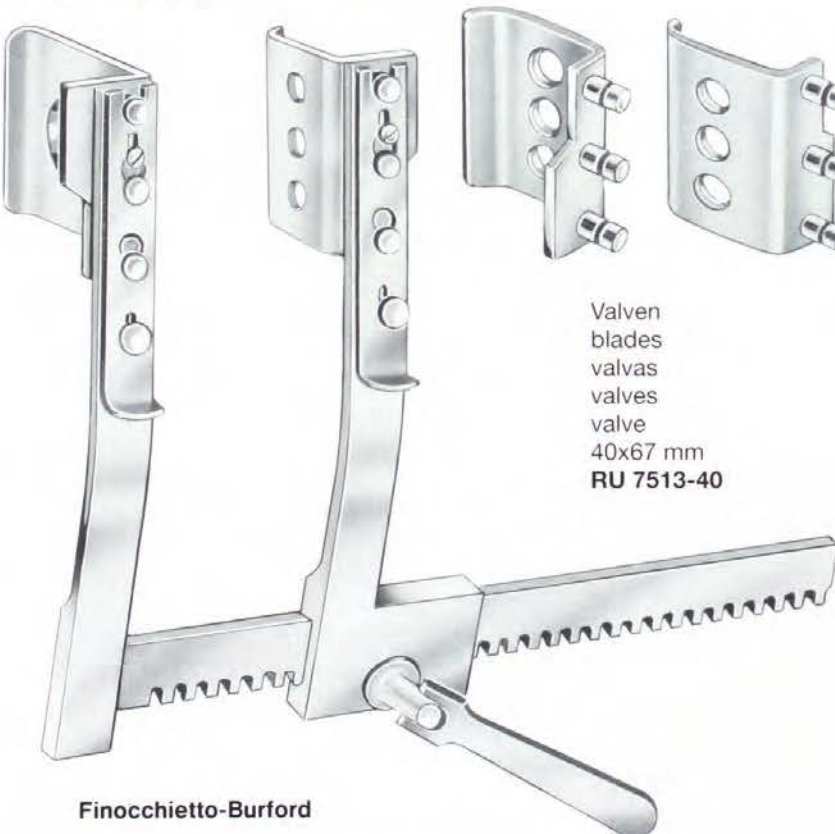

Finocchietto-Burford

Valven
 blades
 valvas
 valves
 valve
 40x67 mm
RU 7513-40

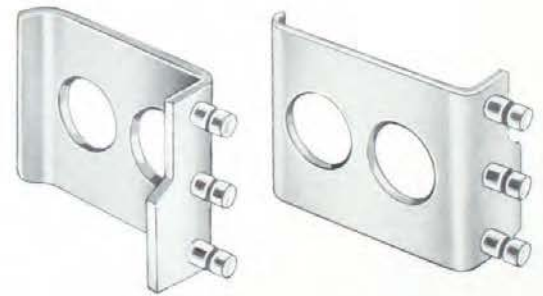

Valven
 blades
 valvas
 valves
 valve
 80x67 mm
RU 7513-41

Spreizweite
 total spread
 apertura total
 ouverture totale
 apertura totale

200 mm/8" **RU 7513-01**
 250 mm/10" **RU 7513-02**
 305 mm/12" **RU 7513-03**



Rippensperrer
 Rib Spreaders
 Separadores costales
 Ecarteurs costaux
 Divaricatori costali

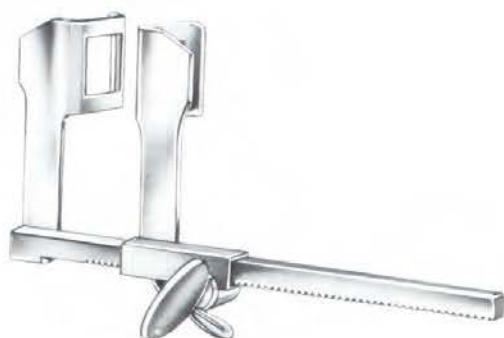

Haight

	a	b	c
RU 7516-00	30 mm	30 mm	115 mm



Rienhoff-Finocchietto

	a	b	c
RU 7516-05	20 mm	25 mm	150 mm



Cooley
 (Cooley-Baby)

	a	b	c
RU 7518-01	15 mm	30 mm	100 mm
RU 7518-02	21 mm	45 mm	145 mm
RU 7518-03	32 mm	50 mm	190 mm



De Bakey
RU 7520-00
 mit 3 Paar Blättern
 with 3 pairs of blades
 con 3 pares de valvas
 avec 3 paires de valves
 con 3 paia di valve
 (RU 7520-21, RU 7520-22, RU 7520-23)

RU 7520-10
 Sperrer, allein
 Spreader, only
 Separador, suelto
 Ecarteur, seul
 Divaricatore, solc



De Bakey
RU 7521-00
 mit 3 Paar Blättern
 with 3 pairs of blades
 con 3 pares de valvas
 avec 3 paires de valves
 con 3 paia di valve

RU 7521-10
 Sperrer, allein
 Spreader, only
 Separador, suelto
 Ecarteur, seul
 Divaricatore, solo





Rippensperrer
 Rib Spreaders
 Separadores costales
 Ecarteurs costaux
 Divaricatori costali



	a	b	c
RU 7522-01	12 mm	20 mm	155 mm
RU 7522-02	40 mm	20 mm	155 mm

Morse-Favaloro

Thoraxsperrer
 Thoracic retractor
 Separador torácico
 Ecarteur thoracique
 Divaricatore per il torace

75x85 mm
 RU 7523-21

48x65mm
 RU 7523-22



RU 7523-10
 Sperrer, allein
 Retractor, only
 Separador, suelto
 Ecarteur, seul
 Divaricatore, solo

(Mercedes-Retractor)

RU 7523-00
 komplett
 complete
 completo
 complet
 completo

Rippensperrer aus Leichtmetall
 Rib Spreaders Made of Aluminium
 Separadores costales de aluminio
 Ecarteurs costaux en aluminium
 Divaricatori costali in alluminio



Rudolf
 ALU

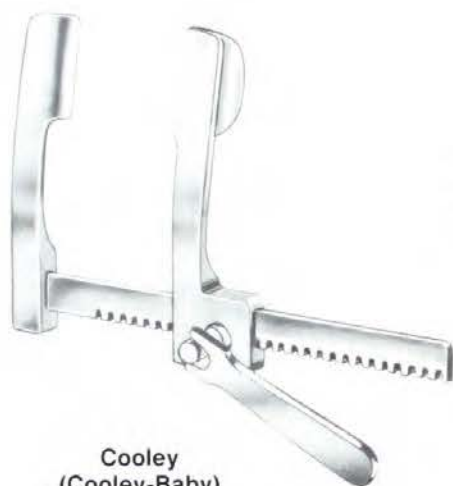

Cooley
 (Cooley-Baby)

	a	b	c
RU 7524-01	15 mm	15 mm	70 mm
RU 7524-02	15 mm	30 mm	100 mm
RU 7524-04	30 mm	50 mm	185 mm

Rudolf
 ALU



Cooley

für Kleinkinder, mit konkaven Valven
 for children with, concave blades
 para niños, con valvas concavas
 pour des enfants, avec valves concaves
 per bambini, con valve concavi

	a	b	c
RU 7524-11	11 mm	15 mm	90 mm

Rudolf
 ALU



Finocchietto modif.

	a	b	c
RU 7524-21	10 mm	15 mm	120 mm



Rippensperrer aus Leichtmetall
Rib Spreaders Made of Aluminium
Separadores costales de aluminio
Ecarteurs costaux en aluminium
Divaricatori costali in alluminio



Rudolf
ALU



Castaneda

	a	b	c
RU 7525-01	12 mm	32 mm	70 mm
RU 7525-02	15 mm	45 mm	75 mm
RU 7525-03	15 mm	60 mm	100 mm

Rudolf
ALU



Morse-Favaloro

	a	b	c
RU 7526-01	20 mm	20 mm	155 mm
RU 7526-02	40 mm	20 mm	155 mm

Rudolf
ALU



Morse

	a	b	c
RU 7526-11	20 mm	20 mm	165 mm
RU 7526-12	20 mm	30 mm	210 mm



rudolf
ALU



	a	b	c
RU 7527-01	12 mm	15 mm	70 mm
RU 7527-02	27 mm	30 mm	95 mm

Finocchietto-Baby-Haight

rudolf
ALU



	a	b	c
RU 7527-11	30 mm	45 mm	140 mm
RU 7527-12	40 mm	65 mm	175 mm
RU 7527-13	75 mm	65 mm	175 mm

Finocchietto

rudolf
ALU



	a	b	c
für Kinder / for children / para niños pour enfants / per bambini			
RU 7528-00	48 mm 34 mm	42 mm 42 mm	135 mm 135 mm
RU 7528-01	67 mm 48 mm	62 mm 62 mm	180 mm
RU 7528-02	67 mm 48 mm	62 mm 62 mm	260 mm
RU 7528-03	67 mm 48 mm	62 mm 62 mm	300 mm

Burford
 mit 2 Paar Valven
 with 2 pairs of blades
 con 2 pares de valvas
 avec 2 paires de valves
 con 2 paia di valve



Rippensperrer, Rippenkontraktoren
 Rib Spreaders, Rib Contractors
 Separadores costales, Aproximadores costales
 Ecarteurs costaux, Rapprocheurs costaux
 Divaricatori costali, Approssimatori costali



Rudolf
 TITAN



Neonatal Sternumsperrer mit 2 Paar auswechselbaren Valven
 Neonatal sternum spreader with 2 pairs of interchangeable blades
 Separador de esternón para recién nacidos con 2 pares de valvas intercambiables
 Ecarteur à sternum pour des nouveaux-nés avec 2 paires de valves interchangeables
 Divaricatori per sterno per neonati con 2 paia di valve

RU 7530-00TI



Sellors
 19 cm / 7 1/2"
 RU 7533-19



Bailey-Baby
 14 cm / 5 1/2"
 RU 7534-14



Bailey
 18,5 cm / 7 1/4"
 RU 7536-16



Bailey-Gibbon
 16 cm / 6 1/4"
 RU 7537-16

TI = TITAN

Gefäßklemmen, Atrauma Klemmen
Vessel Clamps, Atraumatic Clamps
Clamps vasculares, Clamps atraumaticos
Clamps vasculaires, Clamps atraumatiques
Pinze vascolari atraumatiche

 **rudolf**
MEDICAL



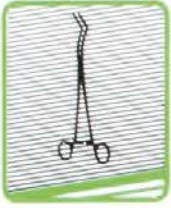

Bronchusklemmen, Gefäßklemmen
Bronchus Clamps, Blood Vessel Clamps
Pinzas-clamps para bronquios y vasos
Pinces-clamps à bronches, Pinces vasculaires
Pinze per bronchi, Pinze cardiovascolari



Bronchusklemmen
 Bronchus clamps
 Pinzas-clamps para bronquios
 Pinces-clamps à bronches
 Pinze per bronchi

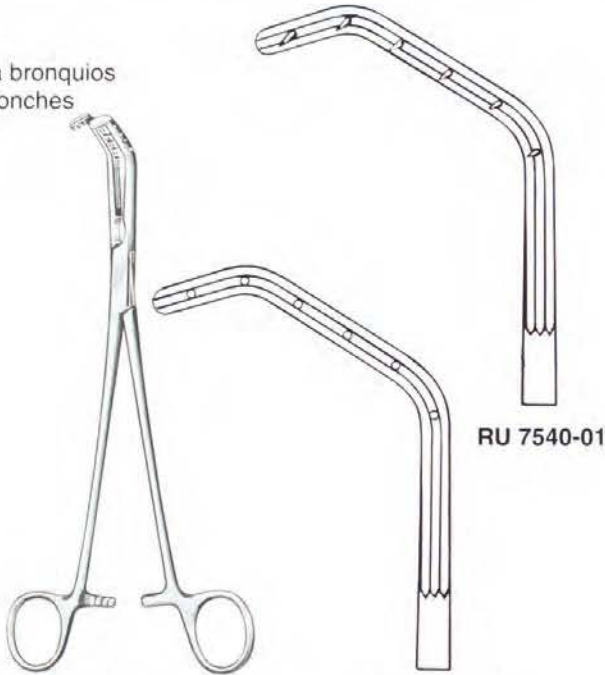

Price-Thomas
 22 cm/8³/₄"

RU 7540-02



Price-Thomas
 22 cm/8³/₄"
RU 7540-22



RU 7549-24 **RU 7548-24**

Semb
 24 cm/9¹/₂"

Lungenfaßzangen
 Lung grasping forceps
 Pinzas-clamps pulmonares
 Pinces-clamps à poumons
 Pinze per polmone



Lovelace
 20 cm/8"
RU 7560-20

Lovelace
 20 cm/8"
RU 7561-20

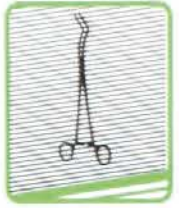

Fig. 1
 Fig. 2

Satinsky
 26,5 cm/10 1/2"
 RU 7566-01 Fig. 1
 RU 7566-02 Fig. 2

RU 7567-01
 RU 7567-02



Baby-Satinsky
 15 cm/6"
 RU 7568-15

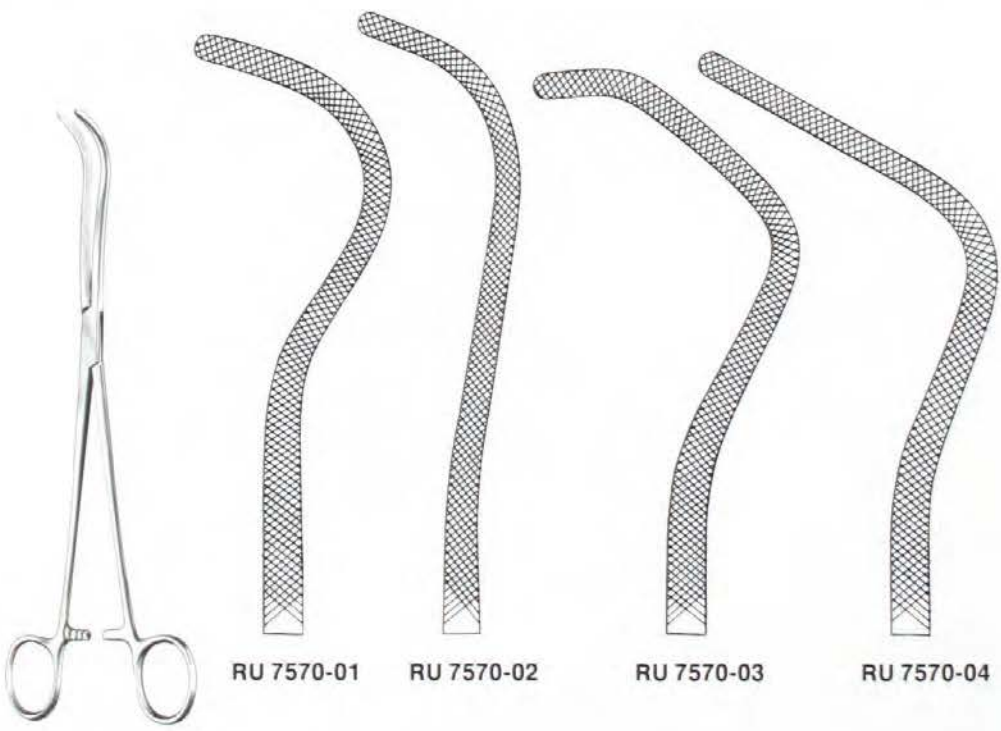

Harken
 24 cm/9 1/2"

RU 7570-01 RU 7570-02 RU 7570-03 RU 7570-04



Atrauma Cardiovascular-Klemmen
Atrauma Cardiovascular Forceps
Atrauma Pinzas-clamps cardiovasculares
Pinces vasculaires atraumatiques
Pinze cardiovascolari atraumatiche



Zahnung nach De Bakey:

Die ATRAUMA-Klemmen mit Tradition. Neben Herz- und Gefäß-Chirurgie auch für andere atraumatische Anwendungsbereiche und Operationstechniken bewährt. Unverrückbares, exaktes Fassen des Gewebes, sicheres und fein dosierbares Abklemmen der Gefäße.

Toothing according to De Bakey:

The traditional ATRAUMA clamps. Apart from cardiovascular surgery, they are also approved for other atraumatic application and surgery techniques. Firm and precise seizing of tissues, safe and delicately controlled clamping effect.

Dentado según De Bakey:

Pinzas ATRAUMA tradicionales. Probadas no sólo en la cirugía cardiovascular, sino también en otros sectores de aplicaciones y técnicas de operación. Clampaje firme y exacto del tejido, «clamping» seguro de los vasos.

Denture d'après De Bakey:

Le clamp ATRAUMA traditionnel. Eprouvé dans la chirurgie du thorax et vasculaire de même que dans d'autres domaines et pour d'autres techniques opératoires non-traumatisantes. Préhension parfaite et exacte du tissu, clampage sûr des vaisseaux.

Dentatura secondo De Bakey:

Le pinze ATRAUMA a lunga tradizione. Eccellenti risultati sia nella chirurgia cardiaca e vascolare che anche in altri campi di applicazione e di tecniche operative atraumatiche. Presa fissa ed esatta dei vasi.

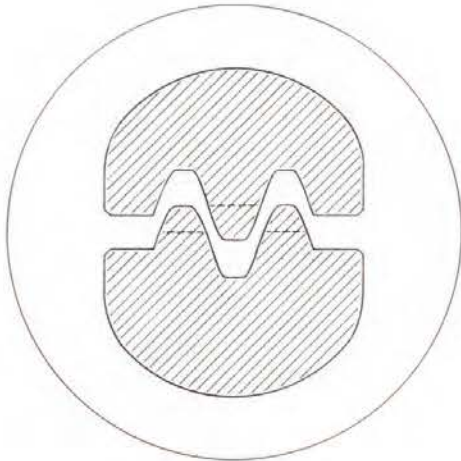

Zahnung nach Cooley:

Durch die sehr schmalen Maulteile einsetzbar in extrem begrenztem Operationsfeld. Besonders bei Säuglings- und Herzchirurgie. Fester Griff ohne Quetschungen.

Toothing according to Cooley:

Very narrow jaws for application in extremely limited operational field. Particularly approved for cardiovascular surgery and pediatry. Firm grip without squeezing.

Dentado según Cooley:

Debido a la boca muy estrecha se puede aplicar en campos operatorios extremadamente pequeños. Especialmente para cirugía infantil y del corazón. Clampaje fuerte sin contusiones.

Denture d'après Cooley:

Les mors très étroits permettent d'intervenir dans des parties extrêmement limitées du champ opératoire. En particulier pour la chirurgie cardiovasculaire et infantile. Prise sûre sans écrasement.

Dentatura secondo Cooley:

I becchi sottilissimi permettono l'uso in campi operativi estremamente limitati, soprattutto nella chirurgia cardiaca e infantile. Presa sicura senza contusioni.

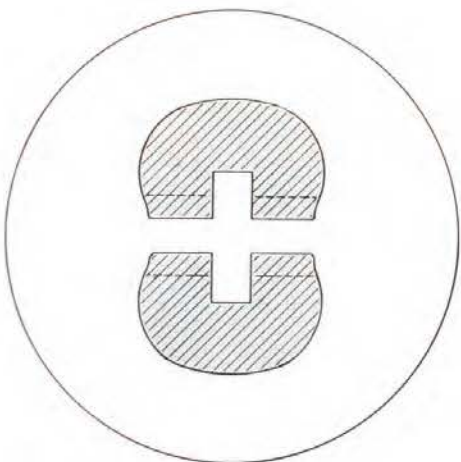

Atrauma-Pinzetten
Atrauma Forceps
Pinzas de disección atrauma
Pinces atraumatiques
Pinze cardiovascolari atraumatiche



Rudolf
TC



De Bakey

Rudolf
DE BAKEY



De Bakey



De Bakey-Gerald

Maulbreite
width of jaw
ancho de boca
largeur du mors
larghezza

del morso	1,5 mm	2,0 mm	2,7 mm	3,5 mm	1,2 mm	2,0 mm	1,2 mm
15 cm/6"	RU 7571-15/15	RU 7571-20/15	RU 7571-27/15	RU 7571-35/15	RU 7575-12/18	RU 7575-20/18	RU 7576-15
18 cm/7"					RU 7575-12/18 TI	RU 7575-20/18 TI	RU 7576-18
19,5 cm/7½"	RU 7571-15/19	RU 7571-20/19	RU 7571-27/19	RU 7571-35/19			
21 cm/8¼"					RU 7575-12/21	RU 7575-20/21	
24 cm/9½"	RU 7571-15/24	RU 7571-20/24	RU 7571-27/24	RU 7571-35/24			



1,5 mm

15 cm/6"
RU 7576-25

19,5 cm/7¾"
RU 7576-29

24 cm/9½"
RU 7576-34

De Bakey-Diethrich



2,0 mm

18 cm/7"
RU 7577-18

20 cm/8"
RU 7577-20

De Bakey Bayonet



2,0 mm

15 cm/6"
RU 7579-15

19,5 cm/7½"
RU 7579-19

Cooley



12 cm/4¾"
RU 7585-12

15 cm/6"
RU 7585-15

Adson

TI = TITAN



Atrauma-Pinzetten
Atrauma Forceps
Pinzas de disección atrauma
Pinces atraumatiques
Pinze cardiovascolari atraumatiche



Rudolf
TITAN

Rudolf
DE BAKEY

Maulbreite
width of jaw
ancho de boca
largeur du mors
larghezza
del morso

	1,0 mm	1,5 mm	1,8 mm	2,0 mm	2,8 mm
15 cm/6"	RU 7580-10/15 TI	RU 7580-15/15 TI	RU 7580-18/15 TI	RU 7580-20/15 TI	RU 7580-28/15 TI
19,5 cm/7¾"	RU 7580-10/19 TI	RU 7580-15/19 TI	RU 7580-18/19 TI	RU 7580-20/19 TI	RU 7580-28/19 TI
24 cm/9½"	RU 7580-10/24 TI	RU 7580-15/24 TI	RU 7580-18/24 TI	RU 7580-20/24 TI	RU 7580-28/24 TI

De Bakey



Maulbreite
width of jaw
ancho de boca
largeur du mors
larghezza
del morso

	1,5 mm	2,0 mm	2,7 mm	3,5 mm
16 cm/6¼"	RU 7580-16	RU 7581-16	RU 7582-16	RU 7583-16
20 cm/8"	RU 7580-20	RU 7581-20	RU 7582-20	RU 7583-20
24 cm/9½"	RU 7580-24	RU 7581-24	RU 7582-24	RU 7583-24
30 cm/12"	RU 7580-30	RU 7581-30	RU 7582-30	RU 7583-30

De Bakey



Maulbreite
width of jaw
ancho de boca
largeur du mors
larghezza
del morso

	2,0 mm
	RU 7584-16
	RU 7584-20
	RU 7584-24
	RU 7584-30

De Bakey

TI = TITAN



rudolf
 DE BAKEY

Anlegezange
 Setting forceps
 Pinzas para poner clips
 Pince pour poser les clips
 Pinza per applicare clips



23 cm/9"
 RU 7586-00



RU 7586-07
 RU 7586-07 TI

8 cm/3"



RU 7587-07
 RU 7587-07 TI

RU 7586-08
 RU 7586-08 TI

9 cm/3 1/2"

RU 7587-08
 RU 7587-08 TI

RU 7586-10
 RU 7586-10 TI

10,5 cm/4"

RU 7587-10
 RU 7587-10 TI

RU 7586-12
 RU 7586-12 TI

13 cm/5"

RU 7587-12
 RU 7587-12 TI



De Bakey-Diethrich

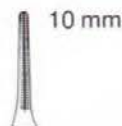

10 mm

RU 3934-60



14 mm

RU 3934-64



20 mm

RU 3934-70

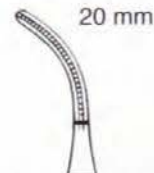

20 mm

RU 3934-71



10 mm

RU 3935-60



14 mm

RU 3935-64



20 mm

RU 3935-70



Atrauma Bulldogklemmen
 Atrauma Bulldog Clamps
 Clamps Bulldog atraumaticos
 Clamps atraumatiques Bulldog
 Pinze atraumatiche Bulldog



Rudolf
 DE BAKEY



De Bakey
 5,0 cm/2"
 RU 7586-10/50



De Bakey
 4,5 cm/1¾"
 RU 7586-11/50



Glover
 RU 7588-06 5 cm/2"
 RU 7588-07 7 cm/2¾"
 RU 7588-09 8,5 cm/3½"
 RU 7588-11 13 cm/5"



Glover
 RU 7589-06 4 cm/1½"
 RU 7589-07 6,5 cm/2½"
 RU 7589-09 8 cm/3"
 RU 7589-11 12 cm/4¾"



Glover
 5 cm/2"
 RU 7590-05



De Bakey-Satinsky
 6 cm/2½"
 RU 7590-07



Atrauma Bulldogklemmen
 Atrauma Bulldog Clamps
 Clamps Bulldog atraumaticos
 Clamps atraumatiques Bulldog
 Pinze atraumatiche Bulldog



De Bakey
 8 cm/3 1/4"
 RU 7590-09



De Bakey
 10,5 cm/4 1/4"
 RU 7590-10



Santulli
 7 cm/2 3/4"
 RU 7591-07
RU 7591-07 TI



Gregory-Soft

9 cm/3 1/2"
 RU 7591-01

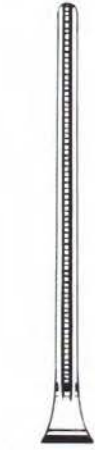

10,5 cm/4"
 RU 7591-02

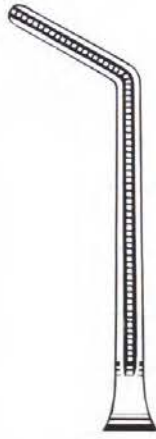

11 cm/4 1/2"
 RU 7591-09

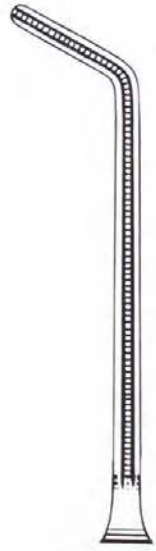

12 cm/4 3/4"
 RU 7591-11

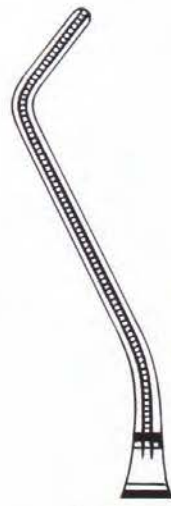

11,5 cm/4 1/2"
 RU 7591-92

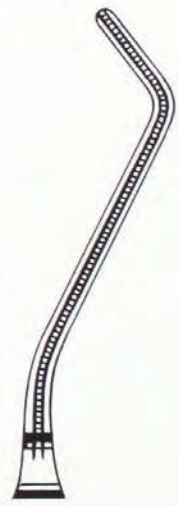

11,5 cm/4 1/2"
 RU 7591-94

TI = TITAN



Atrauma Bulldogklemmen
Atrauma Bulldog Clamps
Clamps Bulldog atraumaticos
Clamps atraumatiques Bulldog
Pinze atraumatiche Bulldog



Vena
Arteria

3 cm/1 1/4"
RU 7592-02/30V
RU 7592-02/30A

3,5 cm/1 1/2"
RU 7592-02/35V
RU 7592-02/35A

4 cm/1 1/2"
RU 7592-02/40V
RU 7592-02/40A

5 cm/2"
RU 7592-02/50V
RU 7592-02/50A



Vena
Arteria

3 cm/1 1/4"
RU 7592-03/30V
RU 7592-03/30A

3,5 cm/1 1/2"
RU 7592-03/35V
RU 7592-03/35A

4 cm/1 1/2"
RU 7592-03/40V
RU 7592-03/40A

5 cm/2"
RU 7592-03/50V
RU 7592-03/50A



Vena
Arteria

3 cm/1 1/4"
RU 7592-05/30V
RU 7592-05/30A

3,5 cm/1 1/2"
RU 7592-05/35V
RU 7592-05/35A

4 cm/1 1/2"
RU 7592-05/40V
RU 7592-05/40A

5 cm/2"
RU 7592-05/50V
RU 7592-05/50A



Coarctations-Klemmen
 Coarctation clamps
 Pinzas-clamps
 para coarctación
 Pinces-clamps
 pour la coarctation
 Pinze per
 coartazione

Rudolf
DE BAKEY



**Potts
 (De Bakey)**

21,5 cm/8½"
RU 7600-21
RU 7600-21 TI



22,5 cm/9"
RU 7600-22
RU 7600-22 TI



26 cm/10¼"
RU 7600-26

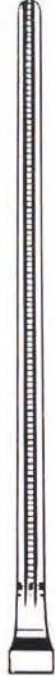

**Potts
 (De Bakey)**

21 cm/8¼"
RU 7601-21
RU 7601-21 TI



22 cm/8¾"
RU 7601-22
RU 7601-22 TI



25 cm/9¾"
RU 7601-26

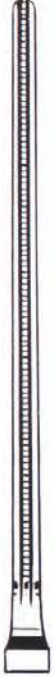

Sicherungsschloß
 Ratchet lock
 Cierre de seguridad
 Blocage de sécurité
 Chiusura di sicurezza



RU 7599-00



Potts



21 cm/8¼"
RU 7602-21



22 cm/8¾"
RU 7602-22



Atrauma Cardiovascular-Klemmen
 Atrauma Cardiovascular Forceps
 Pinzas-clamps cardiovasculares
 Pincas vasculaires atraumatiques
 Pinze cardiovascolari atraumatiche



Rudolf
 DE BAKEY

Anastomosens-Klemmen
 Anastomosis clamps
 Pinzas-clamps para anastomosis
 Pincas-clamps pour l'anastomose
 Pinze per anastomosi



Glover
 (Potts)

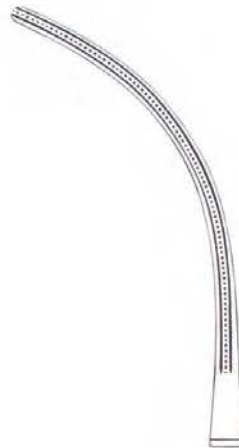

21 cm/8¼"
 RU 7603-21
 RU 7603-21 TI



21 cm/8¼"
 RU 7604-21
 RU 7604-21 TI

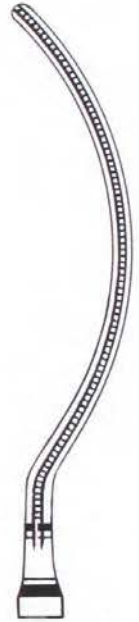

23,5 cm/9¼"
 RU 7604-24

Präparier- und Ligaturklemmen
 Dissecting and ligature forceps
 Pinzas para preparaciones y ligaduras
 Pincas à préparation et ligature
 Pinze per preparazioni e legature



De Bakey



20 cm/8"
 RU 7605-20

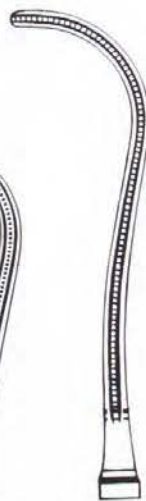

22 cm/8¾"
 RU 7605-24



19 cm/7½"
 RU 7609-20
 RU 7609-20 TI

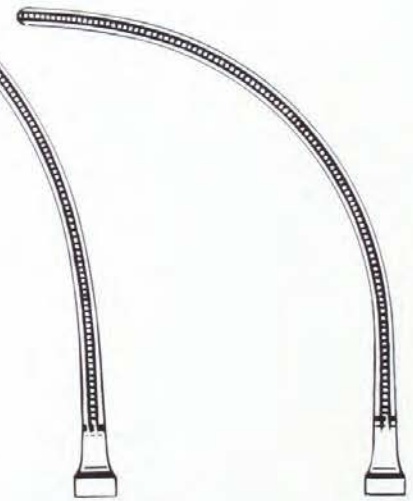

18 cm/7"
 RU 7609-19
 RU 7609-19 TI

TI = TITAN



rudolf
 DE BAKEY



Leland-Jones

19,5 cm/7½"
 RU 7610-01
 RU 7610-01 TI



19,5 cm/7½"
 RU 7610-02
 RU 7610-02 TI



18 cm/7"
 RU 7610-03
 RU 7610-03 TI

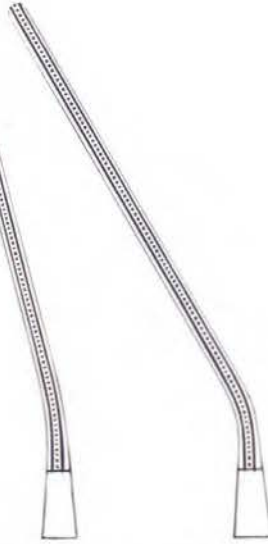

Leland-Jones
 18 cm/7"
 RU 7611-18
 RU 7611-18 TI



De Bakey-Bainbridge

15,5 cm/6"
 RU 7612-15



18 cm/7"
 RU 7612-18



15,5 cm/6"
 RU 7613-15



17 cm/6¾"
 RU 7613-18



De Bakey
 23 cm/9"
 RU 7615-20

TI = TITAN



Atrauma Cardiovascular-Klemmen
Atrauma Cardiovascular Forceps
Atrauma Pinzas-clamps cardiovasculares
Pincés vasculaires atraumatiques
Pinze cardiovascolari atraumatiche



Rudolf
DE BAKEY



Aorta-Aneurysmaklemmen
Aortic aneurysm clamps
Pinzas-clamps para
aneurisma de aorta
Pincés-clamps pour
l'anévrisme de l'aorte
Pinze per aneurisma
dell'aorta

25 cm/10"
RU 7618-24

27 cm/10½"
RU 7618-27

31 cm/12¼"
RU 7618-31

33,5 cm/13¼"
RU 7618-33

28 cm/11"
RU 7618-24 TI

30 cm/11¾"
RU 7618-27 TI

32 cm/12½"
RU 7618-31 TI

34 cm/13½"
RU 7618-33 TI

De Bakey

TI = TITAN



rudolf
DE BAKEY

Aorta-Aneurysmaklemmen
Aortic aneurysm clamps
Pinzas-clamps para
aneurisma de aorta
Pincers-clamps pour
l'anévrisme de l'aorte
Pinze per aneurisma
dell'aorta

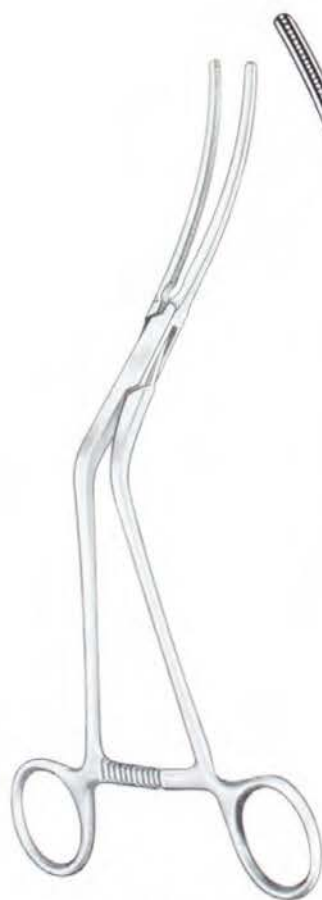

Wylie
24 cm/9½"
RU 7619-01



De Bakey
28 cm/11"
RU 7620-28



31 cm/12¼"
RU 7621-30



Atrauma Cardiovascular-Klemmen
Atrauma Cardiovascular Forceps
Atrauma Pinzas-clamps cardiovasculares
Pincés vasculaires atraumatiques
Pinze cardiovascolari atraumatiche



Rudolf
DE BAKEY

Aortaklemmen
Aortic clamps
Pinzas-clamps para aorta
Pincés-clamps pour l'aorte
Pinze per aorta



Ochsner
26 cm/10¼"
RU 7624-23



Diethrich
21 cm/8¼"
RU 7625-21



Rudolf
DE BAKEY

Aurikelklemmen
Auricle clamps
Pinzas-clamps auriculares
Pinces-clamps auriculaires
Pinze per padiglione
auricolare



Harken



25 cm/10"
RU 7627-01

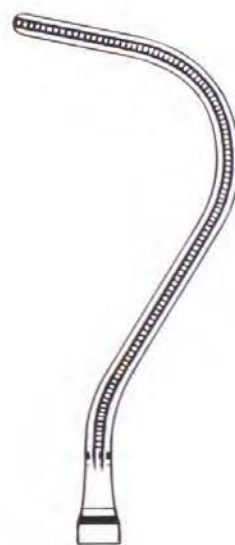

24 cm/9 1/2"
RU 7627-02



24 cm/9 1/2"
RU 7627-03



24 cm/9 1/2"
RU 7627-04



Atrauma Cardiovascular-Klemmen
Atrauma Cardiovascular Forceps
Atrauma Pinzas-clamps cardiovasculares
Pincers vasculaires atraumatiques
Pinze cardiovascolari atraumatiche



Rudolf
DE BAKEY

Bronchusklemmen
Bronchus clamps
Pinzas-clamps bronquiales
Pincers-clamps à bronches
Pinze per bronchi

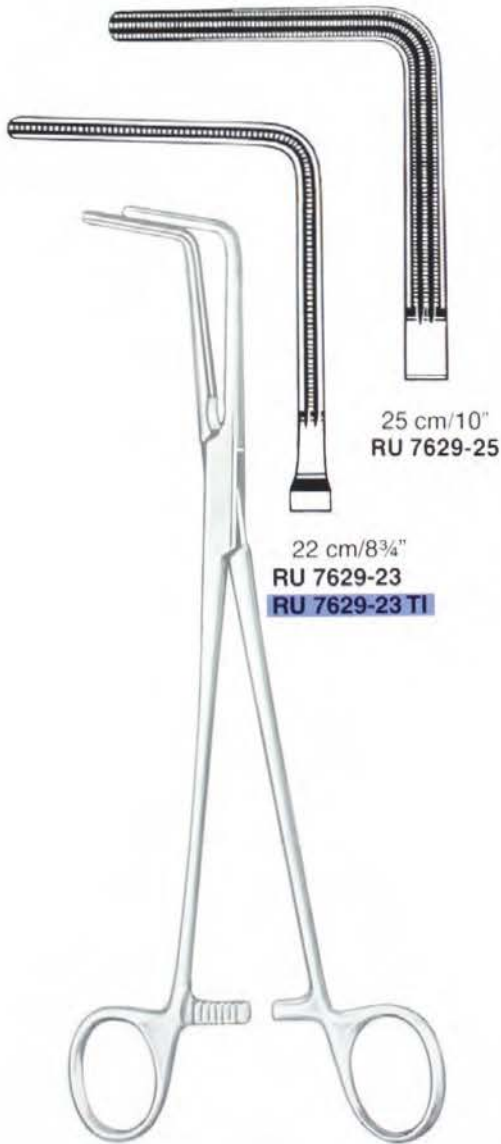

25 cm/10"
RU 7629-25

22 cm/8¾"
RU 7629-23
RU 7629-23 TI

Lees



Lees
24 cm/9½"
RU 7630-25
RU 7630-25 TI

TI = TITAN



Rudolf
 DE BAKEY

Aortaklemme
 Aortic clamps
 Pinzas-clamps para aorta
 Pincés-clamps pour l'aorte
 Pinze per aorte



Draufsicht
 Top view
 Vista de arriba
 Vue en plan
 Vista da sopra

De Bakey
 27 cm/10 1/2"
 RU 7632-27

Ligaturklemmen
 Ligature clamps
 Pinzas-clamps para ligadura
 Pincés-clamps pour la ligature
 Pinze per legature

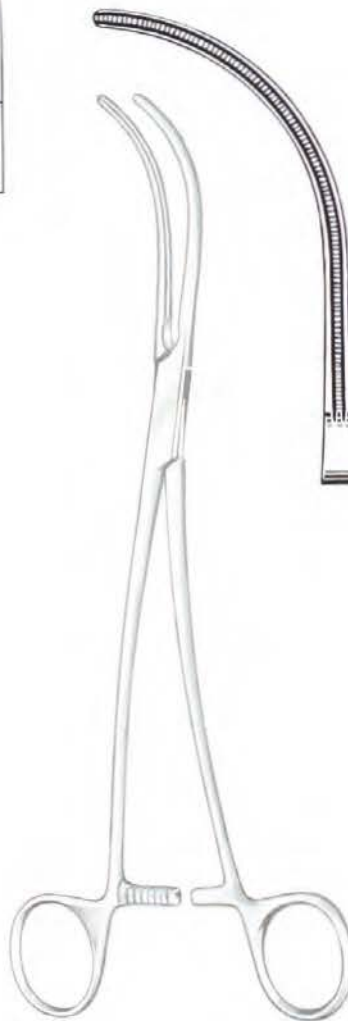

De Bakey
 24 cm/9 1/2"
 RU 7633-24



De Bakey
 24 cm/9 1/2"
 RU 7634-24



Atrauma Cardiovascular-Klemmen
Atrauma Cardiovascular Forceps
Atrauma Pinzas-clamps cardiovasculares
Pinces vasculaires atraumatiques
Pinze cardiovascolari atraumatiche



Rudolf
DE BAKEY

Ligaturklemme,
Aortaklemme
Ligature clamps,
Aortic clamps
Pinzas-clamps para ligadura y aorta
Pinces-clamps pour l'aorte et la ligature
Pinze per aorta e legature



De Bakey
27 cm/10½"
RU 7636-26
RU 7636-26 TI

De Bakey-Semb
27 cm/10½"
RU 7635-25

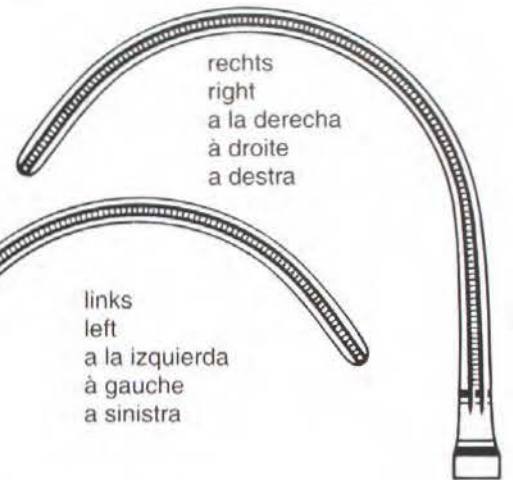

rechts
right
a la derecha
à droite
a destra

links
left
a la izquierda
à gauche
a sinistra

RU 7638-02

RU 7638-01



Aortaklemmen
Aortic clamps
Pinzas-clamps para aorta
Pinces-clamps pour l'aorte
Pinze per aorta

Weber
26 cm/10¼"



Satinsky-De Bakey

Rudolf
DE BAKEY

Tangentialklemmen
 Tangential occlusion clamps
 Pinzas-clamps para
 oclusión tangencial
 Pinces-clamps pour
 l'occlusion tangentielle
 Pinze per
 occlusione tangenziale

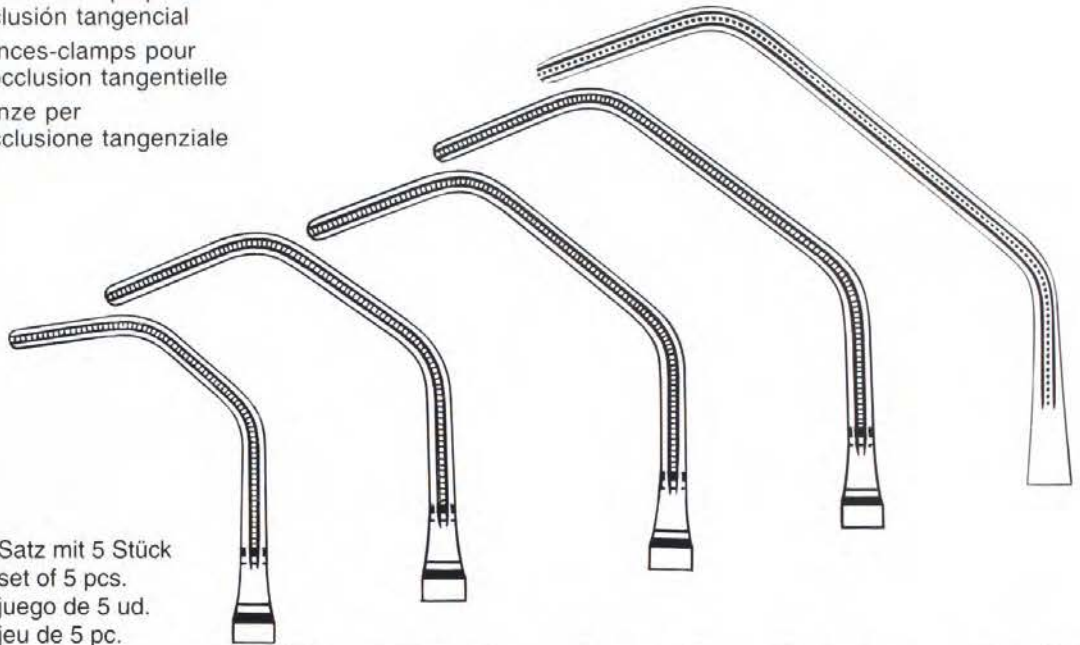

Satz mit 5 Stück
 set of 5 pcs.
 juego de 5 ud.
 jeu de 5 pc.
 set di

RU 7640-00	20 cm/8"	25 cm/10"	26 cm/10¼"	27 cm/10½"	28 cm/11"
RU 7640-00 TI	RU 7640-20 TI	RU 7640-25 TI	RU 7640-26 TI	RU 7640-27 TI	RU 7640-28 TI



Glover

RU 7646-01	19,5 cm/7¾"
RU 7646-02	21 cm/8¼"

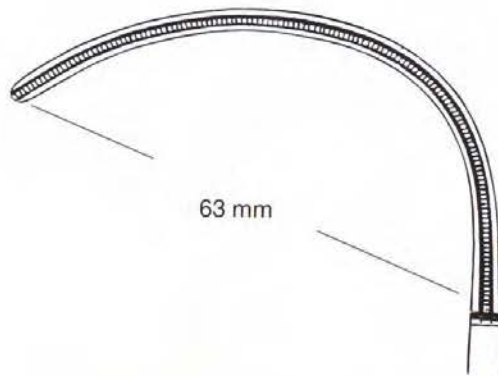

RU 7646-02

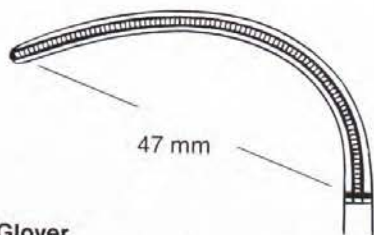

RU 7646-01

Anastomosenklemmen
 Anastomosis clamps
 Pinzas-clamps para anastomosis
 Pinces-clamps pour l'anastomose
 Pinze per anastomosi



Atrauma Cardiovascular-Klemmen
Atrauma Cardiovascular Forceps
Atrauma Pinzas-clamps cardiovasculares
Pincas vasculaires atraumatiques
Pinze cardiovascolari atraumatiche



Rudolf
DE BAKKEY



Lambert-Kay
21 cm/8¹/₄"

Aorta-Anastomosenklemmen
Aortic anastomosis clamps
Pinzas-clamps para anastomosis
Pincas-clamps pour l'anastomose de l'aorte
Pinze anastomosi aorta



RU 7648-21
RU 7648-21 TI

RU 7647-21
RU 7647-21 TI

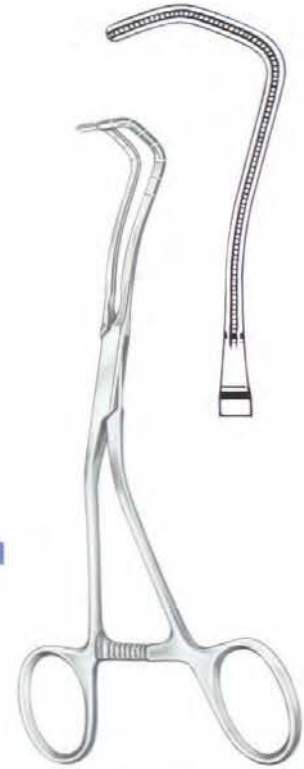

De Bakkey
17 cm/6³/₄"
RU 7649-17



Beck
16 cm/6¹/₄"
RU 7650-17
RU 7650-17 TI

TI = TITAN



rudolf
 DE BAKEY



De Bakey
 16 cm/6¼"
 RU 7651-16
 RU 7651-16 TI

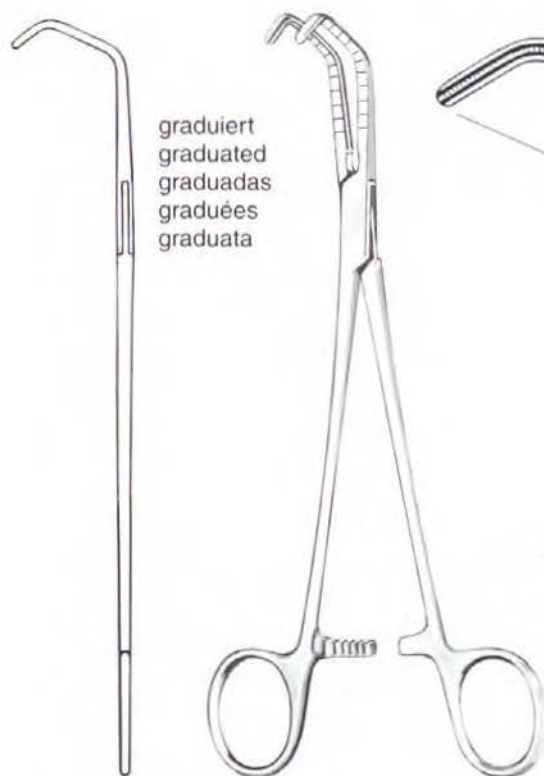

graduiert
 graduated
 graduadas
 graduées
 graduata

De Bakey-Beck
 RU 7653-01 20,5 cm/8"
 RU 7653-02 21 cm/8¼"



45 mm

RU 7653-02

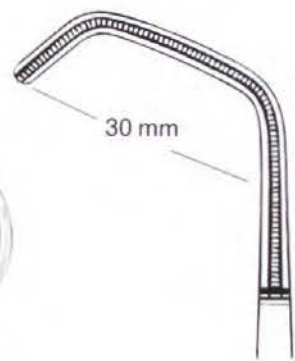

30 mm

RU 7653-01

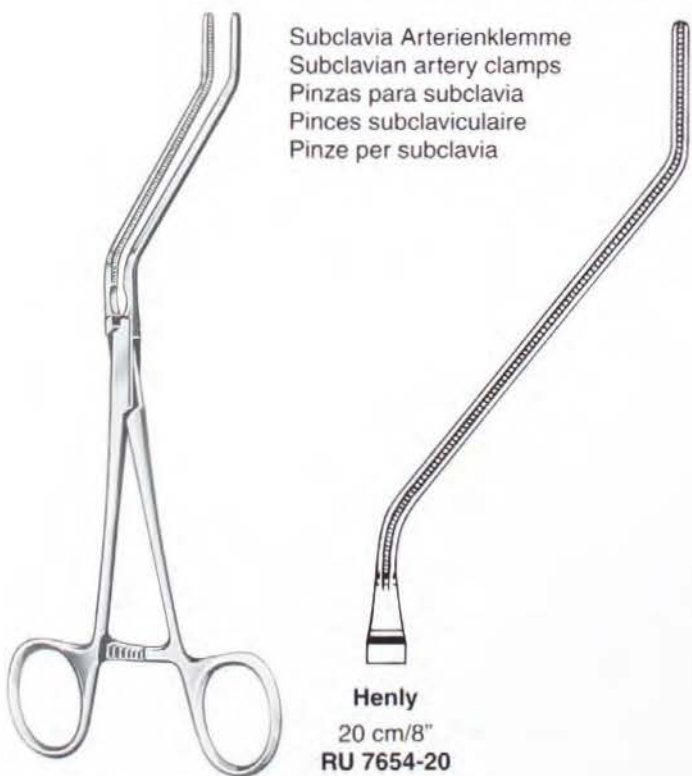

Subclavia Arterienklemme
 Subclavian artery clamps
 Pinzas para subclavia
 Pincés subclaviculaire
 Pinze per subclavia

Henly
 20 cm/8"
 RU 7654-20



Atrauma Cardiovascular-Klemmen
Atrauma Cardiovascular Forceps
Atrauma Pinzas-clamps cardiovasculares
Pincés vasculaires atraumatiques
Pinze cardiovascolari atraumatiche



RU 7657-00



15°
RU 7657-15

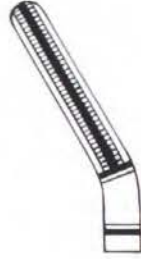

30°
RU 7657-30

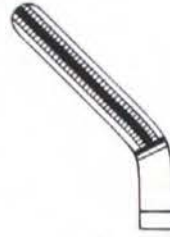

45°
RU 7657-45

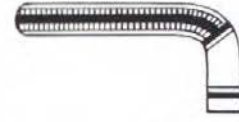

90°
RU 7657-90



RU 7658-00

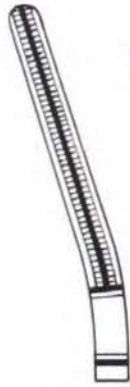

15°
RU 7658-15

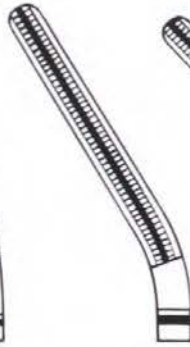

30°
RU 7658-30

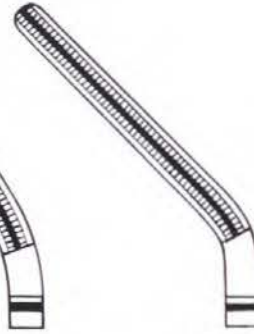

45°
RU 7658-45

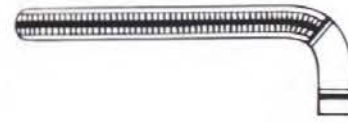

90°
RU 7658-90



Dardik

13 cm – 17 cm/5" – 6¾"



Rudolf
 DE BAKEY



Mehrzweckklemmen
 Multi purpose clamps
 Pinzas-clamps para
 usos varios
 Pincés-clamps à usage
 multiple
 Pinze per vari usi



De Bakey

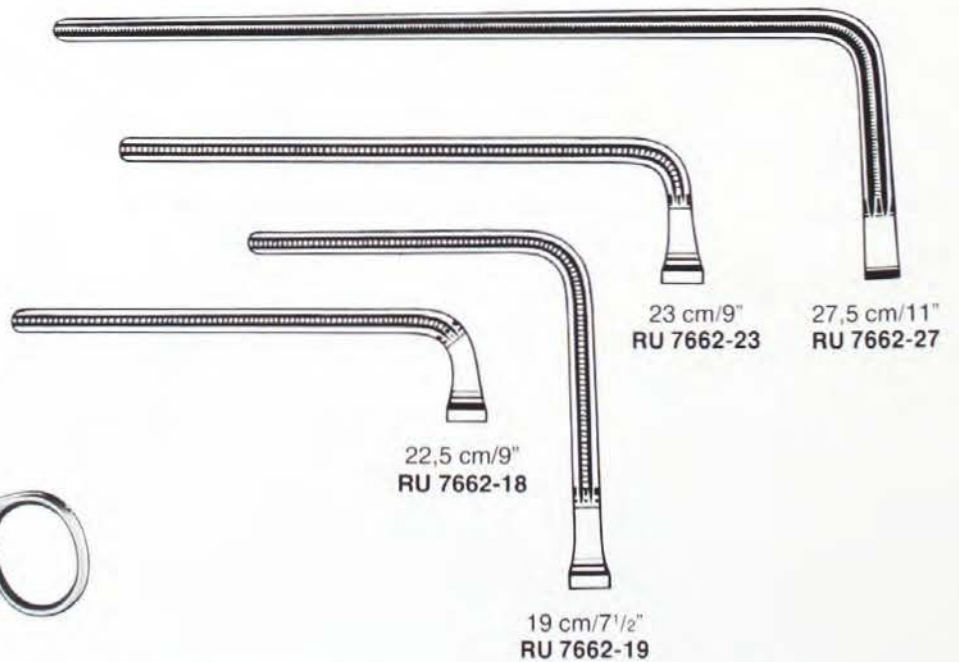



Atrauma Cardiovascular-Klemmen
Atrauma Cardiovascular Forceps
Atrauma Pinzas-clamps cardiovasculares
Pinces vasculaires atraumatiques
Pinze cardiovascolari atraumatiche



Rudolf
DE BAKEY

Aorta-Anastomosenklemmen
Aortic anastomosis clamps
Pinzas-clamps para anastomosis de aorta
Pinces-clamps pour l'anastomose de l'aorte
Pinze anastomosi aorta



Wertheim
24 cm/9½"

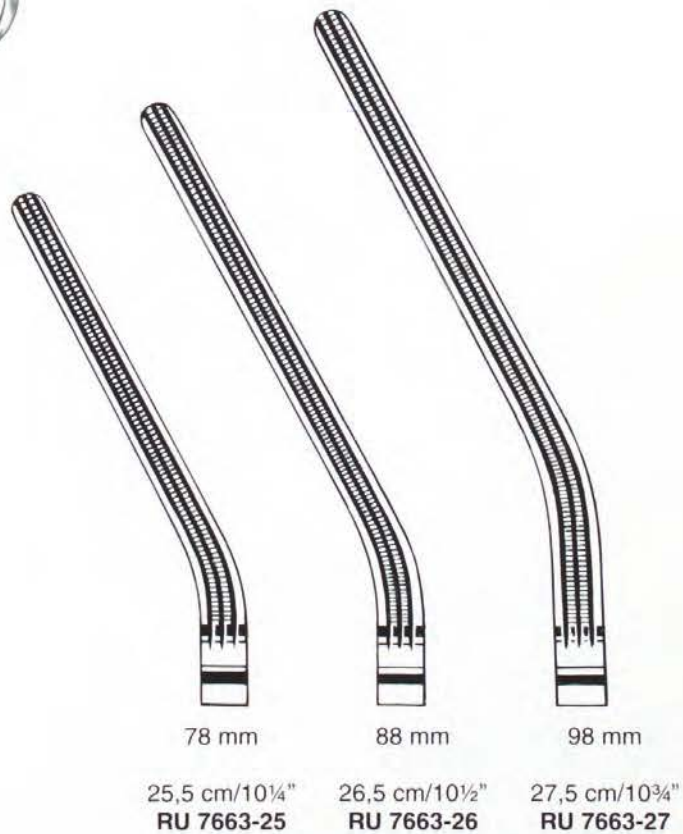
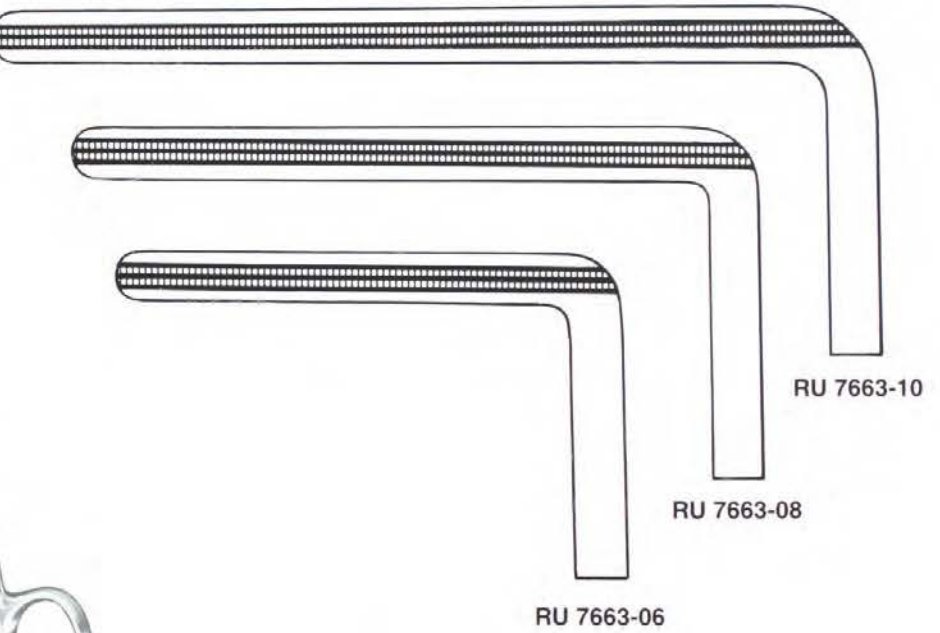

Dick

Atrauma Cardiovascular-Klemmen
Atrauma Cardiovascular Forceps
Atrauma Pinzas-clamps cardiovasculares
Pinces vasculaires atraumatiques
Pinze cardiovascolari atraumatiche



Rudolf
DE BAKEY

Aorta-Anastomosenklemmen
 Aortic anastomosis clamps
 Pinzas-clamps para anastomosis de aorta
 Pinces-clamps pour l'anastomose de l'aorte
 Pinze anastomosi aorta



Morris-De Bakey



26 cm/10¼"
RU 7664-23

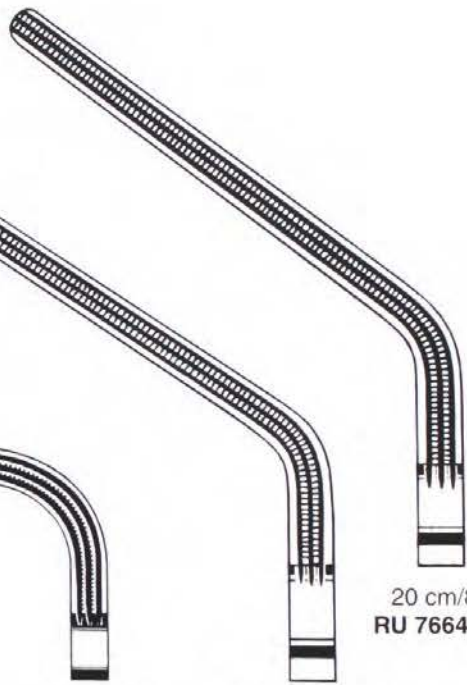

20 cm/8"
RU 7664-20

26,5 cm/10½"
RU 7664-25



Glover
 24,5 cm/9¾"
RU 7665-24





Atrauma Cardiovascular-Klemmen
Atrauma Cardiovascular Forceps
Atrauma Pinzas-clamps cardiovasculares
Pinces vasculaires atraumatiques
Pinze cardiovascolari atraumatiche



Rudolf
DE BAKEY

Aorta-Aneurysmenklemmen
 Aorta aneurysm clamps
 Pinzas-clamps para
 aneurisma de aorta
 Pinces-clamps pour
 l'anévrisme de l'aorte
 Pinze per aneurisma dell' aorta



De Bakey-Bahnson

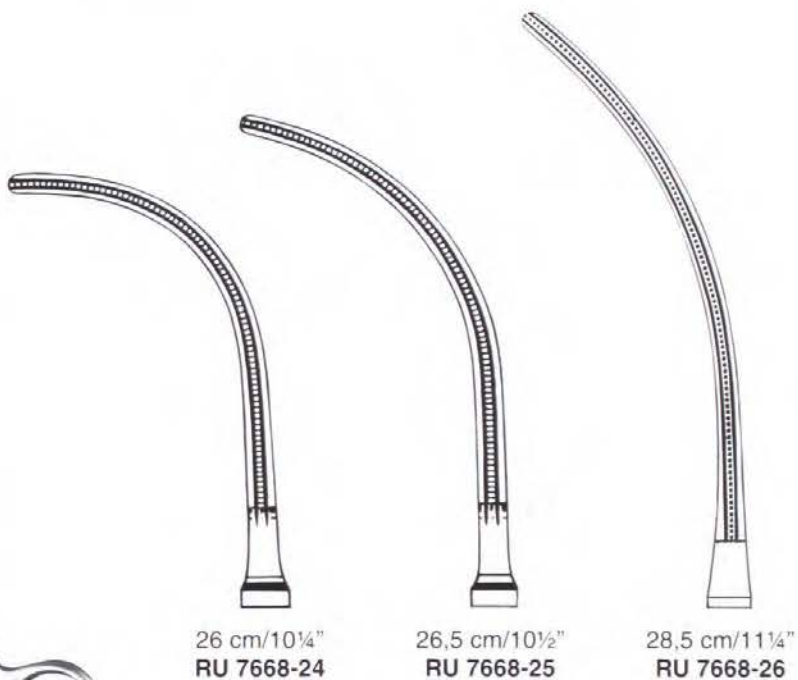

26 cm/10¼"
 RU 7668-24

26,5 cm/10½"
 RU 7668-25

28,5 cm/11¼"
 RU 7668-26

Coarctations-Klemmen
 Coarctation clamps
 Pinzas-clamps para coarctación
 Pinces-clamps pour la coarctation
 Pinze per coartazione



gerade
 straight
 rectas
 droites
 rette

gebogen
 curved
 curvas
 courbes
 curve

RU 7670-21	20 cm/8"	19,5 cm/7¾"	RU 7671-21
RU 7670-23	23 cm/9"	22,5 cm/8¾"	RU 7671-23
RU 7670-27	26 cm/10¼"	25,5 cm/10¼"	RU 7671-27
RU 7670-31	31,5 cm/12½"	31 cm/12¼"	RU 7671-31



Rudolf
 DE BAKEY



RU 7680-12 RU 7681-12

Mosquito
 12 cm/4³/₄"

Atrauma-Arterienklemmen
 Atrauma hemostatic forceps
 Pinzas hemostáticas atrauma
 Pinces hémostatiques atraumatiques
 Pinze emostatiche atraumatiche



De Bakey-Pean

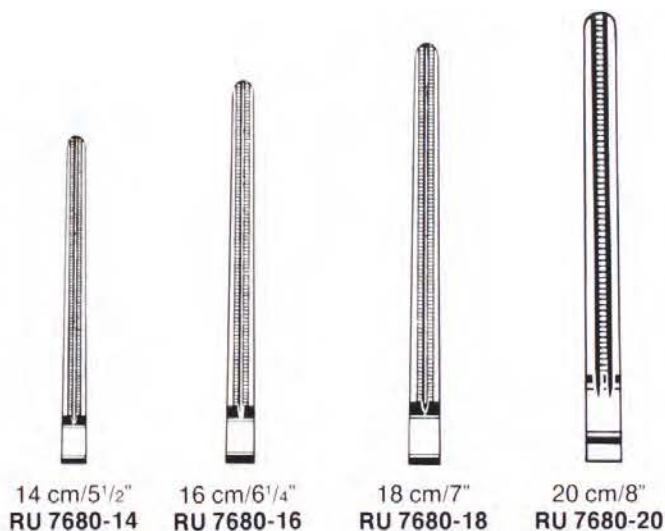

14 cm/5¹/₂" RU 7680-14
 16 cm/6¹/₄" RU 7680-16
 18 cm/7" RU 7680-18
 20 cm/8" RU 7680-20



14 cm/5¹/₂" RU 7681-14
 16 cm/6¹/₄" RU 7681-16
 17 cm/6³/₄" RU 7681-18
 20 cm/8" RU 7681-20



Atrauma Cardiovascular-Klemmen
Atrauma Cardiovascular Forceps
Atrauma Pinzas-clamps cardiovasculares
Pinces vasculaires atraumatiques
Pinze cardiovascolari atraumatiche



Rudolf
DE BAKEY

Mehrzweckklemmen
 Multi purpose clamps
 Pinzas-clamps para usos varios
 Pinces-clamps à usage multiple
 Pinze per vari usi

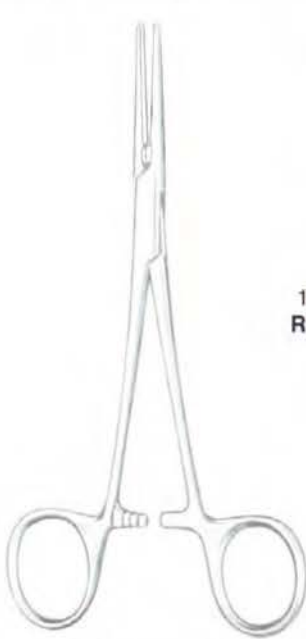

De Bakey-Rankin

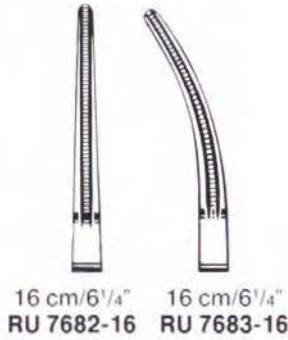

De Bakey



De Bakey
 17 cm/6³/₄"
 RU 7688-17



RU 7689-17

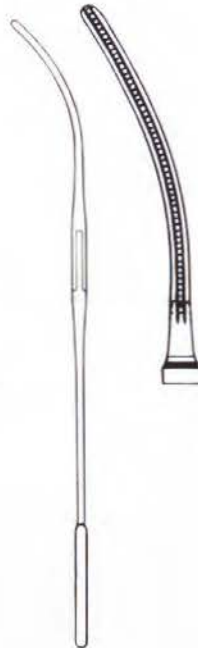

RU 7690-17



RU 7691-17

Ligaturklemmen
 Ligature clamps
 Pinzas-clamps para ligadura
 Pinces-clamps pour la ligature
 Pinze per legature



16 cm/6¹/₄" RU 7692-16
 16,5 cm/6¹/₂" RU 7692-17



Rudolf
 DE BAKEY

Peripheral-Gefäßklemmen
 Peripheral vessel clamps
 Pinzas-clamps periféricas
 Pincés-clamps périphériques
 Pinze periferiche

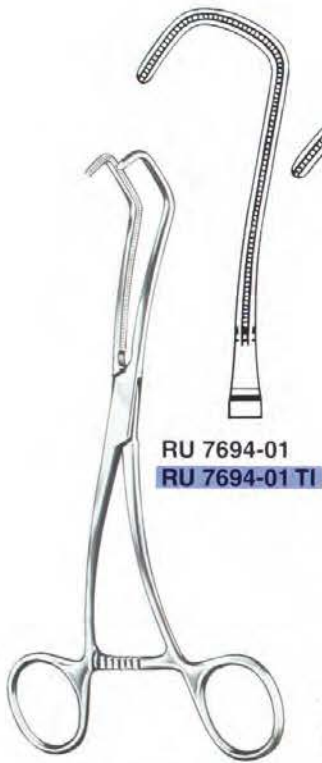

RU 7694-01
 RU 7694-01 TI

Derra-De Bakey
 17 cm/6³/₄"

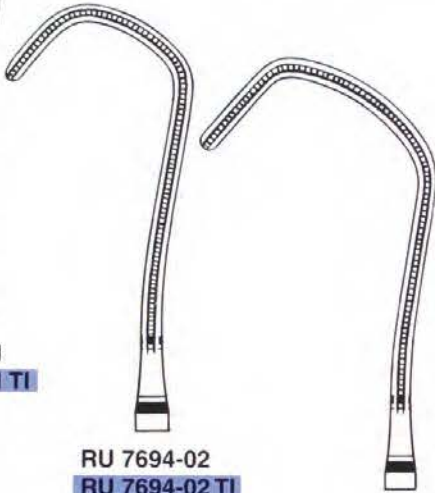

RU 7694-02
 RU 7694-02 TI

RU 7694-03
 RU 7694-03 TI

Anastomosenklemmen
 Anastomosis clamps
 Pinzas-clamps para anastomosis
 Pincés-clamps pour l'anastomose
 Pinze per anastomosi

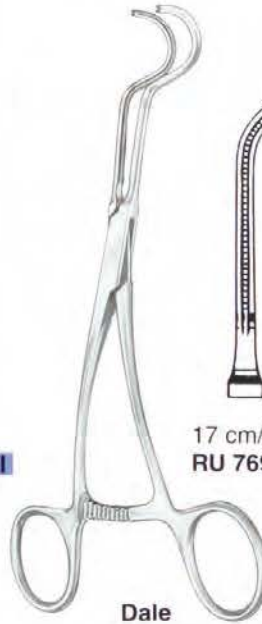

17 cm/6³/₄"
 RU 7695-41

Dale

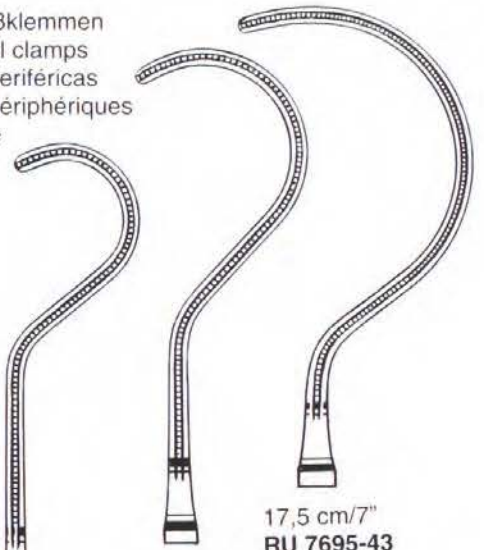

17,5 cm/7"
 RU 7695-42

17,5 cm/7"
 RU 7695-43

Profundaklemmen
 Profunda clamps
 Pinzas-clamps profundales
 Pincés-clamps profundales
 Pinze per profondità



14,5 cm/5¹/₂"
 RU 7698-14

Gregory

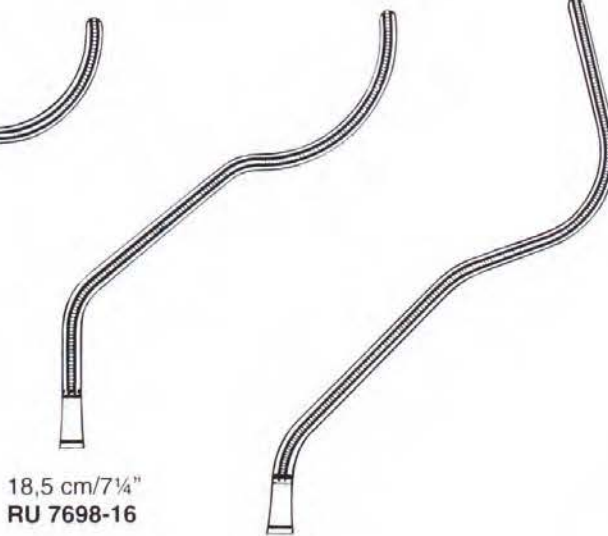

18,5 cm/7¹/₄"
 RU 7698-16

19,5 cm/7³/₄"
 RU 7698-18



15 cm/6"
 RU 7699-15
 RU 7699-15 TI

Subramanian-Miniature

TI = TITAN



Atrauma Cardiovascular-Klemmen
Atrauma Cardiovascular Forceps
Atrauma Pinzas-clamps cardiovasculares
Pincers vasculaires atraumatiques
Pinze cardiovascolari atraumatiche



Rudolf
DE BAKEY



De Bakey
13 cm/5"
RU 7701-12

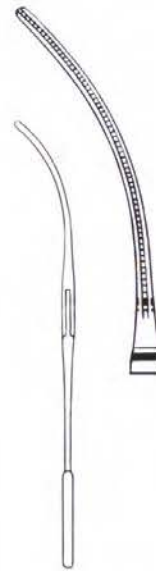

12,5 cm/5"
RU 7702-11



13 cm/5"
RU 7703-12



12,5 cm/5"
RU 7704-13



10 cm/4"
RU 7705-10



Rudolf
 DE BAKEY



RU 7706-01
 RU 7706-01 TI



RU 7706-03
 RU 7706-03 TI



RU 7706-05
 RU 7706-05 TI

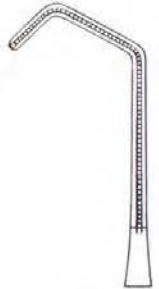

RU 7706-08
 RU 7706-08 TI



RU 7706-09
 RU 7706-09 TI

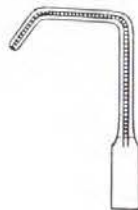

RU 7706-10
 RU 7706-10 TI



RU 7706-13
 RU 7706-13 TI



RU 7706-15
 RU 7706-15 TI



De Bakey-Castaneda
 12 cm/4¾"

TI = TITAN



Frühgeborenen Mikro-Gefäßklemmen
Micro Vascular Clamps for Prematures
Micro pinzas-clamps vasculares para niños prematuros
Clamps micro-vasculaires pour des prématurés
Pinze micro vascolari atraumatiche per prematuri



Rudolf
DE BAKEY



10,5 cm/4¼"

RU 7708-50

RU 7708-50 TI



10,5 cm/4¼"

RU 7708-52

RU 7708-52 TI



12,0 cm/4¾"

RU 7708-54

RU 7708-54 TI



10,5 cm/4¼"

RU 7708-56

RU 7708-56 TI



10,5 cm/4¼"

RU 7708-58

RU 7708-58 TI



10,5 cm/4¼"

RU 7708-60

RU 7708-60 TI

TI = TITAN



Rudolf
 DE BAKEY



komplett
 complete
 completo
 complet
 completo

RU 7709-00

Inhalt

- 1 x RU 6059-63 Micro-Ryder Nadelhalter
- 1 x RU 1316-14 Metzenbaum-Fino Schere
- 1 x RU 3328-14 Baby-Mixer Klemme
- 1 x **RU 7530-00 TI** Neonatal Titan Sternensperrer
- 1 x RU 7702-11 De Bakey Atrauma Klemme
- 1 x RU 7701-12 De Bakey Atrauma Klemme
- 1 x RU 7704-13 De Bakey Atrauma Klemme
- 1 x RU 7706-01 De Bakey-Castaneda Klemme
- 1 x RU 7706-08 De Bakey-Castaneda Klemme
- 1 x **RU 7580-10/15 TI** De Bakey Titan Pinzette
- 1 x RU 8904-07/01 Etui

Content

- 1 x RU 6059-63 needle holder Micro-Ryder
- 1 x RU 1316-14 scissors Metzenbaum-Fino
- 1 x RU 3328-14 forceps Baby-Mixer
- 1 x **RU 7530-00 TI** sternum spreader for newborns, titanium
- 1 x RU 7702-11 atraumatic clamps De Bakey
- 1 x RU 7701-12 atraumatic clamps De Bakey
- 1 x RU 7704-13 atraumatic clamps De Bakey
- 1 x RU 7706-01 clamps De Bakey-Castaneda
- 1 x RU 7706-08 clamps De Bakey-Castaneda
- 1 x **RU 7580-10/15 TI** dissecting forceps De Bakey, titanium
- 1 x RU 8904-07/01 case

Contenido

- 1 x RU 6059-63 porta-agujas Micro-Ryder
- 1 x RU 1316-14 tijera Metzenbaum-Fino
- 1 x RU 3328-14 pinza Baby-Mixer
- 1 x **RU 7530-00 TI** separador de esternón para recién nacidos de titanio
- 1 x RU 7702-11 atrauma pinza-clamp De Bakey
- 1 x RU 7701-12 atrauma pinza-clamp De Bakey
- 1 x RU 7704-13 atrauma pinza-clamp De Bakey
- 1 x RU 7706-01 pinza-clamp De Bakey-Castaneda
- 1 x RU 7706-08 pinza clamp De Bakey-Castaneda
- 1 x **RU 7580-10/15 TI** pinza de disección De Bakey, de titanio
- 1 x RU 8904-07/01 estuche

Contenu

- 1 x RU 6059-63 porte-aiguille Micro-Ryder
- 1 x RU 1316-14 ciseaux Metzenbaum-Fino
- 1 x RU 3328-14 pince Baby-Mixer
- 1 x **RU 7530-00 TI** écarteur à sternum néonatal, en titane
- 1 x RU 7702-11 pincés-clamps atraumatiques De Bakey
- 1 x RU 7701-12 pincés-clamps atraumatiques De Bakey
- 1 x RU 7704-13 pincés-clamps atraumatiques De Bakey
- 1 x RU 7706-01 pincés-clamps De Bakey-Castaneda
- 1 x RU 7706-08 pincés-clamps De Bakey-Castaneda
- 1 x **RU 7580-10/15 TI** pince à disséquer De Bakey, en titane
- 1 x RU 8904-07/01 boîte

Contenuto

- 1 x RU 6059-63 Portaghi Micro-Ryder
- 1 x RU 1316-14 Forbici Metzenbaum-Fino
- 1 x RU 3328-14 Pinze Baby-Mixer
- 1 x **RU 7530-00 TI** Divaricatore per sterno per neonati, titanio
- 1 x RU 7702-11 Pinze cardiovascolari atraumatiche, titanio De Bakey
- 1 x RU 7701-12 Pinze cardiovascolari atraumatiche, titanio De Bakey
- 1 x RU 7704-13 Pinze cardiovascolari atraumatiche, titanio De Bakey
- 1 x RU 7706-01 Pinze cardiovascolari atraumatiche, titanio De Bakey
- 1 x RU 7706-08 Pinze cardiovascolari atraumatiche, titanio De Bakey
- 1 x **RU 7580-10/15 TI** Pinze De Bakey atraumatiche titanio
- 1 x RU 8904-07/01 Scatole

TI = TITAN



Atrauma Cardiovascular-Klemmen
 Atrauma Cardiovascular Forceps
 Atrauma Pinzas-clamps cardiovasculares
 Pincers vasculaires atraumatiques
 Pinze cardiovascolari atraumatiche



Rudolf
 COOLEY

Karotisklemmen
 Carotid clamps
 Pinzas-clamps
 para carotis
 Pincers-clamps
 pour la carotide
 Pinze per la
 carotide

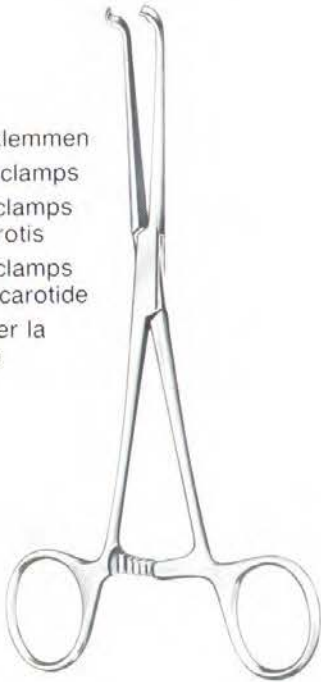

Javid
 15,5 cm/6"
 RU 7710-18



Javid
 18 cm/7"
 RU 7710-19



Cooley

Charrière (French)	Länge length largo longueur lunghezza cm	
24	16	RU 7711-24
26	16	RU 7711-26
28	19	RU 7711-28
30	19	RU 7711-30
32	19	RU 7711-32
36	19	RU 7711-36

Atrauma Bulldogklemmen
Atrauma Bulldog Clamps
Clamps Bulldog atraumaticos
Pinces-clamps bulldog atraumatiques
Pinze atraumatiche Bulldog



Rudolf
COOLEY



**Cooley
 Glover**

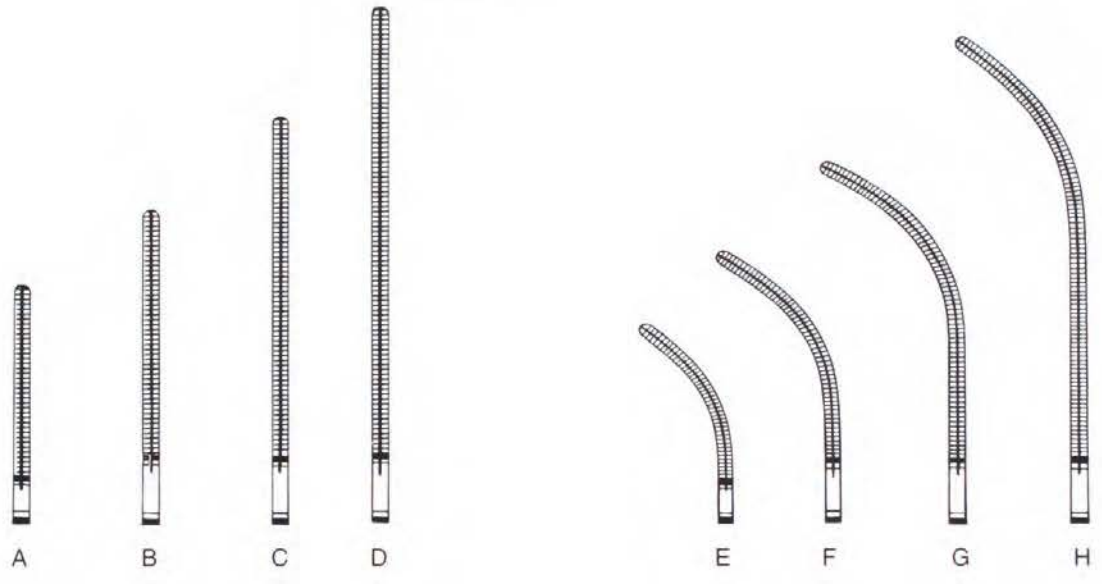
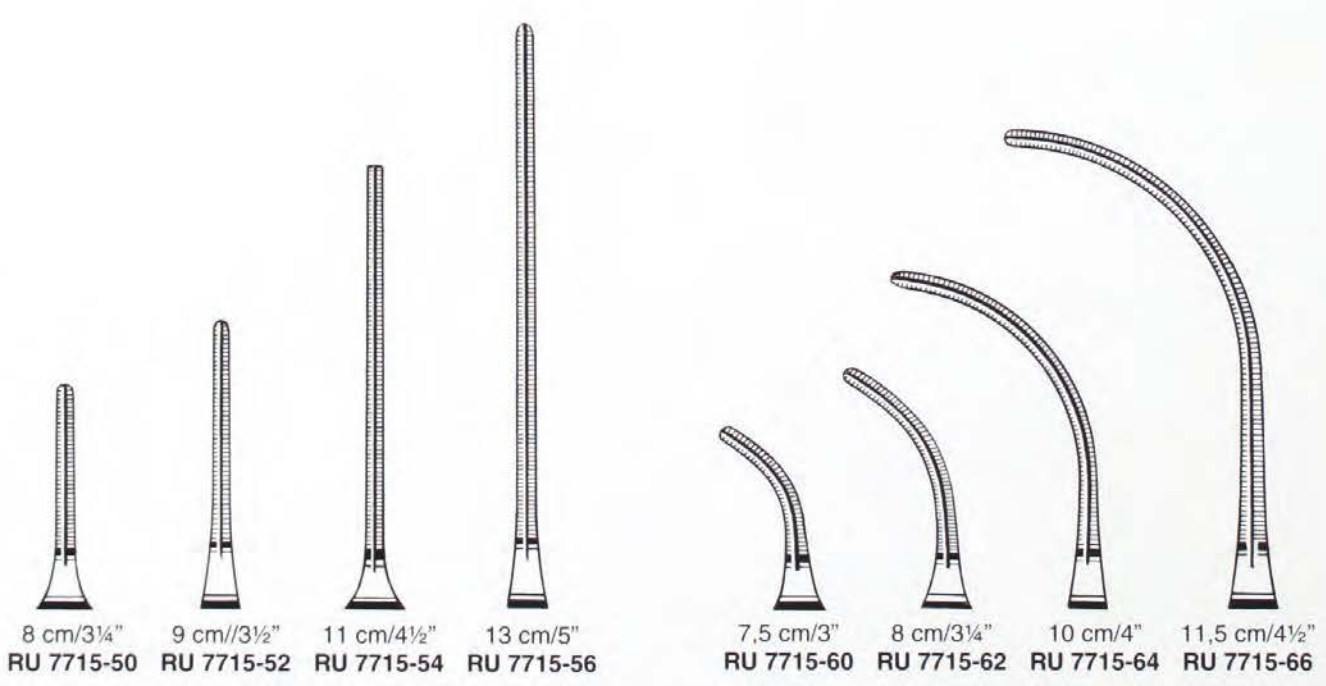

Fig.	Gesamtlänge overall length largo total longueur totale lunghezza totale (mm)	Maullänge jaw length largo de boca longueur du mos lunghezza del morso (mm)	Artikel-Nr. Article No. Referencia Référence No. art.
A	70	20	RU 7715-40
B	80	30	RU 7715-41
C	95	43	RU 7715-42
D	115	56	RU 7715-43

Fig.	Gesamtlänge overall length largo total longueur totale lunghezza totale (mm)	Maullänge jaw length largo de boca longueur du mos lunghezza del morso (mm)	Artikel-Nr. Article No. Referencia Référence No. art.
E	65	20	RU 7715-45
F	75	30	RU 7715-46
G	85	43	RU 7715-47
H	105	56	RU 7715-48



Cooley



8 cm/3¼" **RU 7715-50** 9 cm/3½" **RU 7715-52** 11 cm/4½" **RU 7715-54** 13 cm/5" **RU 7715-56**

7,5 cm/3" **RU 7715-60** 8 cm/3¼" **RU 7715-62** 10 cm/4" **RU 7715-64** 11,5 cm/4½" **RU 7715-66**



Atrauma Cardiovascular-Klemmen
Atrauma Cardiovascular Forceps
Atrauma Pinzas-clamps cardiovasculares
Pinces vasculaires atraumatiques
Pinze cardiovascolari atraumatiche



rudolf
COOLEY

Coarctationsklemmen
Coarctation clamps
Pinzas-clamps para coarctación
Pinces-clamps pour la coarctation
Pinze per coartazione

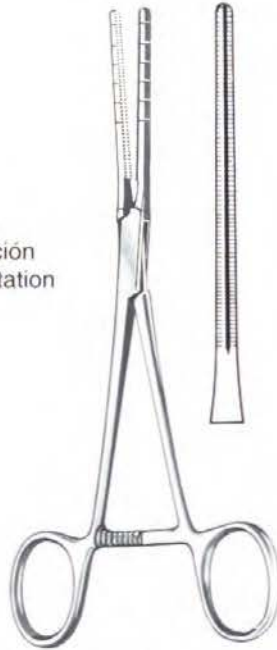

Cooley
17 cm/6³/₄"
RU 7721-17
RU 7721-17 TI

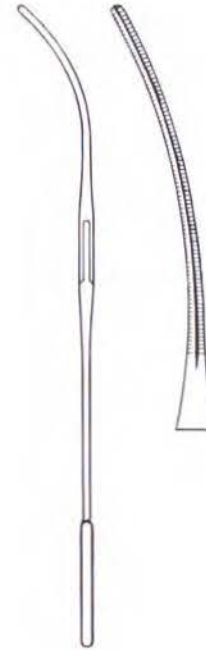

17 cm/6³/₄"
RU 7722-17
RU 7722-17 TI

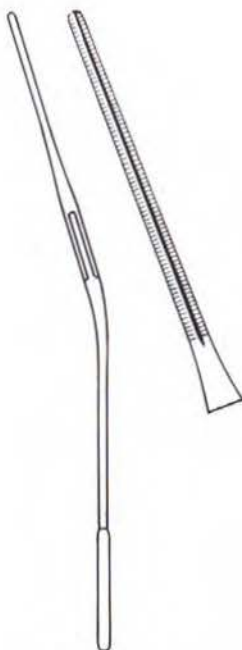

17 cm/6³/₄"
RU 7723-17
RU 7723-17 TI

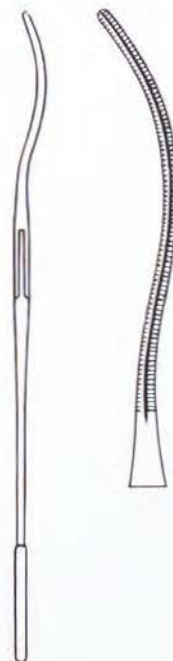

17,5 cm/7"
RU 7724-17
RU 7724-17 TI

TI = TITAN

Rudolf
 COOLEY

Mehrzweckklemmen
 Multi purpose clamps
 Pinzas-clamps para usos varios
 Pincers-clamps à usage multiple
 Pinze per vari usi



Cooley

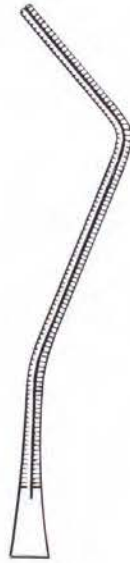

18 cm/7"
 RU 7726-18
 RU 7726-18 TI



20 cm/8"
 RU 7726-20
 RU 7726-20 TI

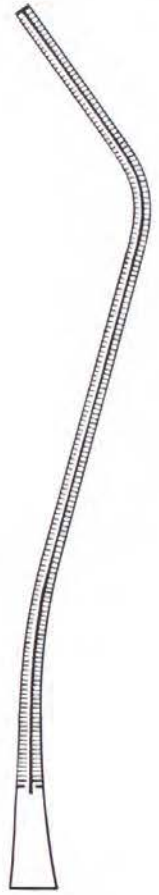

27 cm/10½"
 RU 7726-27
 RU 7726-27 TI



Cooley

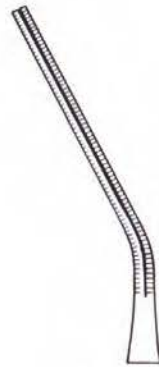

16,5 cm/6½"
 RU 7728-17
 RU 7728-17 TI

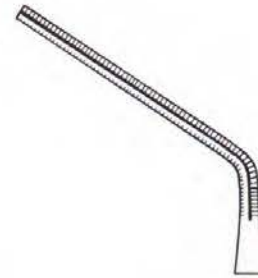

15,5 cm/6"
 RU 7729-15
 RU 7729-15 TI



13,5 cm/5¼"
 RU 7730-15
 RU 7730-15 TI

TI = TITAN



Atrauma Cardiovascular-Klemmen
Atrauma Cardiovascular Forceps
Atrauma Pinzas-clamps cardiovasculares
Pinces vasculaires atraumatiques
Pinze cardiovascolari atraumatiche



Rudolf
COOLEY



Cooley
26,5 cm/10 $\frac{1}{4}$ "
RU 7731-01



Cooley

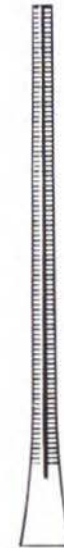

21,5 cm/8 $\frac{1}{2}$ "
RU 7731-04



25 cm/10"
RU 7731-05



Cooley
16 cm/6 $\frac{1}{4}$ "
RU 7734-17

Anastomosenklemmen
 Anastomosis clamps
 Pinzas-clamps para anastomosis
 Pincers-clamps pour l'anastomose de l'aorte
 Pinze per anastomosi

rudolf
 COOLEY



Cooley
 16,5 cm/6 1/2"

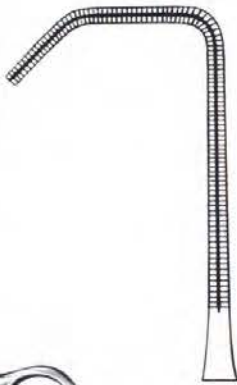

RU 7735-16

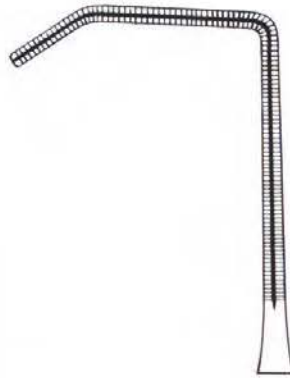

RU 7736-16

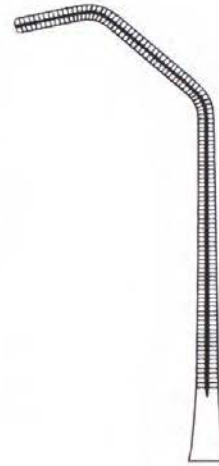

RU 7737-17



RU 7738-17



Cooley

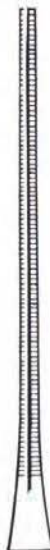

22,5 cm/8 3/4"
 RU 7739-01

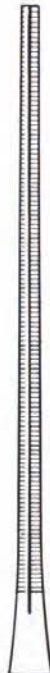

24,5 cm/9 3/4"
 RU 7739-03



Cooley



22 cm/8 3/4"
 RU 7739-05

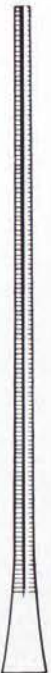

24 cm/9 1/2"
 RU 7739-07



Atrauma Cardiovascular-Klemmen
Atrauma Cardiovascular Forceps
Atrauma Pinzas-clamps cardiovasculares
Pincers vasculaires atraumatiques
Pinze cardiovascolari atraumatiche



rudolf
COOLEY

Cooley
22 cm/8³/₄"
RU 7739-22



Cooley
25,5 cm/10¹/₄"
RU 7739-26



Cooley
16 cm/6¹/₄"
RU 7740-16



Beck
17 cm/6³/₄"
RU 7741-17

Rudolf
 COOLEY

Tangentialklemmen
 Tangential occlusion clamps
 Pinzas-clamps para oclusión tangencial
 Pincers-clamps pour l'occlusion tangentielle
 Pinze per occlusione tangenziale



Cooley

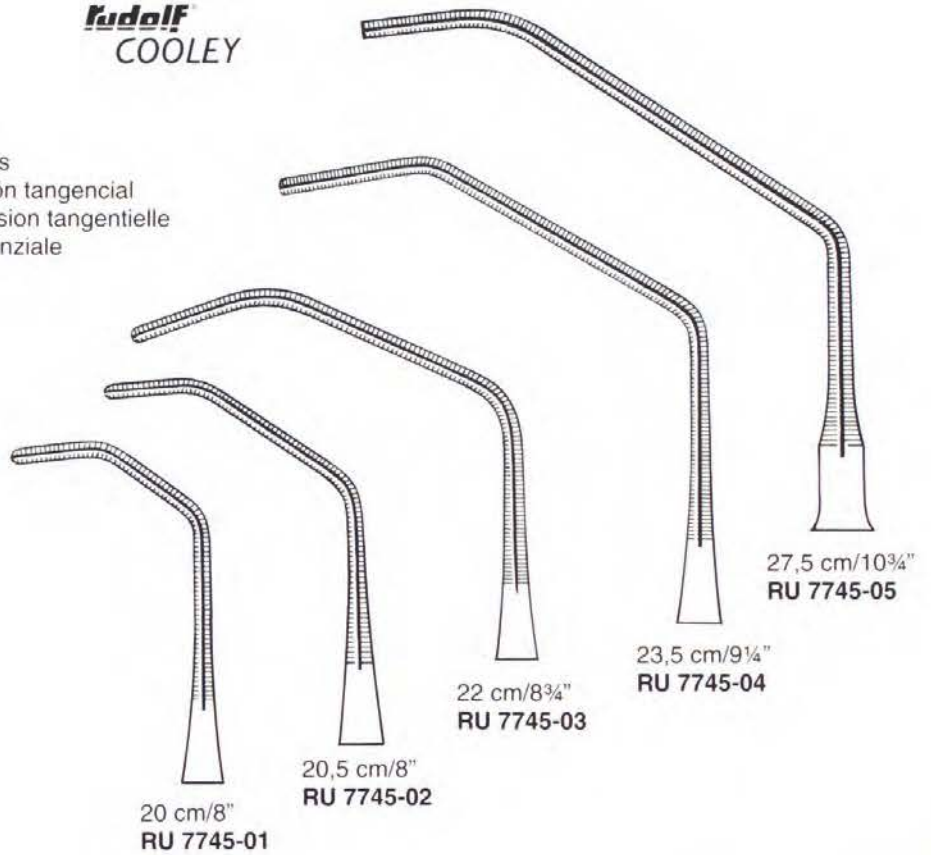

Ligaturklemmen
 Ligature clamps
 Pinzas-clamps para ligadura
 Pincers-clamps pour la ligature
 Pinze per legature

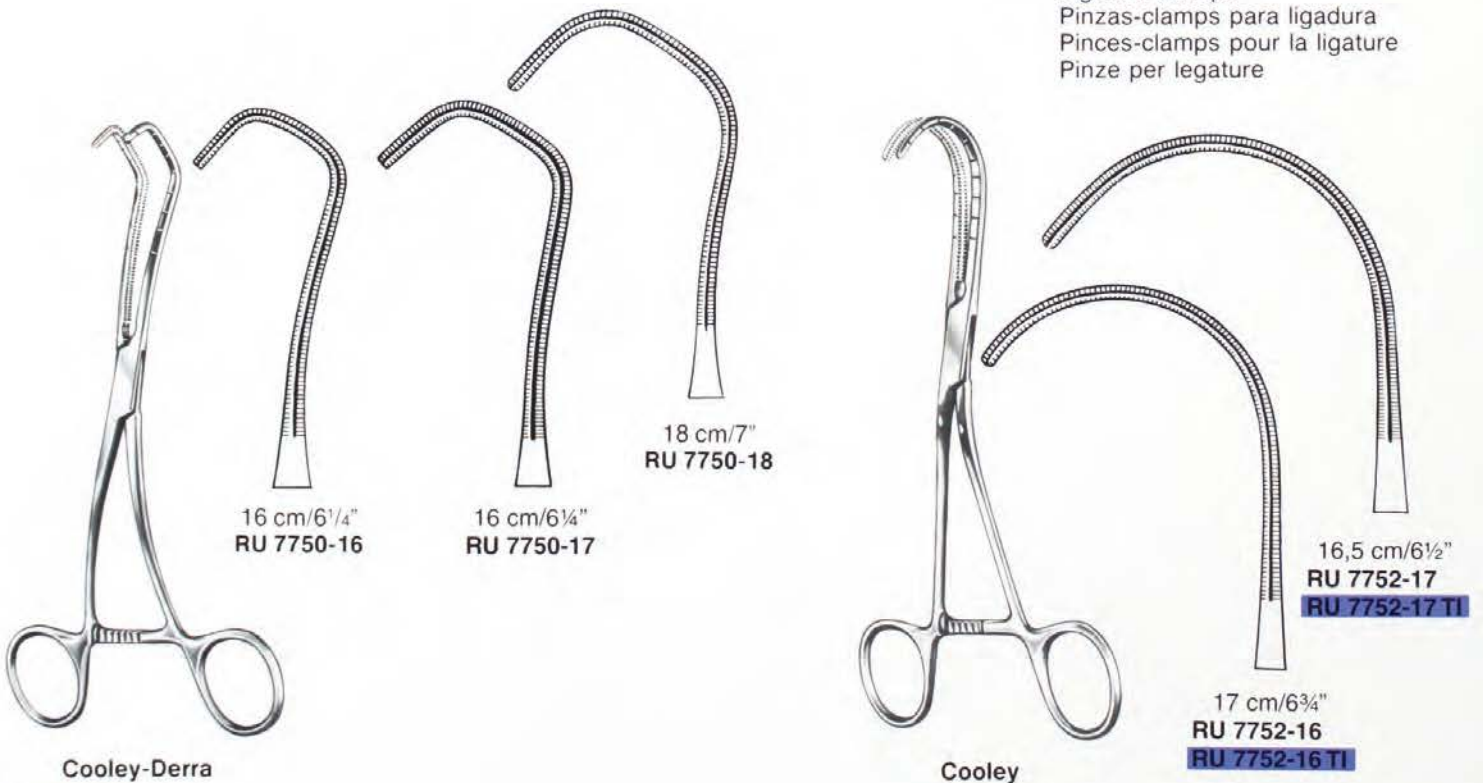

TI = TITAN



Atrauma Kinderklemmen
Atrauma Pediatric Clamps
Atrauma Pinzas-clamps pediatricos
Pinces-clamps atraumatiques pour la pédiatrie
Pinze cardiovascolari atraumatiche per bambini



Rudolf
COOLEY

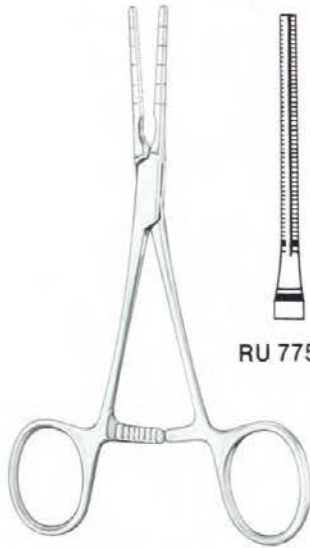

RU 7754-01

Cooley
14 cm/5 1/2"



RU 7754-02



Cooley
14 cm/5 1/2"
RU 7754-03

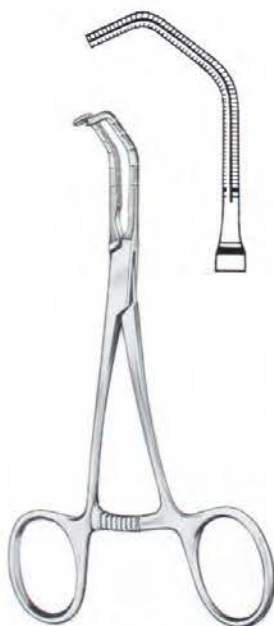

Cooley
14 cm/5 1/2"
RU 7754-04



Cooley
14 cm/5 1/2"
RU 7754-05

Rudolf
 COOLEY



Cooley
 12,5 cm/5"
 RU 7754-10



Cooley
 12,5 cm/5"
 RU 7754-11



Cooley
 12,5 cm/5"
 RU 7754-12



Cooley
 12,5 cm/5"
 RU 7754-14

graduiert
 graduated
 graduada
 graduée
 graduata

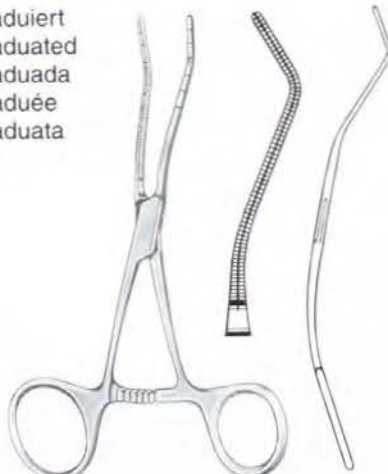

Cooley
 12,5 cm/5"
 RU 7754-15

graduiert
 graduated
 graduada
 graduée
 graduata



Cooley
 12,5 cm/5"
 RU 7754-18



Neonatal- und Kinderklemmen
 Neonatal and Pediatric Clamps
 Pinzas-clamps pediátricos y para recién nacidos
 Pinces-clamps pour des enfants et nouveaux-nés
 Pinze per neonati e bambini



rudolf
 COOLEY



ca. 15 cm



Fig.

1

2

3

4

5



Fig.

6

7

8

9

gerade
 straight
 rectas
 droites
 rette

abgewinkelt
 angled
 acodadas
 coudées
 angolari

gebogen
 curved
 curvas
 courbes
 curve

Fig.

- 1 RU 7755-01
- 2 RU 7755-02
- 3 RU 7755-03
- 4 RU 7755-04
- 5 RU 7755-05
- 6 RU 7755-06
- 7 RU 7755-07
- 8 RU 7755-08
- 9 RU 7755-09



Fig.

- 1 RU 7756-01
- 2 RU 7756-02
- 3 RU 7756-03
- 4 RU 7756-04
- 5 RU 7756-05
- 6 RU 7756-06
- 7 RU 7756-07
- 8 RU 7756-08
- 9 RU 7756-09

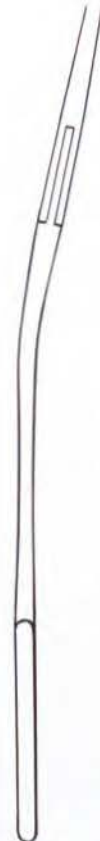

Fig.

- 1 RU 7757-01
- 2 RU 7757-02
- 3 RU 7757-03
- 4 RU 7757-04
- 5 RU 7757-05
- 6 RU 7757-06
- 7 RU 7757-07
- 8 RU 7757-08
- 9 RU 7757-09



rudolf
 COOLEY



ca. 9 cm



Fig.



Fig.

gerade
 straight
 rectas
 droites
 rette

abgewinkelt
 angled
 acodadas
 coudées
 angolari

gebogen
 curved
 curvas
 courbes
 curve

Fig.

- | | |
|---|------------|
| 1 | RU 7755-11 |
| 2 | RU 7755-12 |
| 3 | RU 7755-13 |
| 4 | RU 7755-14 |
| 5 | RU 7755-15 |
| 6 | RU 7755-16 |
| 7 | RU 7755-17 |
| 8 | RU 7755-18 |
| 9 | RU 7755-19 |



- | | |
|---|------------|
| 1 | - |
| 2 | - |
| 3 | RU 7756-13 |
| 4 | - |
| 5 | RU 7756-15 |
| 6 | RU 7756-16 |
| 7 | RU 7756-17 |
| 8 | RU 7756-18 |
| 9 | RU 7756-19 |

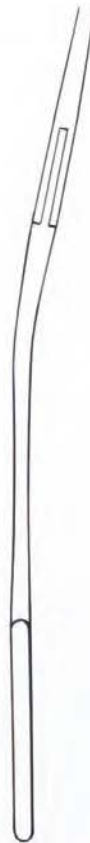

Fig.

- | | |
|---|------------|
| 1 | RU 7757-11 |
| 2 | RU 7757-12 |
| 3 | RU 7757-13 |
| 4 | RU 7757-14 |
| 5 | RU 7757-15 |
| 6 | RU 7757-16 |
| 7 | RU 7757-17 |
| 8 | RU 7757-18 |
| 9 | RU 7757-19 |





Cooley Neonatal Instrumenten-Set
Cooley Neonatal Instrument Set
Cooley, Juego de instrumental para recién nacidos
Cooley, boîte à instruments pour des nouveaux-nés
Cooley-Set di strumenti per neonati



Rudolf
COOLEY



komplett
complete
completo
complet
completo

RU 7758-00

Inhalt

- 1 x RU 6059-63 Micro-Ryder Nadelhalter
- 1 x RU 1316-14 Metzenbaum-Fino Schere
- 1 x RU 3328-14 Baby-Mixer Klemme
- 1 x **RU 7530-00 TI** Neonatal Titan Sternumsperrer
- 1 x RU 7754-18 Cooley Atrauma Klemme
- 1 x RU 7754-15 Cooley Atrauma Klemme
- 1 x RU 7754-14 Cooley Atrauma Klemme
- 1 x RU 7754-12 Cooley Atrauma Klemme
- 1 x RU 7754-11 Cooley Atrauma Klemme
- 1 x RU 7754-10 Cooley Atrauma Klemme
- 1 x **RU 7580-10/15 TI** Cooley Titan Pinzette
- 1 x RU 8904-07/01 Etui

Content

- 1 x RU 6059-63 needle holder Micro-Ryder
- 1 x RU 1316-14 scissors Metzenbaum-Fino
- 1 x RU 3328-14 forceps Baby-Mixer
- 1 x **RU 7530-00 TI** sternum spreader for newborns, titanium
- 1 x RU 7754-18 atraumatic clamps Cooley
- 1 x RU 7754-15 atraumatic clamps Cooley
- 1 x RU 7754-14 atraumatic clamps Cooley
- 1 x RU 7754-12 atraumatic clamps Cooley
- 1 x RU 7754-11 atraumatic clamps Cooley
- 1 x RU 7754-10 atraumatic clamps Cooley
- 1 x **RU 7580-10/15 TI** dissecting forceps De Bakey, titanium
- 1 x RU 8904-07/01 case

Contenido

- 1 x RU 6059-63 porta-aguja Micro-Ryder
- 1 x RU 1316-14 tijera Metzenbaum-Fino
- 1 x RU 3328-14 pinza Baby-Mixer
- 1 x **RU 7530-00 TI** separador de esternón para recién nacidos de titanio
- 1 x RU 7754-18 atrauma pinza-clamp Cooley
- 1 x RU 7754-15 atrauma pinza-clamp Cooley
- 1 x RU 7754-14 atrauma pinza-clamp Cooley
- 1 x RU 7754-12 atrauma pinza-clamp Cooley
- 1 x RU 7754-11 atrauma pinza-clamp Cooley
- 1 x RU 7754-10 atrauma pinza-clamp Cooley
- 1 x **RU 7580-10/15 TI** pinza de disección De Bakey, de titanio
- 1 x RU 8904-07/01 estuche

Contenu

- 1 x RU 6059-63 porte-aiguille Micro-Ryder
- 1 x RU 1316-14 ciseaux Metzenbaum-Fino
- 1 x RU 3328-14 pince Baby-Mixer
- 1 x **RU 7530-00 TI** écarteur à sternum néonatal, en titane
- 1 x RU 7754-18 pinces-clamps atraumatiques Cooley
- 1 x RU 7754-15 pinces-clamps atraumatiques Cooley
- 1 x RU 7754-14 pinces-clamps atraumatiques Cooley
- 1 x RU 7754-12 pinces-clamps atraumatiques Cooley
- 1 x RU 7754-11 pinces-clamps atraumatiques Cooley
- 1 x RU 7754-10 pinces-clamps atraumatiques Cooley
- 1 x **RU 7580-10/15 TI** pince à disséquer De Bakey, en titane
- 1 x RU 8904-07/01 boîte

Contenuto

- 1 x RU 6059-63 Portaghi Micro-Ryder
- 1 x RU 1316-14 Forbici Metzenbaum-fino
- 1 x RU 3328-14 Pinze Baby-Mixer
- 1 x **RU 7530-00 TI** Divaricatore per sterno per neonati, titanio
- 1 x RU 7754-18 Pinze cardiovascolari atraumatiche Cooley
- 1 x RU 7754-15 Pinze cardiovascolari atraumatiche Cooley
- 1 x RU 7754-14 Pinze cardiovascolari atraumatiche Cooley
- 1 x RU 7754-12 Pinze cardiovascolari atraumatiche Cooley
- 1 x RU 7754-11 Pinze cardiovascolari atraumatiche Cooley
- 1 x RU 7754-10 Pinze cardiovascolari atraumatiche Cooley
- 1 x **RU 7580-10/15 TI** Pinze cardiovascolare titanio De Bakey
- 1 x RU 8904-07/01 Scatole

TI = TITAN

Neonatal-Klemmen
Neonatal Clamps
Pinzas-clamps para recién nacidos
Pinces-clamps pour des nouveaux-nés
Pinze per neonati

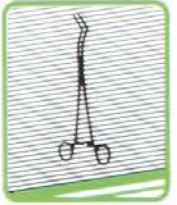

Castaneda

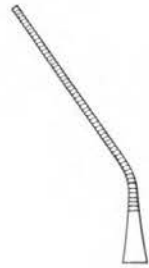

13 cm/5"
RU 7759-01

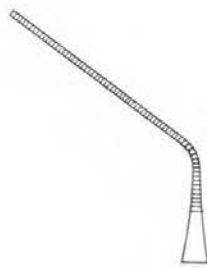

12,5 cm/5"
RU 7759-02

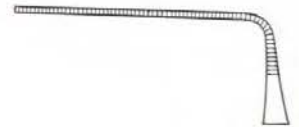

11 cm/4 1/4"
RU 7759-03



15 cm/6"
RU 7759-04



15 cm/6"
RU 7759-05



15 cm/6"
RU 7759-06



15 cm/6"
RU 7759-07

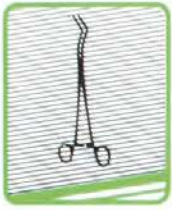

Gefäßklemmen für auswechselbare Mauleinsätze
Vessel Clamps for Interchangeable Jaw Inserts
Pinzas vasculares para bocas intercambiables
Pinces vasculaires pour des mors interchangeables
Pinze vascolari atraumatiche con placche intercambiabili



gerade
straight
rectas
droites
rette

für Einsätze
for inserts
para bocas
pour mors
per morso



abgewinkelt
curved
curvas
courbes
angolate

für Einsätze
for inserts
para bocas
pour mors
per morso



s-gebogen
s-curved
curva en s
courbure en s
s-curve

für Einsätze
for inserts
para bocas
pour mors
per morso

cm/in					
16/6¼			RU 7760-25	33 mm	
17/6¾	RU 7760-20	33 mm			
26/10¼			RU 7760-40	61 mm	RU 7760-45
29/11½	RU 7760-30	61 mm	RU 7760-50	86 mm	61 mm

Einsätze für Gefäßklemmen (lieferbar in Box mit 10 Paar Einsätzen)
 Inserts for vessel clamps (available in boxes with 10 pairs)
 Bocas para pinzas vasculares (disponibles en cajas de 10 pares)
 Mors pour pinces vasculaires (disponibles dans boîtes avec 10 paires)
 Placche di ricambio per pinze vascolari atraumatiche (pacchetto di 10 paia)



33 mm
RU 7760-72



61 mm
RU 7760-74



86 mm
RU 7760-76

Etais für Bulldogklemmen
Cases for Bulldog Clamps
Estuches para clamps Bulldog
Boîtes pour clamps bulldog
Scatole per pinze Bulldog

 **rudolf**
MEDICAL





**Etuis für Bulldogklemmen
Cases for Bulldog Clamps
Estuches para clamps Bulldog
Boîtes pour clamps bulldog
Scatole per pinze Bulldog**

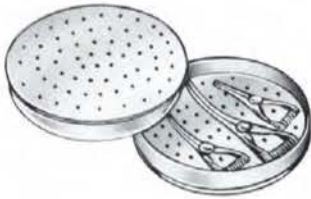

Ø 62 mm
(ohne Bulldogklemmen)
(without bulldog clamps)
(sin clamps Bulldog)
(sans clamps bulldog)
(senza pinze Bulldog)

RU 8916-11



150 x 95 x 13 mm
(ohne Bulldogklemmen, ohne Silikonband)
(without bulldog clamps, without silicone tape)
(sin clamps Bulldog, sin cinta de silicona)
(sans clamps bulldog, sans ruban silicone)
(senza pinze Bulldog, senza banco di silicone)

RU 8917-01

Inhaltsverzeichnis
Index
Indice
Table des matières
Indice



Inhaltsverzeichnis



Acland Mod. , Mikro-Gefäßklemmen.....	37	Baby-Satinsky , Gefäßklemmen.....	111	Atrauma Aorta-Aneurysma-	
Adson , Anatomische Pinzetten.....	43	Bailey , Rippenkontraktoren.....	108	klemmen, Titan.....	122
Anatomische Pinzetten, Titan.....	43	Bailey-Baby , Rippenkontraktoren.....	108	Atrauma Aortaklemmen.....	127
Arterienklemmen.....	26	Bailey-Gibbon , Rippenkontraktoren.....	108	Atrauma Bulldogklemmen.....	116, 117
Atrauma-Pinzetten.....	113	Barraquer , Nadelhalter.....	90	Atrauma Gefäß-	
Chirurgische Pinzetten.....	46	Beck , Atrauma Gefäßklemmen.....	130, 150	klemmen.....	121, 130, 131, 138, 140
Chirurgische Pinzetten, Titan.....	46	Atrauma Gefäßklemmen, Titan.....	130	Atrauma Ligaturklemmen.....	127
Mikro-Grip Pinzetten.....	42	Bengolea , Arterienklemmen.....	27	Atrauma Mehrzweckklemmen.....	133
Wundsperrerr.....	55	Bethune , Rippenscheren.....	97	Atrauma Pinzetten.....	113, 114
Adson-Brown , Chirurgische Pinzetten.....	46	Biemer , Mikro-Gefäßclips.....	39	Atrauma Pinzetten, Titan.....	113, 114
Chirurgische Pinzetten, Titan.....	46	Biemer-Müller , Mikro-Approximatoren.....	39	Atrauma Präparier- und	
Alexander , Raspatorien.....	68	Blake , Embolusfaßzangen.....	63	Ligaturklemmen.....	120
Allis-Atrauma , Gewebe- und Organfaß-		Borowski , Aortenklappenhaken.....	54	Gefäß-Dilatatoren.....	63
zangen.....	92	Bozemann , Nadelhalter.....	83	Gefäßscheren.....	10, 14
Allison , Lungenspatel.....	56	Bridge , Arterienklemmen.....	28	Gefäßscheren, TC.....	14
Alm , Wundsperrerr.....	55	Bronchusklemmen.....	110, 126	Mikro-Grip Nadelhalter.....	8
Anastomosen-		Brunner , Sternumscheren.....	97	Nadelhalter.....	84, 85
klemmen.....	120, 129, 134, 139, 149	Bulldogklemmen.....	35, 115 – 118, 145, 153	Nadelhalter, Titan.....	84
Anatomische Pinzetten.....	43 – 45	Burford , Rippensperrerr.....	107	Neonatal Instrumenten Set.....	143
Anlegepinzetten.....	37 – 39	Böhler , Knochensplitterzangen.....	73	Rippensperrerr.....	103
Anlegezangen.....	115	Castaneda , Neonatal-Klemmen.....	157	Saugkanülen.....	65
Aorta-Anastomosenklemmen.....	130, 135	Rippensperrerr.....	106	De Bakey-Bahnsen , Atrauma Aorta	
Aorta-Aneurysmaklemmen.....	122, 123, 136	Castroviejo , Mikro-Grip Nadelhalter.....	80	Aneurysmenklemmen.....	136
Aorta-Dilatatoren.....	62	Nadelhalter.....	89, 90	De Bakey-Bainbridge , Atrauma	
Aortaklemmen.....	28, 124, 127, 128, 139	Nadelhalter, Titan.....	89	Gefäßklemmen.....	121
Aortenklappenhaken.....	54	Chirurgische Pinzetten.....	46	De Bakey-Beck , Atrauma	
Aortenstanzen.....	62	Chirurgische Scheren.....	2, 3, 8	Gefäßklemmen.....	131
Approximatoren.....	37, 39	Chirurgische Scheren, TC.....	2, 3	De Bakey-Castaneda , Atrauma Herz-	
Arterienklemmen.....	24 – 28	Cleveland , Knochensplitterzangen.....	73	und Gefäßklemmen, Titan.....	141
Atrauma Anastomosen-		Clip-Anlegezangen.....	35, 36	De Bakey-Diethrich , Atrauma-	
klemmen.....	120, 129, 134, 135, 139, 149	Coarctationsklemmen.....	119, 136, 146	Bulldogklemmen.....	115
Aorta-Anastomosenklemmen.....	130, 135	Collin , Rippenscheren.....	96	De Bakey-Diethrich , Atrauma-Pinzetten.....	113
Aorta-Anastomosenklemmen, Titan.....	130	Cone , Wundsperrerr.....	55	De Bakey-Gerald , Atrauma-Pinzetten.....	113
Aorta-Aneurysmaklemmen.....	122, 123, 136	Converse , Nadelhalter.....	85	De Bakey-Pean , Atrauma-	
Aortaklemmen.....	124, 127, 128, 139	Cooley , Aorta Dilatatoren.....	62	Arterienklemmen.....	137
Arterienklemmen.....	137	Atrauma Anastomosenklemmen.....	149	De Bakey-Rankin , Atrauma-	
Aurikelklemmen.....	125	Atrauma Bulldogklemmen.....	145, 153	Mehrzweckklemmen.....	138
Bronchusklemmen.....	126	Atrauma Coarctationsklemmen.....	146	De Bakey-Satinsky , Atrauma-	
Bronchusklemmen, Titan.....	126	Atrauma Coarctationsklemmen, Titan.....	146	Bulldogklemmen.....	116
Bulldogklemmen.....	115 – 118, 145, 153	Atrauma Gefäßklemmen.....	138, 148 – 150	De Bakey-Semb , Atrauma-	
Bulldogklemmen, Titan.....	118	Atrauma Kinderklemmen.....	152	Ligaturklemmen.....	128
Coarctationsklemmen.....	119, 136, 146	Atrauma Ligaturklemmen, Titan.....	151	Deaver , Lungenspatel.....	52
Coarctationsklemmen, Titan.....	146	Atrauma Mehrzweckklemmen.....	147	Deaver , Wundhaken.....	52, 53
Gefäß-		Atrauma Mehrzweckklemmen, Titan.....	147	Derra De Bakey , Atrauma Anastomosen-	
klemmen.....	131, 132, 138, 140, 148 – 151	Atrauma Pinzetten.....	113	klemmen, Titan.....	139
Gefäßklemmen, Titan.....	130, 131	Atrauma Tangentialklemmen.....	151	Desmarres , Gefäß- und Wundhäkchen.....	49
Herz- und Gefäßklemmen.....	141	Atriumhaken.....	54	Dick , Atrauma Anastomosenklemmen.....	134
Herz- und Gefäßklemmen, Titan.....	141	Karotisklemmen.....	144	Diethrich , Arterienklemmen.....	27
Kinderklemmen.....	141 – 143, 152, 154 – 157	Neonatal Instrumenten Set.....	156	Atrauma Aortaklemmen.....	124
Klemmen.....	119 – 157	Rippensperrerr.....	102, 105	Bulldogklemmen.....	35
Ligaturklemmen.....	127, 128, 138, 151	Saugrohre.....	66	Nadelhalter.....	90
Ligaturklemmen, Titan.....	128, 151	Wundhaken.....	54	Doyen , Raspatorien.....	69
Mehrzweckklemmen.....	133, 138, 147	Cooley, Derra , Atrauma Gefäßklemmen.....	151	Drahtscheren.....	76
Mehrzweckklemmen, Titan.....	147	Coryllos , Wundhaken.....	52	Drahtzangen.....	76 – 78
Mikro-Gefäßklemmen.....	142	Crafoord , Arterienklemmen.....	28	Duval , Gewebe- und Organfaßzangen.....	93
Neonatal- und Kinderklemmen.....	154, 155	Arterienklemmen, Titan.....	28	Echlin , Hohlmeißelzangen.....	72
Peripheral-Gefäßklemmen.....	139	Crafoord-Sellers , Aortaklemmen.....	28	Einsätze für Gefäßklemmen.....	158
Pinzetten.....	113, 114	Crawford , Wundhaken.....	51	Embolusfaßzangen.....	63
Pinzetten, Titan.....	113	Crile , Gefäßhäkchen.....	61	Endarterektomie-Scheren, Supercut.....	11
Profundaklemmen.....	139	Crile-Wood , Nadelhalter.....	85	Enderarterektomiestripper.....	59
Profundaklemmen, Titan.....	139	Cushing , Anatomische Pinzetten.....	45	Etuis für Bulldogklemmen.....	160
Präparier- und Ligaturklemmen.....	120	Gefäß- und Wundhäkchen.....	48	Eufrate-Pasque , Nadelhalter.....	87
Subclavia Arterienklemmen.....	131	Gefäßhäkchen.....	61	Favaloro , Gefäßscheren.....	10
Tangentialklemmen.....	129, 151	Cushing-Kocher , Gefäß- und		Feine Scheren.....	9
Tangentialklemmen, Titan.....	129	Wundhäkchen.....	49	Feine Scheren, Supercut.....	9
Atriumhaken.....	54	Dale , Atrauma Peripheral-		Fergusson , Knochenhalte zangen.....	70
Aurikelklemmen.....	125	Gefäßklemmen.....	139	Saugkanülen.....	65
Babcock , Gewebe- und Organfaßzangen.....	92	Hohlmeißelzangen.....	72	Finocchietto , Nadelhalter.....	88
Babcock-Atrauma , Gewebe- und		Dardik , Atrauma Gefäßklemmen.....	132	Rippensperrerr.....	101, 105, 107
Organfaßzangen.....	92	Davidson , Wundhaken.....	54	Finocchietto-Baby , Rippensperrerr.....	100
Baby-Adson , Arterienklemmen.....	26	Davidson-Alexander , Raspatorien.....	68	Finocchietto-Baby-Haight ,	
Baby-Crile-Wood , Nadelhalter.....	85	Davis , Gefäßspatel.....	60	Rippensperrerr.....	107
Baby-Hegemann , Gefäßscheren.....	14	De Bakey , Atrauma Aneurysmaklemmen.....	122	Finocchietto-Burford , Rippensperrerr.....	101
Baby-Mixter , Präparier- und		De Bakey ,		Finocchietto-Mini , Rippensperrerr.....	100
Ligaturklemmen.....	32	Atrauma Aorta-Aneurysmaklemmen.....	122, 123	Frazier , Saugkanülen.....	65

Freer , Gefäßspatel.....	60	Kinder- und Neugeborenen Herz- und Gefäßklemmen.....	141	Lees , Atrauma Bronchusklemmen.....	126
Frykholm , Hohlmeißelzangen.....	72	Kinderklemmen.....	141 – 143, 152, 154 – 157	Atrauma Bronchusklemmen, Titan.....	126
Garrett , Gefäß-Dilatatoren.....	64	Klemmen.....	24 – 39	Leksell , Hohlmeißelzangen.....	72
Gefäßclips.....	36 – 39	Aorta-.....	28	Leland-Jones , Atrauma Klemmen.....	121
Gefäß-Dilatatoren.....	63, 64	Arterien-.....	24 – 28	Lemmon , Nadelhalter.....	87
Gefäßhäkchen.....	61	Atrauma Anasto- mosen-.....	120, 129, 134, 135, 139, 149	Leriche , Arterienklemmen.....	25
Gefäßinstrumente.....	58 – 66	Atrauma Aorta-.....	124, 127, 128, 139	Arterienklemmen, Titan.....	25
Gefäßklemmen mit auswechselbaren Mauleinsätzen.....	158	Atrauma Aorta Anastomosen-.....	130	Lexer , Scheren, Supercut TC.....	5
Gefäßklemmen.....	110, 111	Atrauma Aorta-Aneurysma-.....	122, 123, 136	Scheren, TC.....	5
Gefäßscheren.....	10, 12 – 16, 21	Atrauma Arterien-.....	137	Lichtenberg , Nadelhalter.....	88
Gefäßscheren, TC.....	12 – 14	Atrauma Aurikel-.....	125	Ligaturscheren, TC.....	4
Gefäßscheren, Titan.....	15, 16	Atrauma Bronchus-.....	126	Liston , Knochensplitterzangen.....	73
Gefäßspatel.....	60, 61	Atrauma Bulldog-.....	115 – 118, 145, 153	Liston-Key , Knochensplitterzangen.....	74
Gefäß-Spülkanülen.....	59	Atrauma Coarctations-.....	119, 136, 146	Little , Gefäß- und Wundhäkchen.....	48
Gefäß- und Wundhäkchen.....	48, 49	Atrauma Gefäß-.....	130 – 132, 138, 140, 148 – 151	Love (Morse) , Gefäß- und Wundhäkchen.....	48
Gemini , Präparier- und Ligaturklemmen.....	32	Atrauma Herz- und Gefäß-.....	141	Lovelace , Lungenfaßzangen.....	110
Gerald , Anatomische Pinzetten.....	43	Atrauma Kinder-.....	152	Lungenfaßzangen.....	110
Anatomische Pinzetten, Titan.....	43	Atrauma Ligatur-.....	127, 128, 138, 151	Lungenspatel.....	52 – 54, 56
Chirurgische Pinzetten.....	46	Atrauma Mehrzweck-.....	133, 138, 147	Markwalder , Knochensplitterzangen.....	73
Chirurgische Pinzetten, Titan.....	46	Atrauma Mikro-Gefäß-.....	142	Martin , Wundhaken.....	51
Gewebe- und Organfaßzangen.....	92, 93	Atrauma Neonatal- und Kinder-.....	154, 155	Masson , Nadelhalter.....	87
Giertz-Stille , Rippenscheren.....	96	Atrauma Peripherale Gefäß-.....	139	Mathieu-Kocher , Nadelhalter.....	88
Gil-Vernet , Gefäß- und Wundhäkchen.....	48	Atrauma Profunda-.....	139	Matson , Raspatorien.....	68
Gillies , Chirurgische Pinzetten.....	46	Atrauma Präparier- und Ligatur-.....	120	Mayo , Ligaturscheren.....	4
Chirurgische Pinzetten, Titan.....	46	Atrauma Subclavia Arterien-.....	131	Lungenfaßpinzetten.....	46
Glover , Anastomosen-Klemmen.....	120	Atrauma Tangential-.....	129, 151	Scheren.....	5
Atrauma Anastomosenklemmen.....	129, 135	Atrauma Titan.....	119 – 122, 126, 128 – 131, 139, 141, 142, 146, 147, 151	Scheren, TC.....	5
Glover , Atrauma Bulldogklemmen.....	116, 145	Atrauma Titan Anastomosen-.....	139	Mayo-Hegar , Nadelhalter.....	83, 84
Gluck , Rippenscheren.....	96	Atrauma Titan Aorta-.....	139	Nadelhalter, Titan.....	83
Gregory , Atrauma Profundaklemmen.....	139	Atrauma Titan Bronchus-.....	126	McIndoe , Anatomische Pinzetten.....	43
Gregory-Soft , Atrauma-Bulldogklemmen.....	117	Atrauma Titan Coarctations-.....	146	Anatomische Pinzetten, Titan.....	43
Haight , Rippensperrerr.....	102	Atrauma Titan Gefäß-.....	130, 131	Knochensplitterzangen.....	73
Halle , Gefäßspatel.....	61	Atrauma Titan Herz- und Gefäß-.....	141	Micro-Grip Pinzetten.....	42
Halsey , Nadelhalter.....	85	Atrauma Titan Ligatur-.....	128, 151	Mehrzweckklemmen.....	133, 138, 147
Nadelhalter, Titan.....	85	Atrauma Titan Mehrzweck-.....	147	Mercedes , Thoraxsperrerr.....	104
Halsted-Mosquito , Arterienklemmen.....	25	Atrauma Titan Tangential-.....	129	Metzenbaum , Ligaturscheren.....	4
Arterienklemmen, Titan.....	25	Bulldog-.....	35, 115 – 118, 145, 153	Präparierscheren.....	6 – 8
Harken , Atrauma Aurikelklemmen.....	125	Coarctations-.....	119	Präparierscheren, TC.....	6 – 8
Gefäßklemmen.....	111	Karotis-.....	144	Präparierscheren, TC, Supercut.....	8
Harrington , Präparier- und Ligaturklemmen.....	29	Koronar-Arterien-Präparier-.....	33	Metzenbaum-Fino , Präparierscheren.....	6, 7
Harrington , Wundhaken.....	53	Mikro-Gefäß-.....	37	Präparierscheren, TC.....	6, 7
Harrington-Baby , Wundhaken.....	53	Titan.....	25, 26, 28	Micro-Mosquito , Arterienklemmen.....	26
Harrington-Pemberton , Wundhaken.....	53	Klingenberg-Loth , Gefäßscheren.....	13	Arterienklemmen, Titan.....	26
Hartmann , Arterienklemmen.....	26	Gefäßscheren, TC.....	13	Micro-Ryder , Nadelhalter.....	86
Arterienklemmen, Titan.....	26	Knochen-.....	76	Nadelhalter, Titan.....	86
Harvey , Drahtscheren.....	76	Knochenhaken.....	50	Microvascular , Mikro-Grip Nadelhalter.....	81
Hegar-Vascular , Nadelhalter.....	86	Knochenhalte-.....	70	Nadelhalter.....	86
Hegemann , Gefäßscheren.....	14	Knocheninstrumente.....	68 – 78	Mikro-Doppelspatel.....	59
Heiss , Präparier- und Ligaturklemmen.....	31	Knochensplitterzangen.....	73, 74	Mikro-Gefäßclips.....	38, 39
Henly , Atrauma Subclavia Arterienklemmen.....	131	Kocher , Arterienklemmen.....	24	Mikro-Gefäßklemmen.....	37
Hepp-Scheidel , Nadelhalter.....	90	Wundhaken.....	50	Mikro-Gefäßklemmen für Frühgeborene.....	142
Hohlmeißelzangen.....	71, 72	Kocher-Langenbeck , Wundhaken.....	50	Mikro-Grip Nadelhalter.....	80, 81
Ima , Mikro-Grip-Pinzette.....	42	Kopf- und Seitenschneider.....	78	Mikro-Grip Pinzetten.....	42
Mikro-Grip-Pinzette, Titan.....	42	Koronar-Arterien-Präparierklemmen.....	33	Mikro-Grip Ringpinzetten.....	42
Jacobsen , Gefäßscheren.....	16	Koronar-Scheren.....	10	Mikro-Nadelhalter.....	82, 83
Gefäßscheren, Titan.....	16	Krayenbühl , Gefäßhäkchen.....	61	Mikro-Nadelhalter, Titan.....	83
Jacobson , Mikro-Grip Nadelhalter.....	80	König , Gefäß- und Wundhäkchen.....	49	Mikro-Phlebextraktoren.....	59
Nadelhalter.....	90	Lahey , Gefäß- und Wundhaken.....	49	Mikro-Pinzetten.....	43, 44
Jacobson-Adson , Arterienklemmen.....	27	Lahey (Sweet) , Präparier- und Ligatur klemmen.....	34	Mikroscheren.....	17 – 20
Jacobson-Halsted , Arterienklemmen.....	25	Lambert-Kay , Atrauma Aorta- Anastomosenklemmen.....	130	Mikroscheren, Titan.....	19, 20
Jameson-Werber , Scheren.....	9	Atrauma Aorta-Anastomosenklemmen, Titan.....	130	Mikulicz , Wundhaken.....	51
Javid , Karotisklemmen.....	144	Lambotte , Raspatorien.....	68	Millesi , Mikroscheren.....	18
Jorgensen , Gefäßscheren.....	13	Langenbeck , Knochenhalte-.....	70	Mills , Gefäßscheren.....	21
Joseph , Scheren.....	9	Raspatorien.....	68	Mini-Gemini , Präparier- und Ligaturklemmen.....	32
Kader , Wundhaken.....	53	Langenbeck , Wundhaken.....	50	Mini-Phlebextraktoren.....	59
Kalt , Nadelhalter.....	89	Langenbeck-Ryder , Nadelhalter.....	88	Mixer , Präparier- und Ligaturklemmen.....	33
Kantrowitz , Präparier- und Ligaturklemmen.....	29	Lawrence , Präparier- und Ligaturklemmen.....	34	Mixer O'Shaughnessy , Präparier- und Ligaturklemmen.....	33
Karotisklemmen.....	144	Lazar , Mikro-Pinzetten.....	45	Morris-De Bakey , Atrauma Aorta- Anastomosenklemmen.....	135
Kelly , Scheren.....	8	Lebsche , Sternmeißel.....	97	Morse , Rippensperrerr.....	106
Wundhaken.....	51			Morse-Favaloro , Rippensperrerr.....	104, 106

Inhaltsverzeichnis



Müller , Approximatoren.....	39	Saugkanülen.....	65	Venenstripper-Besteck	58
Gefäßclips.....	38	Saugrohre.....	66	Venenstripper	58
Nabatoff , Venenstripper-Besteck	58	Sawtell , Präparier- und Ligaturklemmen.....	33	Volkmann , Wundhaken.....	50
Nadelhalter	80 – 90	Scheren	2 – 21	Wangenstein , Anatomische Pinzetten.....	45
Nelson , Faßpinzetten.....	46	Chirurgische.....	2, 3, 8	Nadelhalter	87
Neonatal Instrumenten Set	143, 156	Chirurgische-, TC.....	2, 3	Weber , Atrauma Aortaklemmen.....	128
Neonatal-Klemmen	157	Endarterektomie-, Supercut.....	11	Weitlaner , Wundsperrer.....	55, 56
Neonatal Sternumsperrer, Titan	108	Feine.....	9	Wertheim , Atrauma Anastomosens-	
Ochsner , Atrauma Aortaklemmen	124	Feine-, Supercut	9	klemmen.....	134
Ochsner-Kocher , Arterienklemmen	24	Gefäß.....	10, 12– 16, 21	Wickstroem , Präparier- und	
Overholt , Präparier- und Ligaturklemmen..	30	Gefäß-, Titan.....	15, 16	Ligaturklemmen	34
Overholt-Geissendörfer , Präparier- und		Koronar.....	10	Williams , Gewebe- und Organfaßzangen...	92
Ligaturklemmen.....	31	Ligatur-, TC.....	4	Wundhaken.....	48 – 54
Overholt-Mixer , Präparier- und Ligatur-		Mikro.....	17 – 20	Wundsperrer.....	55, 56
klemmen.....	31	Mikro-, Titan	19, 20	Wylie , Atrauma Gefäßklemmen	123
Overholt-Slim , Präparier- und Ligatur		Präparier.....	5 – 8	Yankauer , Saugkanülen.....	65
klemmen.....	30	Präparier-, Supercut TC.....	5, 8	Zenker , Wundhaken.....	53
Pean , Arterienklemmen.....	24	Präparier-, TC	5	Zweifel , Nadelhalter	88
Peripheral-Gefäßklemmen.....	139	Supercut.....	11		
Phlebodissektoren	59	Titan.....	15, 16, 19, 20		
Phleboextraktoren	59	Venen-	18		
Phlebotomie-Haken	60	Schmid , Gefäß-Spülkanülen.....	59		
Pinzetten	42 – 46	Gefäßspatel	60		
Anatomische.....	43, 45	Schwartz , Clip-Anlegezangen	35		
Anlege.....	37 – 39	Seitenschneider.....	78		
Atrauma.....	113, 114	Sellors , Rippenkontraktoren	108		
Chirurgische.....	46	Semb , Hohlmeißelzangen.....	71		
Faß.....	45	Knochenhaltezangen.....	70		
Lungenfaß.....	46	Knochensplitterzangen	74		
Mikro.....	43, 44	Präparier- und Ligaturklemmen	110		
Mikro-Grip.....	42	Raspatorien	69		
Mikro-Knüpfer.....	45	Sicherungsschloß.....	119		
Ring.....	42	Silikonband	160		
Titan.....	43, 44, 46	Simon , Wundhaken	51		
Tumorfäß.....	44	Singley-Tuttle , Faßpinzetten	46		
Potts , Atrauma Coarctations-Klemmen.....	119	Spülkanülen.....	59		
Atrauma-Klemmen.....	119	Standard , Scheren.....	2, 3		
Coarctations-Klemmen	119	Sterilisierbehälter.....	64		
Potts-De Martel , Gefäßscheren	21	Sternumscheren	96		
Potts-Smith , Anatomische Pinzetten.....	45	Stille , Hohlmeißelzangen	72		
Gefäßscheren	10, 12, 13	Rippenscheren.....	96		
Gefäßscheren, Supercut.....	11	Stille-Liston , Knochensplitterzangen	74		
Gefäßscheren, TC	12	Stille-Luer , Hohlmeißelzangen	71		
Price-Thomas , Bronchusklemmen	110	Stille-Ruskin , Hohlmeißelzangen.....	71		
Profundaklemmen	139	Struck , Rippensperrer.....	100		
Präparier- und Ligatur-		Strully , Gefäßscheren.....	21		
klemmen	26, 27, 29 – 34, 110, 120	Subclavia Arterienklemmen.....	131		
Präparierscheren	5 – 8	Subramanian-Miniature , Atrauma			
Raspatorien	68, 69	Aortaklemmen	139		
Reynolds , Scheren	9	Atrauma Aortaklemmen, Titan	139		
Scheren, Supercut.....	9	Tangentialklemmen.....	129, 151		
Rienhoff-Finocchietto , Rippensperrer.....	102	Thoraxsperrer	104		
Ringpinzetten.....	42	Titan Atrauma-Bulldogklemmen	118		
Rippenkontraktoren	108	Titan Atrauma.....	119 – 122, 126, 128 – 131,		
Rippenscheren	96, 97	Klemmen.....	139, 141, 142, 146, 147, 151		
Rippensperrer.....	100 – 108	Titan Klemmen	25, 26, 28		
Rochester-Pean , Arterienklemmen	24	Titan Nadelhalter	83 – 86, 89		
Ross , Wundhaken.....	54	Titan Neonatal Sternumsperrer	108		
Rudolf , Nadelhalter.....	86	Titan Pinzetten.....	43, 44, 46		
Rumel , Präparier- und Ligaturklemmen	29	Titan Scheren	15, 16, 19, 20		
Rumel-Belmont , Tourniquets	66	Toennis , Gefäßspatel	60		
Ruskin-Liston , Knochensplitterzangen	74	Tönnis , Nadelhalter	88		
Ryder , Mikro-Grip Nadelhalter	81	Tönnis-Adson , Gefäßscheren, TC	13		
Nadelhalter	86	Tourniquets.....	66		
Santulli , Atrauma-Bulldogklemmen	117	Tubbs , Aorta Dilatatoren.....	62		
Atrauma-Bulldogklemmen, Titan.....	117	Tumorfäßpinzetten	44		
Sarot , Arterienklemmen	28	Universal , Drahtscheren	76		
Nadelhalter	87	Varady , Mikro-Doppelspatel.....	59		
Satinsky , Gefäßklemmen	111	Varady , Mikro-Phlebextraktoren.....	59		
Gefäßscheren.....	13	Mini-Phlebextraktoren	59		
Satinsky/DeBailey , Atrauma		Phlebodissektoren	59		
Tangentialklemmen.....	129	Varady , Phleboextraktoren.....	59		
Sauerbruch , Hohlmeißelzangen.....	72	Varizeninstrumente.....	59		
Sauerbruch , Rippenscheren.....	96	Varizeninstrumente.....	59		
Wundhaken.....	52	Venenscheren.....	18		

Index

- Acland Mod.**, micro vascular forceps 37
- Adson**, atraumatic dressing forceps 113
 dressing forceps, titanium 43
 dressing forceps 43
 hemostatic forceps 26
 micro-grip forceps 42
 retractors 55
 tissue forceps, titanium 46
 tissue forceps 46
- Adson-Brown**, tissue forceps, titanium 46
 tissue forceps 46
- Alexander**, periosteal raspatories 68
- Allis-Atrauma**, tissue and organ grasping forceps 92
- Allison**, lung spatulas 56
- Alm**, retractors 55
- Anastomosis clamps** 120, 129, 134, 139, 149
- Aorta valve retractors** 54
- Aortic anastomosis clamps** 130, 135
 aneurysm clamps 122, 123, 136
 clamps 28, 124, 127, 128, 139
 dilators 62
 punches 62
- Applying forceps** 37 – 39
- Approximators** 37, 39
- Atraumatic anastomosis clamps** 120, 129, 134, 135, 139, 149
- aortic anastomosis clamps** 130, 135
 titanium 130
- aortic aneurysm clamps** 122, 123, 136
- aortic clamps** 124, 127, 128, 139
- auricle clamps** 125
- bronchus clamps, titanium** 126
- bronchus clamps** 126
- bulldog clamps, titanium** 118
- bulldog clamps** 115 – 118, 145, 153
- cardiovascular clamps** 141
- cardiovascular clamps, titanium** 141
- cardiovascular forceps** 130 – 132, 138, 140, 148 – 151
- clamps for children** 141 – 143, 152, 154 – 157
- clamps** 119 – 157
- coarctation clamps, titanium** 146
- coarctation clamps** 119, 136, 146
- dissecting and ligature clamps** 120
- dressing forceps, titanium** 113
- dressing forceps** 113, 114
- hemostatic forceps** 137
- ligature clamps, titanium** 151
- ligature clamps** 127, 128, 138, 151
- micro vascular clamps** 142
- multi purpose clamps, titanium** 147
- multi purpose clamps** 133, 138, 147
- pediatric clamps** 154, 155
- peripheral clamps** 139
- profunda clamps, titanium** 139
- profunda clamps** 139
- subclavian artery clamps** 131
- tangential occlusion clamps** 129, 151
- titanium cardiovascular forceps** 131
- titanium ligature clamps** 128
- titanium tangential occlusion clamps** 129
- Atrium retractors** 54
- Auricle clamps** 125
- Babcock**, tissue and organ grasping forceps 92
- Babcock-Atrauma**, tissue and organ grasping forceps 92
- Baby-Adson**, hemostatic forceps 26
- Baby-Crile-Wood**, needle holders 85
- Baby-Hegemann**, cardiovascular scissors 14
- Baby-Mixter**, dissecting and ligature
- Baby-Mixer**, clamps 32
- Baby-Satinsky**, cardiovascular clamps 111
- Bailey**, rib contractors 108
- Bailey-Baby**, rib contractors 108
- Bailey-Gibbon**, rib contractors 108
- Barraquer**, needle holders 90
- Beck**, atraumatic cardiovascular clamps, titanium 130
- Beck**, atraumatic cardiovascular clamps 130, 150
- Bengolea**, hemostatic forceps 27
- Bethune**, rib shears 97
- Biemer**, micro vessel clips 39
- Biemer-Müller**, micro approximators 39
- Blake**, embolus grasping forceps 63
- Bone cutting forceps** 73, 74
 holding forceps 70
 hooks 50
 instruments 68 – 78
 rongeurs 71, 72
 wire 76
- Borowski**, aorta valve retractors 54
- Bozemann**, needle holders 83
- Bridge**, hemostatic forceps 28
- Bronchus clamps** 110, 126
- Brunner**, sternum scissors 97
- Bulldog clamps** 35, 115 – 118, 145, 153
- Burford**, rib spreaders 107
- Böhler**, bone cutting forceps 73
- Cardiovascular clamps for children and newborn** 141
- Carotid clamps** 144
- Cases for bulldog clamps** 160
- Castaneda**, neonatal clamps 157
 rib spreader 106
- Castroviejo**, micro-grip needle holders 80
 needle holders, titanium 89
 needle holders 89, 90
- Clamps**
 aorta 28
 atraumatic anastomosis, titanium 139
 atraumatic aorta anastomosis 130
 atraumatic aorta anastomosis, titanium 130
 atraumatic aorta aneurysm 122, 123, 136
 atraumatic aorta, titanium 124, 127, 128, 139
 atraumatic aorta, titanium 139
 atraumatic auricle 125
 atraumatic bronchus, titanium 126
 atraumatic bronchus 126
 atraumatic bulldog 115 – 118, 145, 153
 atraumatic cardiovascular 141
 atraumatic cardiovascular, titanium 141
 atraumatic coarctation, titanium 146
 atraumatic dissecting and ligature 120
 atraumatic ligature, titanium 128, 151
 atraumatic ligature 127, 128, 138, 151
 atraumatic micro-vascular 142
 atraumatic multi purpose 133, 138, 147
 atraumatic multi purpose, titanium 147
 atraumatic neonatal and children clamps 154, 155
 atraumatic pediatric 152
 atraumatic peripheral 139
 atraumatic profunda 139
 atraumatic subclavia artery 131
 atraumatic tangential occlusion, titanium 129
 atraumatic, titanium 119 – 122, 126, 128 – 131, 139, 141, 142, 146, 147, 151
 atraumatic vascular, titanium 130, 131
 atraumatic vascular 130 – 132, 138, 140, 148 – 151
 bulldog 35, 115 – 118, 145, 153
 carotid 144
- Clamps, coarctation** 119
 coronary artery dissecting 33
 micro vascular 37
- Cleveland**, bone cutting forceps 73
- Clip applying forceps** 35 – 36
- Coarctation clamps** 119, 136, 146
- Colling**, rib shears 96
- Cone**, retractors 55
- Converse**, needle holders 85
- Cooley**, aortic dilators 62
 aspiration tubes 66
 atraumatic anastomosis clamps 149
 atraumatic bulldog clamps 145, 153
 atraumatic cardiovascular clamps 138, 148 – 150
 atraumatic coarctation clamps 146
 atraumatic coarctation clamps, titanium 146
 atraumatic dressing forceps 113
 atraumatic ligature clamps, titanium 151
 atraumatic multi purpose clamps 147
 atraumatic multi purpose clamps, titanium 147
 atraumatic pediatric clamps 152
 atraumatic tangential occlusion clamps 151
 atrium retractor 54
 carotid clamps 144
 neonatal instrument set 156
 retractors 54
 rib spreader 102, 105
- Cooley-Derra**, atraumatic cardiovascular clamps 151
- Coronary artery dissecting clamps** 33
 scissors 10
- Coryllos**, retractors 52
- Crafoord**, hemostatic forceps, titanium 28
 hemostatic forceps 28
- Crafoord-Sellers**, aortic clamps 28
- Crawford**, retractors 51
- Crile**, vessel hooks 61
- Crile-Wood**, needle holders 85
- Cushing**, dressing forceps 45
 vessel and wound retractors 48
 vessel hooks 61
- Cushing-Kocher**, vessel and wound retractors 49
- Dale**, atraumatic peripheral vascular clamps 139
 bone rongeur forceps 72
- Dardik**, atraumatic cardiovascular clamps 132
- Davidson**, retractors 54
- Davidson-Alexander**, raspatories 68
- Davis**, vessel spatulas 60
- De Bakey**, atraumatic aneurysm clamps 122
 atraumatic aortic aneurysm clamps 122, 123
 atraumatic aortic aneurysm clamps, titanium 122
 atraumatic aortic clamps 127
 atraumatic bulldog clamps 116, 117
 atraumatic cardiovascular clamps 121, 130, 131, 138, 140
 atraumatic dissecting and ligature clamps 120
 atraumatic dressing forceps, titanium 113, 114
 atraumatic dressing forceps 113, 114
 atraumatic ligature clamps 127
 atraumatic multi purpose clamps 133
 micro-grip needle holders 81
 needle holders, titanium 84
 needle holders 84, 85
 neonatal instrument set 143
 rib spreaders 103
- De Bakey**, suction tubes 65
 vascular scissors, TC 14

Index



vascular scissors	10, 14	Freer , vessel spatulas	60	periosteal raspatories	68
vessel dilators	63	Frykholm , bone rongeur forceps	72	retractors	50
De Bakey-Bahnson , atraumatic aortic		Garrett , vessel dilators	64	Langenbeck-Ryder , needle holders	88
aneurysm clamps	136	Gemini , dissecting and ligature clamps	32	Lateral and frontal cutting pliers	78
De Bakey-Bainbridge , atraumatic cardio-		Gerald , dressing forceps	43	Lawrence , dissecting and ligature forceps	34
vascular clamps	121	dressing scissors, titanium	43	Lazar , micro dressing forceps	45
De Bakey-Beck , atraumatic cardio-		tissue forceps, titanium	46	Lebsche , sternum chisels	97
vascular clamps	131	tissue forceps	46	Lees , atraumatic bronchus forceps	126
De Bakey-Castaneda , atraumatic cardio-		Giertz-Stille , rib shears	96	atraumatic bronchus forceps, titanium	126
vascular clamps, titanium	141	Gil-Vernet , vessel and wound hooks	48	Leksell , bone rongeur forceps	72
De Bakey-Diethrich , atraumatic bulldog		Gillies , tissue forceps, titanium	46	Leland-Jones , atraumatic clamps	121
clamps	115	tissue forceps	46	Lemmon , needle holders	87
atraumatic dressing forceps	113	Glover , anastomosis clamps	120	Lerliche , hemostatic forceps, titanium	25
De Bakey-Gerald , atraumatic dressing		atraumatic anastomosis clamps	129, 135	hemostatic forceps	25
forceps	113	atraumatic bulldog clamps	116, 145	Lexer , scissors, Supercut TC	5
De Bakey-Pean , atraumatic hemostatic		Gluck , rib shears	96	scissors, TC	5
forceps	137	Grasping forceps	45	Lichtenberg , needle holders	88
De Bakey-Rankin , atraumatic multi		Gregory , atraumatic profunda clamps	139	Ligature scissors, TC	4
purpose forceps	138	Gregory-Soft , atraumatic bulldog clamps	117	Liston , bone cutting forceps	73
De Bakey-Satinsky , atraumatic bulldog		Haight , rib spreaders	102	Liston-Key , bone cutting forceps	74
clamps	116	Halle , vessel spatulas	61	Little , vessel and wound hooks	48
De Bakey-Semb , atraumatic ligature		Halsey , needle holders, titanium	85	Love (Morse) , vessel and wound hooks	48
clamps	128	needle holders	85	Lovelace , lung grasping forceps	110
Deaver , lung spatulas	52	Halsted-Mosquito , hemostatic forceps,		Lung grasping forceps	46, 110
retractors	52, 53	titanium	25	spatulas	52 – 54, 56
Derra-De Bakey , atraumatic anastomosis		Harken , auricle clamps	125	Markwalder , bone cutting forceps	73
clamps, titanium	139	blood vessel clamps	111	Martin , retractors	51
Desmarres , vessel and wound		Harrington , dissecting and ligature		Masson , needle holders	87
retractors	49	forceps	29	Mathieu-Kocher , needle holders	88
Dick , atraumatic anastomosis clamps	134	retractors	53	Matson , periosteal raspatories	68
Diethrich , atraumatic aortic clamps	124	Harrington-Baby , retractors	53	Mayo , ligature scissors	4
bulldog clamps	35	Harrington-Pemberton , retractors	53	lung grasping forceps	46
hemostatic forceps	27	Hartmann , hemostatic forceps, titanium	26	scissors, TC	5
needle holders	90	hemostatic forceps	26	scissors	5
Dissecting and ligature clamps	26, 27,	Harvey , wire scissors	76	Mayo-Hegar , needle holders, titanium	83, 84
29 – 34, 110, 120		Hegar-Vascular , needle holders	86	needle holders	83
Dissecting scissors	5 – 8	Hegemann , vascular scissors	14	Mc Indoe , bone cutting forceps	73
Doyen , periosteal raspatories	69	Heiss , dissecting and ligature forceps	31	dressing forceps, titanium	43
Dressing and tissue forceps	42 – 46	Hemostatic forceps	24 – 28	dressing forceps	43
Dressing forceps, titanium	25, 26, 28	Henly , subclavian artery clamps	131	micro-grip forceps	42
Dressing forceps	43 – 45	Hepp-Scheidt , needle holders	90	Mercedes , thoracic spreaders	104
Duval , tissue and organ grasping		Inserts for vessel clamps	158	Metzenbaum , dissecting scissors, TC	6 – 8
forceps	93	Irrigation cannulas	59	dissecting scissors, TC, Supercut	8
Echlin , bone rongeur forceps	72	Ima , micro-grip forceps	42	dissecting scissors	6 – 8
Embolus grasping forceps	63	micro-grip forceps, titanium	42	ligature scissors	4
Endarterectomy scissors, Supercut	11	Jacobson , vascular scissors, titanium	16	Metzenbaum-Fino , dissecting scissors	6, 7
strippers	59	vascular scissors	16	dissecting scissors, TC	6, 7
Eufrate-Pasque , needle holders	87	micro-grip needle holders	80	Micro dressing forceps	43, 44
Favaloro , vascular scissors	10	needle holders	90	Micro forceps	43, 44
Fergusson , bone holding forceps	70	Jacobson-Adson , hemostatic forceps	27	needle holders, titanium	83
suction tubes	65	Jacobson-Halsted , hemostatic forceps	25	needle holders	82, 83
Fine scissors, Supercut	9	Jameson-Werber , scissors	9	phlebextractors	59
Fine scissors	9	Javid , carotid clamps	144	scissors, titanium	19, 20
Finocchietto , needle holders	88	Jorgensen , vascular scissors	13	scissors	17 – 20
rib spreaders	101, 105, 107	Joseph , scissors	9	spatulas	59
Finocchietto-Baby , rib spreaders	100	Kader , retractors	53	suture tying forceps	45
Finocchietto-Baby-Haight , rib spreaders	107	Kalt , needle holders	89	vascular clamps for prematures	142
Finocchietto-Burford , rib spreaders	101	Kantrowitz , dissecting and ligature forceps	29	vessel clamps	37
Finocchietto-Mini , rib spreaders	100	Kelly , retractors	51	vessel clips	38, 39
Forceps, applying	37 – 39	scissors	8	Micro-Mosquito , hemostatic forceps	26
atraumatic dressing	113, 114	Klingenberg-Loth , vascular scissors TC	13	hemostatic forceps, titanium	26
atraumatic hemostatic	137	vascular scissors	13	Micro-Ryder , needle holders, titanium	86
dressing	43, 45	Kocher , hemostatic forceps	24	needle holders	86
grasping	45	retractors	50	Micro-grip dressing forceps	42
hemostatic	24 – 28	Kocher-Langenbeck , retractors	50	forceps	42
lung grasping	46	Krayenbühl , vessel hooks	61	needle holders	80, 81
micro suture tying	45	König , vessel and wound hooks	49	ring forceps	42
micro-grip	42	Lahey (Sweet) , dissecting and ligature		Microvascular , micro-grip needle holders	81
micro	43, 44	forceps	34	Microvascular , needle holders	86
ring	42	Lambert-Kay , atraumatic aorta anastomosis		Mikulicz , retractors	51
Forceps, tissue	46	clamps, titanium	130	Millesi , micro scissors	18
titanium	43, 44, 46	Lambert-Kay , atraumatic aorta		Mills , vascular scissors	21
tumor grasping	44	anastomosis clamps	130	Mini-Gemini , dissecting and ligature	
Forceps	24 – 39	Lambotte , periosteal raspatories	68	forceps	32
Frazier , suction tubes	65	Langenbeck , bone holding forceps	70	Mini-phlebextractors	59

Mixer O'Shaugnessy , dissecting and ligature forceps	33	vessel suction cannulas	59	stripper set	58
Mixer , dissecting and ligature forceps	33	Schwartz , clip applying forceps	35	strippers	58
Morris-De Bakey , atraumatic aorta anastomosis clamps	135	Scissors, Supercut	11	Vessel and wound retractors	48, 49
Morse , rib spreaders	106	coronary	10	clamps with interchangeable jaw inserts	158
Morse-Favaloro , rib spreaders	104, 106	dissecting, Supercut TC	5	clamps	110, 111
Mosquito , atrauma hemostatic forceps	137	dissecting, TC	5, 8	clips	36 – 39
Multi purpose clamps	133, 138, 147	dissecting	5 – 8	dilators	63, 64
Myers , vein strippers	58	endarterectomy, Supercut	11	hooks	61
Müller , approximators	39	fine, Supercut	9	instruments	58 – 66
vessel clips	38	fine	9	spatulas	60, 61
Nabatoff , vein stripper set	58	ligature, TC	4	suction tubes	59
Needle holders	80 – 90	micro, titanium	19, 20	Volkmann , retractors	50
Nelson , grasping forceps	46	micro	17 – 20	Wangensteen , dressing forceps	45
Neonatal clamps	157	operating TC	2, 3	needle holders	87
instrument set	143, 156	operating	2, 3, 8	Weber , atraumatic aorta clamps	128
rib spreaders, titanium	108	titanium	15, 16, 19, 20	Weitlaner , retractors	55, 56
Ochsner , atraumatic aorta clamps	124	vascular, titanium	15, 16	Wertheim , atrauma anastomosis clamps	134
Ochsner-Kocher , hemostatic forceps	24	vascular	10, 12 – 16, 21	Wickstroem , dissecting and ligature forceps	34
Operating scissors, TC	2, 3	vein	18	Williams , tissue and organ grasping forceps	92
scissors	2, 3, 8	Scissors	2 – 21	Wire cutting pliers	76 – 78
Overholt , dissecting and ligature forceps	30	Self-retaining retractors	55, 56	scissors	76
Overholt-Geissendörfer , dissecting and ligature forceps	31	Sellers , rib contractors	108	Wylie , atraumatic vessel clamps	123
Overholt-Mixer , dissecting and ligature forceps	31	Semb , bone cutting forceps	74	Yankauer , suction tubes	65
Overholt-Slim , dissecting and ligature forceps	30	bone holding forceps	70	Zenker , retractors	53
Pean , hemostatic forceps	24	bone rongeur forceps	71	Zweifel , needle holders	88
Pediatric clamps	141 – 143, 152, 154 – 157	dissecting and ligature forceps	110		
Periosteal raspatories	68, 69	periosteal raspatories	69		
vascular clamps	139	Setting forceps	115		
Phlebodissectors	59	Silicone tapes for metal cases	160		
Phleboextractors	59	Simon , retractors	51		
Phlebectomy Hooks	60	Singley-Tuttle , grasping forceps	46		
Potts , atraumatic clamps	119	Sterilizing cases	64		
atraumatic coarctation clamps	119	Sternum scissors	96		
coarctation clamps	119	Stille , bone rongeur forceps	72		
Potts-De Martel , vascular scissors	21	rib scissors	96		
Potts-Smith , dressing forceps	45	Stille-Liston , bone cutting forceps	74		
vascular scissors, Supercut	11	Stille-Luer , bone rongeur forceps	71		
vascular scissors, TC	12	Stille-Ruskin , bone rongeur forceps	71		
vascular scissors	10, 12, 13	Struck , rib spreaders	100		
Price-Thomas , bronchus forceps	110	Strully , vascular scissors	21		
Profunda clamps	139	Subclavia , hemostatic forceps	131		
Ratchet lock	119	Subramanian-Miniature , atraumatic aorta clamps	139		
Retractors	48 – 54	atraumatic clamps, titanium	139		
Reynolds , scissors, Supercut	9	Suction cannulas	65		
scissors	9	tubes	66		
Rib contractors	108	Tangential occlusion clamps	129, 151		
Rib scissors	96, 97	Thoracic spreaders	104		
Rib spreaders	100 – 108	Tissue and organ grasping forceps	92, 93		
Rienhoff-Finocchietto , rib spreaders	102	Tissue forceps	46		
Ring forceps	42	Titanium atraumatic bulldog clamps	118		
Rochester-Pean , hemostatic forceps	24	atraumatic clamps	119 – 122, 126, 128 – 131, 139, 141, 142, 146, 147, 151		
Ross , retractors	54	clamps	25, 26, 28		
Rudolf , needle holders	86	dressing forceps	43, 44, 46		
Rumel , dissecting and ligature forceps	29	needle holders	83 – 86, 89		
Rumel-Belmont , tourniquets	66	rib spreaders	108		
Ruskin-Liston , bone cutting forceps	74	scissors	15, 16, 19, 20		
Ryder , micro-grip needle holders	81	Toennis , vessel spatulas	60		
needle holders	86	Tourniquets	66		
Santulli , atraumatic bulldog clamps	117	Tubbs , aorta dilators	62		
Sarot , hemostatic forceps	28	Tumor grasping forceps	44		
needle holders	87	Tönnis , needle holders	88		
Satinsky , vessel clamps	111	Tönnis-Adson , vascular scissors, TC	13		
vessel scissors	13	Universal , wire scissors	76		
Satinsky/De Bakey , atraumatic tangential occlusion clamps	129	Varady , micro phleboextractors	59		
Sauerbruch , bone rongeur forceps	72	micro spatula	59		
retractors	52	Varady , mini phleboextractors	59		
rib scissors	96	phlebodissectors	59		
Sawtell , dissecting and ligature forceps	33	phleboextractors	59		
Schmid , vessel spatulas	60	Varix instruments	59		
		Vascular scissors, TC	12 – 14		
		Vascular scissors, titanium	15, 16		
		scissors	10, 12 – 16, 21		
		Vein scissors	18		

Indice



Acland Mod. , micro-pinzas vasculares	37	periféricas	139	dilatadores de aorta	62
Adson , pinzas „Micro-Grip“	42	pinzas-clamps	119 – 157	juego de instrumental para recién nacidos	156
pinzas de disección atrauma	113	Babcock , pinzas para coger tejidos y órganos	93	pinzas-clamps para carotis	144
pinzas de disección con dientes	46	Babcock-Atrauma , pinzas para coger tejidos y órganos	93	separadores	54
pinzas de disección con dientes de titanio	46	Baby-Adson , pinzas hemostáticas	26	separadores costales	102, 105
pinzas de disección sin dientes	43	Baby-Crile-Wood , porta-agujas	85	separadores para aurícula	54
pinzas de disección sin dientes de titanio	43	Baby-Hegemann , tijeras vasculares	14	Cooley-Derra , atrauma pinzas-clamps vasculares	151
pinzas hemostáticas	26	Baby-Mixer , pinzas para preparaciones y ligaduras	32	Coronarias, pinzas-clamps para arterias	33
separadores	55	Baby-Satinsky , pinzas-clamps vasculares	111	tijeras	10
Adson-Brown , pinzas de disección con dientes	46	Bailey , aproximadores para costillas	108	Coryllos , separadores	52
pinzas de disección con dientes de titanio	46	Bailey-Baby , aproximadores para costillas	108	Costótomos	96, 97
Alexander , periostótomos	68	Bailey-Gibbon , aproximadores para costillas	108	Crafoord , pinzas hemostáticas	28
Alicates para alambre con corte lateral	78	Barraquer , porta-agujas	90	pinzas hemostáticas de titanio	28
Alicates para alambre con corte lateral y frontal	78	Beck , atrauma pinzas-clamps vasculares	130, 150	Crafoord-Sellers , pinzas para aorta	28
Alicates para cortar alambre	76 – 78	Beck , atrauma pinzas-clamps vasculares de titanio	130	Crawford , separadores	51
Allis-Atrauma , pinzas para coger tejidos y órganos	93	Bengolea , pinzas hemostáticas	27	Crile , ganchitos vasculares	61
Allison , espátulas pulmonares	56	Bethune , costótomos	97	Crile-Wood , porta-agujas	85
Alm , separadores	55	Bierner , micro-clips vasculares	39	Cushing , ganchitos vasculares	61
Anillos, pinzas de disección con	42	Biemer-Müller , micro-aproximadores	39	ganchos vasculares	48
Aorta, pinzas para	28	Blake , pinzas para coger émbolos	63	pinzas de disección sin dientes	45
Aplicar clips, pinzas para	37 – 39	Bocas para pinzas-clamps vasculares	158	Cushing-Kocher , ganchos vasculares	49
Aproximadores para costillas	108	Borowski , ganchos para aorta	54	Cánulas de aspiración	65
Aproximadores	37, 39	Bozemann , porta-agujas	83	de irrigación	59
Atrauma clamps Bulldog, 115 – 118, 145, 153 clamps Bulldog de titanio	118	Bridge , pinzas hemostáticas	28	de irrigación para vasos	59
micro-pinzas-clamps vasculares	142	Brunner , tijeras de esternón	97	Dale , atrauma pinzas-clamps vasculares periféricos	139
pinzas de disección	113, 114	Burford , separadores costales	107	Dale , pinzas-gubias	72
pinzas de disección de titanio	113	Böhler , pinzas cortantes para huesos	73	Dardik , atrauma pinzas-clamps vasculares	132
pinzas hemostáticas	137	Carotis, pinzas-clamps para	144	Davidson , separadores	54
pinzas para subclavia	131	Castaneda , pinzas-clamps para recién nacidos	157	Davidson-Alexander , periostótomos	68
pinzas-clamps auriculares	125	separadores costales	106	Davis , espátulas vasculares	60
pinzas-clamps bronquiales	126	Castroviejo , porta-agujas	89, 90	De Bakey , atrauma clamps Bulldog, 116, 117 atrauma pinzas de disección	113, 114
pinzas-clamps bronquiales de titanio	126	porta-agujas „Micro-Grip“	80	atrauma pinzas de disección de titanio	113, 114
pinzas-clamps cardiovasculares	141	porta-agujas de titanio	89	atrauma pinzas hemostáticas	137
pinzas-clamps cardiovasculares de titanio	141	Cierre de seguridad	119	atrauma pinzas-clamps para aneurisma	122
pinzas-clamps para anastomosis	120, 129, 134, 135, 139, 149	Cintas de silicona	160	atrauma pinzas-clamps para aneurisma de aorta	122, 123
pinzas-clamps para anastomosis de aorta	130, 135	Cizallas para cortar alambre	76	atrauma pinzas-clamps para aneurisma de aorta de titanio	122
pinzas-clamps para anastomosis de titanio	130	Clamps Bulldog	36, 115 – 118, 145, 153	atrauma pinzas-clamps para aorta	127
pinzas-clamps para aneurisma de aorta	122, 123, 136	Bulldog, atrauma	115 – 118, 145, 153	atrauma pinzas-clamps	121, 130, 131, 138, 140
pinzas-clamps para aorta	124, 127, 128, 139	vasculares, micro	37	atrauma pinzas-clamps para ligadura	127
pinzas-clamps para coarctación	119, 136, 146	Cleveland , pinzas cortantes para huesos	73	atrauma pinzas-clamps de usos varios	133
pinzas-clamps para coarctación de titanio	146	Clips vasculares	35, 37 – 39	atrauma pinzas-clamps para preparaciones y ligaduras	120
pinzas-clamps para ligadura	128	Coarctación, pinzas-clamps para	115, 136, 146	cánulas de aspiración	65
pinzas-clamps para oclusión tangencial	129, 151	Collin , costótomos	96	dilatadores vasculares	63
pinzas-clamps para oclusión tangencial de titanio	129	Cone , separadores	55	juego de instrumental para recién nacidos	143
pinzas-clamps para preparaciones y ligaduras	120	Converse , porta-agujas	85	porta-agujas „Micro-Grip“	81
pinzas-clamps para usos varios	133, 138, 147	Cooley , atrauma clamps Bulldog	145, 153	porta-agujas	84, 85
pinzas-clamps para usos varios de titanio	147	atrauma pinzas de disección	113	porta-agujas de titanio	84
pinzas-clamps pediátricos	141 – 143, 152, 154 – 157	atrauma pinzas-clamps para anastomosis	149	separadores costales	103
pinzas-clamps profundales	139	atrauma pinzas-clamps para coarctación	146	tijeras vasculares	10, 14
pinzas-clamps profundales de titanio	139	atrauma pinzas-clamps para coarctación de titanio	146	De Bakey-Bahnson , atrauma pinzas-clamps para aneurisma de aorta	136
pinzas-clamps vasculares	131, 132, 138, 140, 148 – 151	atrauma pinzas-clamps vasculares	138, 148 – 150	De Bakey-Bainbridge , atrauma pinzas-clamps vasculares	121
pinzas-clamps vasculares de titanio	130	atrauma pinzas-clamps para ligadura de titanio	151	De Bakey-Beck , atrauma pinzas-clamps vasculares	131
Atrauma pinzas-clamps vasculares		atrauma pinzas-clamps pediátricos	152	De Bakey-Castaneda , atrauma pinzas-clamps vasculares de titanio	141
		atrauma pinzas-clamps para usos varios	147	De Bakey-Diethrich , atrauma clamps Bulldog	115
		atrauma pinzas-clamps para oclusión tangencial	151	De Bakey-Diethrich , atrauma pinzas de disección	113
		Cooley , cánulas de aspiración	66		

Indice

De Bakey-Gerald , atrauma pinzas de disección.....	113	Gregory , atrauma pinzas-clamps profundales.....	139	atrauma pinzas-clamps bronquiales de titanio.....	126
De Bakey-Rankin , atrauma pinzas-clamps de varios usos.....	138	Gregory-Soft , atrauma clamps Bulldog.....	117	Leksel , pinzas-gubias.....	72
De Bakey-Satinsky , atrauma clamps Bulldog.....	116	Haight , separadores costales.....	102	Leland-Jones , atrauma pinzas-clamps.....	121
De Bakey-Semb , atrauma pinzas-clamps para ligaduras.....	128	Halle , espátulas vasculares.....	61	Lemmon , porta-agujas.....	87
Deaver , espátulas pulmonares.....	52	Halsey , porta-agujas.....	85	Leriche , pinzas hemostáticas pinzas hemostáticas de titanio.....	25
separadores.....	52, 53	porta-agujas de titanio.....	85	Lexer , tijeras, Supercut, TC.....	5
Derra-De Bakey , atrauma pinzas-clamps para anastomosis de titanio.....	139	Halsted-Mosquito , pinzas hemostáticas pinzas hemostáticas de titanio.....	25	tijeras, TC.....	5
Desmarres , ganchos vasculares.....	49	Harken , atrauma pinzas-clamps auriculares.....	125	Lichtenberg , porta-agujas.....	88
Dick , atrauma pinzas-clamps para anastomosis.....	134	pinzas-clamps vasculares.....	111	Ligaduras, tijeras TC.....	4
Diethrich , atrauma pinzas-clamps para aorta.....	124	Harrington , pinzas para preparaciones y ligaduras.....	29	Liston , pinzas cortantes para huesos.....	73
clamps Bulldog.....	36	Harrington , separadores.....	53	Liston-Key , pinzas cortantes para huesos.....	74
pinzas hemostáticas.....	27	Harrington-Baby , separadores.....	53	Little , ganchos vasculares.....	48
porta-agujas.....	90	Harrington-Pemberton , separadores.....	53	Love (Morse) , ganchos vasculares.....	48
Dilatadores de aorta.....	62	Hartmann , pinzas hemostáticas pinzas hemostáticas de titanio.....	26	Lovelace , pinzas-clamps pulmonares.....	110
vasculares.....	63, 64	Harvey , cizallas para cortar alambre.....	76	Markwalder , pinzas cortantes para huesos.....	73
Disección, pinzas de.....	42 - 46	Hegar-Vascular , porta-agujas.....	86	Martin , separadores.....	51
Disectores para venas.....	59	Hegemann , tijeras vasculares.....	14	Masson , porta-agujas.....	87
Doyen , periostótomos.....	69	Heiss , pinzas para preparaciones y ligaduras.....	31	Mathieu-Kocher , porta-agujas.....	88
Duval , pinzas para coger tejidos y órganos.....	92	Henly , atrauma pinzas-clamps para subclavia.....	131	Mathieu-Periostótomos	68
Echlin , pinzas-gubias.....	72	Hepp-Scheidel , porta-agujas.....	90	Mayo , pinzas para coger pulmones.....	46
Embolos, pinzas para.....	63	Hilos para huesos.....	76	tijeras para ligaduras.....	4
Endarterectomia, tijeras para.....	11	Instrumental para huesos.....	68 - 78	tijeras.....	5
Espátulas pulmonares.....	52 - 54, 56	Instrumental para várices.....	59	tijeras, TC.....	5
vasculares.....	60, 61	Instrumental vascular.....	58 - 66	Mayo-Hegar , porta-agujas.....	83, 84
Esternón, tijeras de.....	96, 97	Ima , pinzas de disección „Micro-Grip“.....	42	porta-agujas de titanio.....	83
Estuches para clamps Bulldog para esterilización.....	64	Jacobsen , tijeras vasculares tijeras vasculares de titanio.....	16	McIndoe , pinzas cortantes para huesos.....	73
Eufrate-Pasque , porta-agujas.....	87	Jacobson , porta-agujas.....	90	pinzas de disección de titanio.....	43
Extractores para venas.....	59	porta-agujas „Micro-Grip“.....	80	pinzas de disección sin dientes.....	43
Favaloro , tijeras.....	10	Jacobson-Adson , pinzas hemostáticas.....	27	pinzas de disección „Micro-Grip“.....	42
Fergusson , cánulas de aspiración pinzas para huesos.....	65	Jacobson-Halsted , pinzas hemostáticas.....	25	Mercedes , separadores torácicos.....	104
70		Jameson-Werber , tijeras.....	9	Metzenbaum , tijeras para ligaduras.....	4
Finocchietto , porta-agujas separadores costales.....	88	Javid , pinzas-clamps para carotis.....	144	tijeras para preparaciones.....	6 - 8
101, 105, 107		Jorgensen , tijeras vasculares.....	13	tijeras para preparaciones, Supercut, TC.....	8
Finocchietto-Baby , separadores costales.....	100	Joseph , tijeras.....	9	tijeras para preparaciones, TC.....	6 - 8
Finocchietto-Baby-Haight , separadores costales.....	107	Juego de instrumental para recién nacidos.....	143, 156	Metzenbaum-Fino , tijeras para preparaciones.....	6, 7
Finocchietto-Burford , separadores costales.....	101	Juego para várices.....	58	tijeras para preparaciones, TC.....	6, 7
Finocchietto-Mini , separadores costales.....	100	Kader , separadores.....	53	Micro-Grip pinzas de anillo.....	42
Frazier , cánulas de aspiración.....	65	Kalt , porta-agujas.....	89	pinzas de disección.....	42
Freer , espátulas vasculares.....	60	Kantowitz , pinzas para preparaciones y ligaduras.....	29	porta-agujas.....	80, 81
Frykholm , pinzas-gubias.....	72	Kelly , separadores.....	51	Micro-Mosquito , pinzas hemostáticas pinzas hemostáticas de titanio.....	26
Ganchitos vasculares.....	61	tijeras.....	8	26	
Ganchos para aorta.....	54	Klingenberg-Loth , tijeras vasculares.....	13	Micro-Ryder , porta-agujas porta-agujas de titanio.....	86
vasculares.....	48, 49	tijeras vasculares, TC.....	13	86	
y separadores.....	48 - 54	Kocher , pinzas hemostáticas separadores.....	24	Micro-clamps vasculares.....	37
Ganchos para flebotomía.....	60	50		Micro-clips vasculares.....	38, 39
Garrett , dilatadores vasculares.....	64	Kocher-Langenbeck , separadores.....	50	Micro-espátulas, dobles.....	59
Gemini , pinzas para preparaciones y ligaduras.....	32	Krayenbühl , ganchitos vasculares.....	61	Micro-extractores para venas.....	59
Gerald , pinzas de disección con dientes pinzas de disección con dientes de titanio.....	46	König , ganchos vasculares.....	49	Micro-pinzas de disección.....	43, 44
46		Lahey (Sweet) , pinzas para preparaciones y ligaduras.....	34	Micro-pinzas para sutura.....	45
pinzas de disección sin dientes.....	43	Lambert-Kay , atrauma pinzas-clamps para anastomosis de aorta.....	130	Micro-pinzas-clamps cardiovasculares para niños prematuros.....	142
pinzas de disección sin dientes de titanio.....	43	atrauma pinzas-clamps para anastomosis de aorta de titanio.....	130	Micro-porta-agujas.....	82, 83
Giertz-Stille , costótomos.....	96	Lambotte , periostótomos.....	68	Micro-porta-agujas de titanio.....	83
Gil-Vernet , ganchos vasculares.....	48	Langenbeck , periostótomos.....	68	Micro-tijeras.....	17 - 20
Gillies , pinzas de disección con dientes pinzas de disección con dientes de titanio.....	46	pinzas para huesos.....	70	Micro-tijeras de titanio.....	19, 20
46		separadores.....	50	Microvascular , porta-agujas „Micro-Grip“ ..	81
Glover , atrauma clamps Bulldog.....	116, 145	Langenbeck-Ryder , porta-agujas.....	88	porta-agujas.....	86
atrauma pinzas-clamps para anastomosis.....	129, 135	Lawrence , pinzas para preparaciones y ligaduras.....	34	Mikulic , separadores.....	51
Glover , pinzas-clamps para anastomosis.....	120	Lazar , micro-pinzas de disección.....	45	Millesi , micro-tijeras.....	18
Gluck , costótomos.....	96	Lebsche , cinceles de esternón.....	97	Mills , tijeras vasculares.....	21
		Lees , atrauma pinzas-clamps bronquiales.....	126	Mini-Gemini , pinzas para preparaciones y ligaduras.....	32
				Mini-extractores para venas.....	59
				Mixer , pinzas para preparaciones y ligaduras.....	33
				Mixer O'Shaughnessy , pinzas para preparaciones y ligaduras.....	33
				Morris-De Bakey , atrauma pinzas-clamps para anastomosis de aorta.....	135
				Morse , separadores costales.....	106
				Morse-Favaloro , separadores costales.....	104, 106

Indice



Mosquito , atrauma pinzas hemostáticas .. 137	-clamps para aorta... 28, 124, 127, 128, 139	Ryder , porta-agujas „Micro-Grip“ .. 81
Müller , aproximadores .. 39	-clamps para aorta,	porta-agujas .. 86
clips vasculares .. 38	atrauma .. 124, 127, 128, 139	Santulli , atrauma clamps Bulldog .. 117
Myers , sondas para várices .. 58	-clamps para aorta de titanio, atrauma .. 139	Sarot , pinzas hemostáticas .. 28
Nabatoff , juego para várices .. 58	-clamps para carotis .. 144	porta-agujas .. 87
Nelson , pinzas de disección .. 46	-clamps para coarctación .. 119, 136, 146	Satinsky , pinzas-clamps vasculares .. 111
Ochsner , atrauma pinzas clamps para	-clamps para coarctación,	tijeras vasculares .. 13
aorta .. 124	atrauma .. 119, 136, 146	Satinsky/De Bakey , atrauma pinzas-
Ochsner-Kocher , pinzas	-clamps para coarctación de titanio,	clamps para oclusión tangencial .. 129
hemostáticas .. 24	atrauma .. 146	Sauerbruch , costótomos .. 96
Overholt , pinzas para	-clamps para ligadura ... 127, 128, 138, 151	pinzas-gubias .. 72
preparaciones y ligaduras .. 30	-clamps para ligadura de titanio,	separadores .. 52
Overholt-Geissendörfer , pinzas para	atrauma .. 128, 151	Sawtell , pinzas para preparaciones y
preparaciones y ligaduras .. 31	-clamps para oclusión tangencial,	ligaduras .. 33
Overholt-Mixter , pinzas para prepara-	atrauma .. 129, 151	Schmid , cánulas de irrigación para vasos .. 59
ciones y ligaduras .. 31	-clamps para oclusión tangencial de	espátulas vasculares .. 60
Overholt-Slim , pinzas para prepara-	titanio, atrauma .. 129	Schwartz , pinzas para poner clamps .. 36
ciones y ligaduras .. 30	-clamps para preparaciones y ligadura,	Sellers , aproximadores para costillas .. 108
Pean , pinzas hemostáticas .. 24	atrauma .. 120	Semb , periostótomos .. 69
Periféricas, pinzas-clamps vasculares .. 139	-clamps para subclavia, atrauma .. 131	pinzas cortantes para huesos .. 74
Periostótomos .. 68, 69	-clamps para usos varios .. 133, 138, 147	pinzas para huesos .. 70
Pinzas .. 24 – 39	-clamps para usos varios,	pinzas para preparaciones y ligaduras .. 110
atraumaticas .. 113, 114	atrauma .. 133, 138, 147	pinzas-gubias .. 71
cortantes para huesos .. 73, 74	-clamps para usos varios de titanio,	Separadores .. 55, 56
de disección .. 42 – 46	atrauma .. 147	costales .. 100 – 107
de disección „Micro-Grip“ .. 42	-clamps pediátricos .. 141 – 143, 152,	de esternón para recién nacidos,
de disección con dientes .. 46	154 – 157	de titanio .. 108
de disección de titanio .. 43, 44, 46	-clamps pediátricos, atrauma .. 152	para aurícula .. 54
de disección sin dientes .. 43 – 45	-clamps pediátricos y para recién	para huesos .. 50
de disección, micro .. 43, 44	nacidos .. 154, 155	torácicos .. 104
de disección con anillos .. 42	-clamps pediátricos y para recién	Simon , separadores .. 51
de titanio .. 25, 26, 28	nacidos, atrauma .. 154, 155	Singley-Tuttle , pinzas para coger tejidos .. 46
hemostáticas .. 24 – 28	-clamps profundos, atrauma .. 139	Sondas para endarterectomia .. 59
para aorta .. 28	-clamps pulmonares .. 110	para várices .. 58
para aplicar micro-clamps	-clamps vasculares .. 110, 111	Stille , costótomos .. 96
vasculares .. 37 – 39	-clamps vasculares,	pinzas-gubias .. 72
para coger émbolos .. 63	atrauma .. 130 – 132, 138, 140, 148 – 151	Stille-Liston , pinzas cortantes para huesos 74
para coger tejidos y órganos .. 92, 93	-clamps vasculares con bocas	Stille-Luer , pinzas-gubias .. 71
para huesos .. 70	intercambiables .. 158	Stille-Ruskin , pinzas-gubias .. 71
para poner clips .. 115	-clamps vasculares de titanio .. 130, 131	Struck , separadores costales .. 100
para poner micro-clips .. 35, 36	-clamps vasculares, micro, atrauma .. 142	Strully , tijeras vasculares .. 21
para preparaciones y	-clamps vasculares pediátricos y para	Subclavia, pinzas-clamps para .. 131
ligaduras .. 26, 27, 29 – 35, 110, 120	recién nacidos .. 141	Subramanian-Miniature , atrauma
para preparaciones y para arterias	-clamps vasculares periféricos,	pinzas-clamps para aorta .. 139
coronarias .. 33	atrauma .. 139	atrauma
para tumores .. 44	-gubias .. 71, 72	pinzas-clamps para aorta de titanio .. 139
-clamps atraumaticos de titanio .. 119 – 122,	Porta-agujas .. 80 – 90	Tangencial, pinzas-clamps para
126, 128 – 131, 141, 142, 146, 147, 151	Potts , atrauma pinzas para coarctación .. 119	oclusión .. 129, 151
-clamps auriculares .. 125	atrauma pinzas-clamps .. 119	Tejidos, pinzas de disección para coger .. 45
-clamps auriculares, atrauma .. 125	pinzas-clamps para coarctación .. 119	Tijeras .. 2 – 21
-clamps bronquiales .. 110, 126	Potts-De Martel , tijeras vasculares .. 21	coronarias .. 10
-clamps bronquiales, atrauma .. 126	Potts-Smith , pinzas de disección sin	estandar .. 2, 3
-clamps bronquiales de titanio,	dientes .. 45	de esternón .. 96
atrauma .. 126	Potts-Smith , tijeras-vasculares .. 10, 12, 13	finas .. 9
-clamps cardiovasculares, atrauma .. 141	tijeras vasculares, Supercut .. 11	finas, Supercut .. 9
-clamps cardiovasculares de titanio,	tijeras vasculares, TC .. 12	micro .. 17 – 20
atrauma .. 141	Price-Thomas , pinzas-clamps	micro- TC .. 4
-clamps de titanio, atrauma .. 129	bronquiales .. 110	micro- de titanio .. 19, 20
-clamps hemostáticas, atrauma .. 137	Profundos, pinzas-clamps .. 139	para cirugía .. 2, 3, 8
-clamps para anastomosis de	Pulmones, pinzas de disección para coger .. 46	para cirugía, TC .. 2, 3
aorta .. 130, 135	Punzonadoras aórticas .. 62	para endarterectomia, Supercut .. 11
-clamps para anastomosis,	Recién nacidos, instrumental para .. 143, 156	para ligaduras, TC .. 4
atrauma .. 120, 129, 134, 135, 139, 149	pinzas-clamps para .. 157	para preparaciones .. 5 – 8
-clamps para	Reynolds , tijeras .. 9	para preparaciones, Supercut, TC .. 5
anastomosis .. 120, 129, 134, 139, 149	tijeras, Supercut .. 9	para preparaciones, TC .. 5, 8
-clamps para anastomosis de aorta,	Rienhoff-Finocchietto , separadores	para venotomia .. 18
atrauma .. 130	costales .. 102	Supercut .. 11
-clamps para anastomosis de titanio,	Rochester-Pean , pinzas hemostáticas .. 24	vasculares .. 10, 12 – 16, 21
atrauma .. 139	Ross , separadores .. 54	Tijeras vasculares de titanio .. 15, 16, 19, 20
-clamps para anastomosis de aorta	Rudolf , porta-agujas .. 86	vasculares, TC .. 12 – 14
de titanio, atrauma .. 130	Rumel , pinzas para preparaciones y	Tijeras titanio .. 15, 16, 19, 20
Pinzas-clamps para aneurisma de	ligaduras .. 29	Titanio, clamps Bulldog atraumaticos .. 118
aorta .. 122, 123, 136	Rumel-Belmont , torniquetes .. 66	pinzas de disección .. 43, 44, 46
-clamps para aneurisma de	Ruskin-Liston , pinzas cortantes para	Titanio, pinzas-clamps .. 119 – 122, 126,
aorta, atrauma .. 122, 123, 136	huesos .. 74	atraumaticos .. 128 – 131, 139, 141, 142,

Indice

.....	146, 147, 151
pinzas	25, 26, 28
porta-agujas.....	83 – 86, 89
separadores de esternón para recién nacidos	108
tijeras	15, 16, 19, 20
Toennis , espátulas vasculares.....	60
Torniquetes.....	66
Tubbs , dilatadores de aorta.....	62
Tubos de aspiración.....	66
Tumores, pinzas para	44
Tönnis , porta-agujas.....	88
Tönnis-Adson , tijeras vasculares, TC.....	13
Universal , cizallas para cortar alambre	76
Usos varios, pinzas clamps para.....	133, 138, 147
Varady , disectores para venas.....	59
extractores para venas	59
instrumental para várices	59
micro-espátulas	59
micro-extractores para venas	59
mini-extractores para venas.....	59
Venotomía, tijeras para.....	18
Volkman , separadores.....	50
Wangensteen , pinzas de disección sin dientes	45
Wangensteen , porta-agujas	87
Weber , atrauma pinzas-clamps para aorta.....	128
Weitlaner , separadores.....	55, 56
Wertheim , atrauma pinzas-clamps para anastomosis	134
Wickstroem , pinzas para preparaciones y ligaduras	34
Williams , pinzas para coger tejidos y órganos.....	93
Wylie , atrauma pinzas-clamps vasculares.....	123
Yankauer , cánulas de aspiración.....	65
Zenker , separadores.....	53
Zweifel , porta-agujas	88

Table des matières



Acland Mod. , clamps micro-vasculaires.....	37	Ciseaux.....	2 – 21	pincés-clamps à usage multiple.....	133
Adson , écarteurs.....	55	Clamps à disséquer pour les artères		pincés-clamps atraumatiques pour	
pincés à disséquer Micro-Grip.....	42	coronaires.....	33	l'anévrisme.....	122
pincés à disséquer atraumatiques.....	113	atraumatiques bulldog, titane.....	118	pincés-clamps atraumatiques pour	
pincés à disséquer, titane.....	43	atraumatiques bulldog.....	115 – 118, 145, 153	l'anévrisme de l'aorte.....	122, 123
pincés à disséquer.....	43	bulldog.....	35, 115 – 118, 145, 153	pincés-clamps atraumatiques pour	
pincés à griffes, titane.....	46	micro-vasculaires atraumatiques.....	142	l'anévrisme de l'aorte, titane.....	122
pincés à griffes.....	46	Cleveland , pincés coupantes à os.....	73	pincés-clamps	
pincés hémostatiques.....	26	Coolin , costotomes.....	96	atraumatiques.....	121, 130, 131, 138, 140
Adson-Brown , pincés à griffes.....	46	Cone , écarteurs.....	55	pincés-clamps atraumatiques à	
pincés à griffes, titane.....	46	Converse , porte-aiguilles.....	85	ligature.....	127
Alexander , rugines.....	68	Cooley , boîtes à instruments pour des		pincés-clamps atraumatiques à	
Allis-Atrauma , pincés à tissu et à		nouveaux-nés.....	156	préparation et à ligature.....	120
saisir les organes.....	92	canules d'aspiration.....	66	pincés-clamps pour l'aorte.....	127
Allison , spatules pulmonaires.....	56	clamps atraumatiques bulldog.....	145, 153	porte-aiguilles Micro-Grip.....	81
Alm , écarteurs.....	55	dilatateurs aortiques.....	62	porte-aiguilles, titane.....	84
Approximateurs.....	37, 39	écarteurs costaux.....	102, 105	porte-aiguilles.....	84, 85
Babcock , pincés à tissu et à saisir		écarteurs pour auricles cardiaques.....	54	De Bakey-Bahson , pincés-clamps atrau-	
les organes.....	92	écarteurs.....	54	matiques pour l'anévrisme de l'aorte.....	136
Babcock-Atrauma , pincés à tissu et		pincés à disséquer atraumatiques.....	113	De Bakey-Bainbridge , pincés-clamps	
à saisir les organes.....	92	pincés-clamps atraumatiques pour		atraumatiques.....	121
Baby-Adson , pincés hémostatiques.....	26	l'anastomose.....	149	De Bakey-Beck , pincés-clamps	
Baby-Crile-Wood , porte-aiguilles.....	85	pincés-clamps atraumatiques pour		atraumatiques.....	131
Baby-Hegemann , ciseaux vasculaires.....	14	la coarctation.....	146	De Bakey-Castaneda , pincés-clamps	
Baby-Mixter , pincés à préparation et à		pincés-clamps atraumatiques pour		atraumatiques cardiovasculaires, titane.....	141
ligature.....	32	la coarctation, titane.....	146	De Bakey-Diethrich , clamps atraumatiques	
Baby-Satinsky , pincés vasculaires.....	111	pincés-clamps		bulldog.....	115
Bailey , rapprocheurs costaux.....	108	atraumatiques.....	138, 148 – 150	pincés à disséquer atraumatiques.....	113
Bailey-Baby , rapprocheurs costaux.....	108	pincés-clamps atraumatiques		De Bakey-Gerald , pincés à disséquer	
Bailey-Gibbon , rapprocheurs costaux.....	108	néonatales.....	152	atraumatiques.....	113
Barraquer , porte-aiguilles.....	90	pincés-clamps atraumatiques		De Bakey-Pean , pincés atraumatiques	
Beck , pincés-clamps atraumatiques, titane	130	à ligature, titane.....	151	hémostatiques.....	137
pincés-clamps atraumatiques.....	130, 150	pincés-clamps atraumatiques		De Bakey-Rankin , pincés-clamps	
Bengolea , pincés hémostatiques.....	27	à usage multiple.....	147	atraumatiques à usage multiple.....	138
Bethune , costotomes.....	97	pincés-clamps atraumatiques		De Bakey-Satinsky , clamps atraumatiques	
Biemer , micro-serre-fines.....	39	à usage multiple, titane.....	147	bulldog.....	116
Biemer-Müller , micro-approximateurs.....	39	pincés-clamps atraumatiques pour		De Bakey-Semb , pincés-clamps	
Blake , pincés à saisir le caillot.....	63	l'occlusion tangentielle.....	151	atraumatiques à ligature.....	128
Blocage de sécurité.....	119	pincés-clamps pour la carotide.....	144	Deaver , écarteurs.....	52, 53
Boîtes à instruments pour des		Cooley-Derra , pincés-clamps		spatules pulmonaires.....	52
nouveaux-nés.....	143, 156	atraumatiques.....	151	Derra-De Bakey , pincés-clamps atrau-	
à stérilisation.....	64	Coryllos , écarteurs.....	52	matiques pour l'anastomose, titane.....	139
pour clamps bulldog.....	160	Costotomes.....	96, 97	Desmarres , crochets.....	49
Borowski , crochets aortiques.....	54	Crafoord , pincés hémostatiques.....	28	Désoblitérateurs de veines.....	58
Bozemann , porte-aiguilles.....	83	pincés hémostatiques, titane.....	28	Dick , pincés-clamps atraumatiques	
Bridge , pincés hémostatiques.....	28	Crafoord-Sellors , pincés pour l'aorte.....	28	pour l'anastomose.....	134
Brunner , ciseaux à sternum.....	97	Craford , écarteurs.....	51	Diethrich , clamps bulldog.....	35
Burford , écarteurs costaux.....	107	Crile , crochets pour les vaisseaux.....	61	pincés hémostatiques.....	27
Böhler , pincés coupantes à os.....	73	Crile-Wood , porte-aiguilles.....	85	pincés-clamps atraumatiques pour	
Canules d'aspiration pour des vaisseaux		Crochets à veines.....	61	l'aorte.....	124
d'aspiration.....	65	aortiques.....	54	porte-aiguilles.....	90
Canules d'irrigation.....	59	Crochets.....	48, 49	Dilatateurs aortiques.....	62
Castaneda , écarteurs costaux.....	106	Crochets Phlebectomie.....	60	vasculaires.....	63, 64
pincés-clamps néonatales.....	157	Cushing , crochets.....	48, 61	Doyen , rugines.....	69
Castroviejo , porte-aiguilles Micro-Grip.....	80	pincés à disséquer.....	45	Duval , pincés à tissu et à saisir les	
porte-aiguilles, titane.....	89	Cushing-Kocher , crochets.....	49	organes.....	93
porte-aiguilles.....	89, 90	Dale , pincés-clamps atraumatiques		Ecarteurs à os.....	50
Ciseaux à dissection, Supercut, TC.....	5	périphériques.....	139	à sternum pour des nouveaux-nés,	
à dissection, TC.....	2, 3, 5 – 8	pincés-gouges.....	72	titane.....	108
à dissection.....	2, 3, 5 – 8	Dardik , pincés-clamps atraumatiques.....	132	costaux.....	100 – 108
à endartérectomie, Supercut.....	11	écarteurs.....	54	pour auricules cardiaques.....	54
à fils.....	76	Davidson-Alexander , rugines.....	68	thoraciques.....	104
à ligature, TC.....	4	Daviers porte-os.....	70	Ecarteurs.....	48 – 56
à sternum.....	96	Davis , spatules pour les vaisseaux.....	60	Echlin , pince-gouges.....	72
à veines.....	18	De Bakey , boîtes à instruments pour des		Emporte-pièces aortiques.....	62
chirurgicaux, TC.....	2, 3	nouveaux-nés.....	143	Eufrate-Pasque , porte-aiguilles.....	87
chirurgicaux.....	2, 3, 8	canules d'aspiration.....	65	Ferguson , canules d'aspiration.....	65
coronaires.....	10	ciseaux vasculaires, TC.....	14	daviers porte-os.....	70
fins, Supercut.....	9	ciseaux vasculaires.....	10, 14	Fils à os.....	76
fins.....	9	clamps atraumatiques bulldog.....	116, 117	Finocchietto , écarteurs	
vasculaires, TC.....	12 – 14	dilatateurs vasculaires.....	63	costaux.....	101, 105, 107
vasculaires, titane.....	15, 16	écarteurs costaux.....	103	Finocchietto , porte-aiguilles.....	88
vasculaires.....	10, 12 – 16, 21	pincés à disséquer atraumatiques,		Finocchietto-Baby , écarteurs costaux.....	100
Supercut.....	11	titane.....	113, 114	Finocchietto-Baby-Haight , écarteurs	
titane.....	15, 16, 19, 20	pincés à disséquer atraumatiques.....	113, 114	costaux.....	107

Table des matières

Finocchietto-Burford , écarteurs costaux	101	Lambert-Kay , pinces-clamps atraumatiques pour l'anastomose de l'aorte, titane.....	130	Mixer O'Shaugnessy , pinces à préparation et à ligature.....	33
Finocchietto-Mini , écarteurs costaux	100	pinces-clamps atraumatiques pour l'anastomose de l'aorte.....	130	Mixer , pinces à préparation et à ligature.....	33
Frazier , canules d'aspiration.....	65	Lambotte , rugines.....	68	Morris-De Bakey , pinces-clamps atraumatiques pour l'anastomose de l'aorte.....	135
Freer , spatules à vaisseaux.....	60	Langenbeck , daviers porte-os.....	70	Morse , écarteurs costaux	106
Frykholm , pinces-gouges.....	72	écarteurs.....	50	Morse-Favoloro , écarteurs costaux ..	104, 106
Garrett , dilataleurs vasculaires.....	64	rugines.....	68	Mosquito , pinces atraumatiques hémostatiques	137
Gemini , pinces à préparation et à ligature ..	32	Langenbeck-Ryder , porte-aiguilles.....	88	Myers , désoblitérateurs de veines	58
Gerald , pinces à disséquer, titane.....	43	Lawrence , pinces à préparation et à ligature.....	34	Müller , approximateurs	39
pinces à disséquer.....	43	Lazar , micro-pinces à disséquer.....	45	serre-fines.....	38
pinces à griffes, titane.....	46	Lebsche , ciseau-burins à sternum.....	97	Nabatoff , trousse à veines	58
pinces à griffes.....	46	Lees , pinces-clamps atraumatiques à bronches.....	126	Nelson , pinces à saisir.....	46
Giertz-Stille , costotomes.....	96	pinces-clamps atraumatiques à bronches, titane.....	126	Ochsner , pinces-clamps atraumatiques pour l'aorte.....	124
Gil-Vernet , crochets.....	48	Leksell , pinces-gouges.....	72	Ochsner-Kocher , pinces hémostatiques... ..	24
Gillies , pince à griffes, titane.....	46	Leland-Jones , pinces-clamps atraumatiques.....	121	Overholt , pinces à préparation et à ligature.....	30
pinces à griffes.....	46	Leimon , porte-aiguilles.....	87	Overholt-Geissendörfer , pinces à préparation et à ligature.....	31
Glover , clamps atraumatiques bulldog ..	116, 145	Leriche , pinces hémostatiques.....	25	Overholt-Mixer , pinces à préparation et à ligature.....	31
pinces-clamps atraumatiques pour l'anastomose.....	129, 135	pinces hémostatiques, titane	25	Overholt-Slim , pinces à préparation et à ligature.....	30
pinces-clamps pour l'anastomose	120	Lexer , ciseaux, Supercut, TC.....	5	Pean , pinces hémostatiques.....	24
Gluck , costotomes.....	96	ciseaux, TC.....	5	Phlébo-dissecteurs	59
Gregory , pinces-clamps atraumatiques profondales.....	139	Lichtenberg , porte-aiguilles.....	88	Phlébo-extracteurs	59
Gregory-Soft , clamps atraumatiques bulldog	117	Liston , pinces coupantes à os.....	73	Pinces à disséquer Micro-Grip	42
Haight , écarteurs costaux.....	102	Liston-Key , pinces coupantes à os.....	74	à disséquer annulaires Micro-Grip.....	42
Halle , spatules à vaisseaux.....	61	Little , crochets.....	48	à disséquer annulaires.....	42
Halsey , porte-aiguilles, titane.....	85	Love (Morse) , crochets.....	48	à disséquer atraumatiques, titane.....	113
porte-aiguilles	85	Lovelace , pinces-clamps à poumons	110	à disséquer atraumatiques	113, 114
Halsted-Mosquito , pinces hémostatiques.....	25	Markwalder , pinces coupantes à os.....	73	à disséquer pour tumeurs.....	44
pinces hémostatiques, titane	25	Martin , écarteurs.....	51	à disséquer, Micro-Grip	42
Harken , pinces vasculaires	111	Masson , porte-aiguilles.....	87	à disséquer, titane.....	43, 44, 46
pinces-clamps atraumatiques auriculaires	125	Mathieu-Kocher , porte-aiguilles.....	88	à disséquer.....	42 - 46
Harrington , écarteurs.....	53	Matson , rugines.....	68	à fils	76 - 78
pinces à préparation et à ligature	29	Mayo , ciseaux à ligature.....	4	à griffes	46
Harrington-Baby , écarteurs.....	53	ciseaux, TC.....	5	à poser les clips.....	37 - 39, 115
Harrington-Pemberton , écarteurs.....	53	ciseaux.....	5	à préparation et à ligature.....	26, 27, 29 - 36, 110, 120
Hartmann , pinces hémostatiques.....	26	pinces à saisir les poumons.....	46	à saisir le caillot	63
pinces hémostatiques, titane	26	Mayo-Hegar , porte-aiguilles, titane	83, 84	à saisir les poumons	46
Harvey , ciseaux à fils.....	76	porte-aiguilles	83	à saisir les tumeurs.....	44
Hegar-Vasculair , porte-aiguilles.....	86	Mc Indoe , pinces à disséquer Micro-Grip.....	42	à saisir	45
Hegemann , ciseaux vasculaires.....	14	pinces à disséquer, titane	43	à tissu et à saisir les organes	92, 93
Heiss , pinces à préparation et à ligature.....	31	pinces à disséquer.....	43	atraumatiques à préparation et à ligature.....	120
Henly , pinces-clamps atraumatiques subclaviculaires	131	pinces coupantes à os	73	atraumatiques hémostatiques.....	137
Hepp-Scheidel , porte-aiguilles	90	Mercedes , écarteurs thoraciques	104	atraumatiques subclaviculaires.....	131
Instruments à os	68 - 78	Metzenbaum , ciseaux à dissection, TC ..	6 - 8	atraumatiques vasculaires, titane	130
pour les varices.....	59	ciseaux à dissection, TC, Supercut.....	8	atraumatiques vasculaires	131, 132, 138,
vasculaires.....	58 - 66	ciseaux à dissection.....	6 - 8	140, 148 - 151
Ima , Pinces à disséquer Micro-Grip	42	ciseaux à ligature.....	4	coupantes à os	73, 74
Jacobsen , ciseaux vasculaires, titane	16	Metzenbaum-Fino , ciseaux à dissection ..	6, 7	coupantes latérales et frontales.....	78
ciseaux vasculaires.....	16	ciseaux à dissection, TC	6, 7	hémostatiques	24 - 28
Jacobson , porte-aiguilles Micro-Grip	80	ciseaux à dissection, TC.....	6, 7	néonatales	157
porte-aiguilles	90	Micro-Mosquito , pinces hémostatiques	26	pédiatriques	141, 143, 152, 154 - 157
Jacobson-Adson , pinces hémostatiques.....	27	pinces hémostatiques, titane	26	pour poser les serre-fines.....	35, 36
Jacobson-Halsted , pinces hémostatiques.....	25	Micro-Ryder , porte-aiguilles, titane	86	subclaviculaires	131
Jameson-Werber , ciseaux.....	9	porte-aiguilles	86	vasculaires avec des mors interchangeable	158
Javid , pinces-clamps pour la carotide.....	144	Micro-porte-aiguilles.....	19, 20	vasculaires.....	110, 111
Jorgensen , ciseaux vasculaires	13	Micro-ciseaux.....	17 - 20	Pinces-clamps à bronches	110, 126
Joseph , ciseaux.....	9	Micro-ciseaux.....	17 - 20	Pinces-clamps à poumons	110
Kader , écarteurs.....	53	Micro-phlébo-extracteurs.....	59	à usage multiple.....	133, 138, 147
Kalt , porte-aiguilles	89	Micro-pinces à disséquer.....	43, 44	atraumatiques pour l'anastomose.....	120,
Kantrowitz , pinces à préparation et à ligature.....	29	à suture.....	45	129, 134, 135, 139, 149
Kelly , ciseaux.....	8	Micro-porte-aiguilles	82, 83	atraumatiques pour l'anastomose de l'aorte.....	130, 135
écarteurs.....	51	Micro-serre-fines pour prématurés	142	atraumatiques pour l'anastomose de l'aorte, titane.....	130
Klingenberg-Loth , ciseaux vasculaires, TC	13	Micro-serre-fines.....	37 - 39		
ciseaux, vasculaires.....	13	Micro-spatules	59		
Kocher , écarteurs.....	50	Microvascular , porte-aiguilles Micro-Grip ..	81		
Kocher , pinces hémostatiques.....	24	porte-aiguilles.....	86		
Kocher-Langenbeck , écarteurs.....	50	Mikulicz , écarteurs	51		
Krayenbühl , crochets	61	Millesi , micro-ciseaux	18		
König , crochets.....	49	Mills , ciseaux vasculaires	21		
Lahey (Sweet) , pinces à préparation et à ligature.....	34	Mini-Gemini , pinces à préparation et à ligature.....	32		
		Mini-phlébo-extracteurs	59		

Table des matières



atraumatiques pour l'anévrisme de l'aorte.....	122, 123, 136
atraumatiques pour l'aorte.....	124, 127, 128, 139
atraumatiques auriculaires.....	125
atraumatiques bronchiques, titane.....	126
atraumatiques bronchiques.....	126
atraumatiques pour la coarctation, titane.....	146
atraumatiques cardiovasculaires.....	141
atraumatiques cardiovasculaires, titane.....	141
atraumatiques pour la pédiatrie.....	141 – 143, 152, 154 – 157
atraumatiques pour la ligature, titane.....	151
atraumatiques pour la ligature.....	127, 128, 138, 151
atraumatiques à usage multiple, titane.....	147
atraumatiques à usage multiple.....	133, 138, 147
atraumatiques néonatales et pédiatriques.....	154, 155
atraumatiques périphériques.....	139
atraumatiques profondales, titane.....	139
atraumatiques profondales.....	139
atraumatiques pour l'occlusion tangentielle.....	129, 151
atraumatiques pour la ligature, titane.....	128
atraumatiques pour l'occlusion tangentielle, titane.....	129
atraumatiques, titane.....	119 – 122, 126, 128 – 131, 139, 142, 146, 147, 151
atraumatiques.....	119 – 157
auriculaires.....	125
cardiovasculaires pour des enfants et des nouveaux nés.....	141
pour l'anastomose.....	120, 129, 134, 139, 149
pour l'anastomose de l'aorte.....	130, 135
pour l'anévrisme de l'aorte.....	122, 123, 136
pour l'aorte.....	28, 124, 127, 128, 139
pour l'occlusion tangentielle.....	129, 151
pour la carotide.....	144
pour la coarctation.....	119, 136, 146
profondales.....	139
vasculaires périphériques.....	139
Pincés-gouges.....	71, 72
Porte-aiguilles Micro-Grip.....	80, 81
titane.....	83 – 86, 89
Porte-aiguilles.....	80 – 90
Potts , pincés-clamps atraumatiques pour la coarctation.....	119
pincés-clamps atraumatiques.....	119
pincés-clamps pour la coarctation.....	119
Potts-De Martel , ciseaux vasculaires.....	21
Potts-Smith , ciseaux vasculaires, Supercut 11 ciseaux vasculaires, TC.....	12
ciseaux vasculaires.....	10, 12, 13
pincés à disséquer.....	45
Price-Thomas , pincés-clamps à bronches.....	110
Rapprocheurs costaux.....	108
Reynolds , ciseaux, Supercut.....	9
ciseaux.....	9
Rienhoff-Finocchietto , écarteurs costaux.....	102
Rochester-Pean , pincés hémostatiques.....	24
Ross , écarteurs.....	54
Ruban silicone.....	160
Rudolf , porte-aiguilles.....	86
Rugines.....	68, 69
Rumel , pincés à préparation et à ligature.....	29
Rumel-Belmont , tourniquets.....	66
Ruskin-Liston , pincés coupantes à os.....	74
Ryder , porte-aiguilles Micro-Grip.....	81
porte-aiguilles.....	86
Santulli , clamps atraumatiques bulldog.....	117
Sarot , pincés hémostatiques.....	28
porte-aiguilles.....	87
Satinsky , ciseaux vasculaires.....	13
pincés-clamps vasculaires.....	111
Satinsky/De Bakey , pincés-clamps atraumatiques pour l'occlusion tangentielle.....	129
Sauerbruch , costotomes.....	96
écarteurs.....	52
pincés-gouges.....	72
Sawtell , pincés à préparation et à ligature.....	33
Schmid , canules d'irrigation vasculaires.....	59
spatules vasculaires.....	60
Schwartz , pincés à poser les serre-fines.....	35
Sellors , rapprocheurs costaux.....	108
Semb , daviers porte-os.....	70
pincés à préparation et à ligature.....	110
pincés coupantes à os.....	74
pincés-gouges.....	71
rugines.....	69
Serre-fines.....	36 – 39
Simon , écarteurs.....	51
Singley-Tuttle , pincés à saisir.....	46
Sondes pour endartérectomie.....	59
Spatules pour les vaisseaux.....	60, 61
pulmonaires.....	52 – 54, 56
Stille , costotomes.....	96
pincés-gouges.....	72
Stille-Liston , pincés coupantes à os.....	74
Stille-Luer , pincés-gouges.....	71
Stille-Ruskin , pincés-gouges.....	71
Struck , écarteurs costaux.....	100
Strully , ciseaux vasculaires.....	21
Subramanian-Miniature , pincés-clamps atraumatiques pour l'aorte.....	139
pincés-clamps atraumatiques pour l'aorte, titane.....	139
Toennis , spatules vasculaires.....	60
Tourniquets.....	66
Trousses à veines.....	58
Tubbs , dilateurs aortiques.....	62
Tubes d'aspiration.....	66
Tönnis , porte-aiguilles.....	88
Tönnis-Adson , ciseaux vasculaires, TC.....	13
Universal , ciseaux à fils.....	76
Varady , instruments pour les varices.....	59
micro-phlébo-extracteurs.....	59
micro-spatules.....	59
mini-phlébo-extracteurs.....	59
phlébo-dissécteurs.....	59
phlébo-extracteurs.....	59
Volkman , écarteurs.....	50
Wangensteen , pincés à disséquer.....	45
porte-aiguilles.....	87
Weber , pincés-clamps atraumatiques pour l'aorte.....	128
Weitlaner , écarteurs.....	55, 56
Wertheim , pincés-clamps atraumatiques pour l'anastomose.....	134
Wickstroem , pincés à préparation et à ligature.....	34
Williams , pincés à tissu et à saisir les organes.....	92
Wylie , pincés-clamps atraumatiques.....	123
Yankauer , canules d'aspiration.....	65
Zenker , écarteurs.....	53
Zweifel , porte-aiguilles.....	88

Indice

Acland micro clips vascolare	37	set strumenti per neonati	156	Divaricatori per sterno per neonati, titanio	108
Adson divaricatori	55	tubi d'aspirazione	66	Doyen periostomi	69
micro-pinze	42	Cooley-Baby divaricatori costali	102, 105	Duval pinze per afferrare tessuti ed organi	93
pinze anatomiche	43	Cooley-Derra pinze cardiovascolari		Echlin pinze-sgorbie	72
pinze cardiovascolari atraumatiche	113	atraumatiche	151	Estrattore flebo	59
pinze chirurgiche	46	Cooley-Glover pinze atraumatiche		Eufrate-Pasque portaghi	87
pinze emostatiche	26	Bulldog	145	Favaloro forbici	10
Adson-Baby (Cone) divaricatori	55	Coryllos divaricatori	52	Fergusson tenaglie per ossa	70
Adson-Brown pinze chirurgiche	46	Costotomi	95 - 97	tubi d'aspirazione	65
Alexander periostomi	68	Crafoord pinze per bronchi	28	Filo per ossa	76
Alexander-Davidson periostomi	68	Crafoord-Sellors pinze per aorta	28	Finocchietto divaricatori costali	101
Allis-Atrauma pinze per afferrare tessuti		Crawford divaricatori	51	divaricatori costali modificato	105
ed organi	92	Crile uncini	61	divaricatori costali in alluminio	107
Allison spatole per polmone	56	Crile-Wood portaghi	85	portaghi	88
Alm divaricatori	55	Cushing pinze anatomiche	45	Finocchietto-Baby divaricatori costali	100
Approssimatore costali	108	uncini	48, 61	Finocchietto-Baby-Haight divaricatori	
Approssimatore per micro-clips	37, 39	Cushing-Kocher divaricatori	49	costali in alluminio	107
Astuccio per le vene	58	Dale pinze cardiovascolari atraumatiche	139	Finocchietto-Burford divaricatori costali	101
Babcock (Standard) pinze per afferrare		pinze-sgorbie	72	Finocchietto-Mini divaricatori costali	100
tessuti ed organi	92	Dardik pinze cardiovascolari atraumatiche	132	Flebo-estrattore	59
Babcock-Atrauma pinze per afferrare		Davidson divaricatori auricolare	54	Forbici	2 - 21
tessuti ed organi	92	Davidson-Alexander periostomi	68	coronari	10
Baby-Adson pinze emostatiche	26	Davis spatole vascolari	60	fine	9 - 21
Baby-Cooley divaricatori costali	102	Deaver (Grip-Handle) divaricatori	53	per chirurgia	2 - 3, 5 - 8
Baby-Crile-Wood portaghi	85	Deaver divaricatori	52	per chirurgia e dissezione	2 - 3,
Baby-Finocchietto divaricatori costali	100	De Bakey dilatatori vascolari	63	(tungsteno)	5 - 8
Baby-Haight divaricatori costali	107	divaricatori costali	103	per endarterectomia	11
Baby-Harrington divaricatori	53	forbici vascolari	10, 14	per fili metallici	76
Baby-Hegemann forbici vascolari	14	pinze atraumatiche Bulldog	116, 117	per le vene	18
Baby-Mixer pinze per dissezione	32	pinze cardiovascolari		per legature	4
Baby-Satinsky pinze cardiovascolari	111	atraumatiche	113 - 117, 119 - 142	per preparazione	7 - 8, 20
Bahnson-De Bakey pinze per		pinze per aneurisma dell'aorta	122 - 123	per sterno	96
aneurisma dell'aorta	136	pinze per aorta	127	Supercut	11
Bailey approssimatori costali	108	pinze per preparazioni e legature	120, 127	vascolari	10 - 16
Bailey-Baby approssimatori costali	108	pinze per vari usi	133	Frazier tubi d'aspirazione	65
Bailey-Gibbon divaricatori costali	108	portaghi	81, 84, 85	Freer spatole	60
Banco di silicone solo	160	tubi d'aspirazione	65	Frykholm pinze-sgorbie	72
Barraquer portaghi	90	De Bakey-Bahnson pinze per aneurisma		Garret dilatatori vascolari	64
Beck pinze cardiovascolari atraumatiche		dell'aorta	136	Gemini pinze per dissezione	32
titanio	130, 150	De Bakey-Bainbridge pinze	121	Gerald pinze anatomiche	43
Bengolea pinze per preparazione	27	De Bakey-Bayonet pinze cardiovascolari		pinze chirurgiche	46
Bethune costotomi	97	atraumatiche	113	Giertz-Stille forbici per sterno	96
Biemer micro-serrafini	39	De Bakey-Beck pinze cardiovascolari		Gil-Vernet divaricatori	48
Biemer-Müller micro-approssimatori	39	atraumatiche	131	Gillies pinze chirurgiche	46
Blake pinze per afferrare ad embolia	63	De Bakey-Bridge pinze cardiovascolari		Glover (Potts) pinze per anastomosi	120
Borowski divaricatori auricolare	54	atraumatiche	121	Glover pinze atraumatiche Bulldog	116
Bozemann portaghi	83	De Bakey-Castaneda pinze titanio per		pinze cardiovascolari atraumatiche	135
Bridge pinze emostatiche	28	bambini e neonati	141	pinze per anastomosi	129
Brunner forbici per sterno	97	De Bakey-Diethrich pinze atraumatiche		Gluck costotomi	96
Burford divaricatori costali in alluminio	107	Bulldog	115	Gregory pinze per profondità	139
Böhler pinze cesoie per ossa	73	pinze per cardiovascolari atraumatiche	113	Gregory-Soft pinze atraumatiche Bulldog	117
Castaneda divaricatori costali	106	De Bakey-Fine portaghi	84	Haight divaricatori costali	102
pinze per neonati	157	De Bakey-Gerald pinze cardiovascolari		Halle spatole	61
Castaneda-De Bakey pinze per bambini		atraumatiche	113	Halsey portaghi	85
e neonati	141	De Bakey-Beck pinze atraumatiche	131	Halsted-Mosquito pinze emostatiche	25
Castroviejo forbici	2, 3, 8	De Bakey-Pean pinze cardiovascolari		Harken pinze cardiovascolari	111, 126
pinze	46	atraumatiche	137	pinze per padiglione auricolare	
portaghi	80, 89 - 90	De Bakey-Rankin pinze per vari usi	138	atraumatiche	125
Chiusura di sicurezza per pinze	119	De Bakey-Satinsky pinze atraumatiche		Harrington divaricatori	53
Cleveland pinze cesoie per ossa	73	Bulldog	116	pinze per dissezione	29
Collin costotomi	96	De Bakey-Semb pinze per legature	128	Harrington-Baby divaricatori	53
Cone (Adson-Baby) divaricatori	55	pinze per legature titanio	128	Harrington-Pemberton divaricatori	53
Converse portaghi	85	Derra-De Bakey pinze per anastomosi	139	Hartmann pinze emostatiche	26
Cooley dilatatori vascolari	62	Desmarres divaricatori	49	Harvey forbici per fili metallici	76
divaricatori auricolare	54	Dick pinze cardiovascolari atraumatiche	134	Hegar portaghi vascolari	86
divaricatori costali	102, 105	Diethrich forbici vascolari	14	Hegar-Vascular portaghi	86
pinze atraumatiche Bulldog	145	pinze Bulldog	35	Hegemann (Diethrich) forbici vascolari	14
pinze cardiovascolari	113,	pinze per dissezione	27	Heiss pinze per dissezione	31
atraumatiche	144 - 156	pinze per aorta atraumatiche	124	Henly pinze per subclavia	131
pinze per anastomosi	149	portaghi	90	Hepp-Scheidel portaghi	90
pinze per coartazione	146	Dilatatori vascolari	62 - 64	Horsley pinze cesoie per ossa	74
pinze per legature	151	Divaricatori	47 - 56	Ima , pinze Micro-Grip	42
pinze per occlusioni tangenziale	151	Divaricatore auricolare	54	Jacobsen micro forbici vascolari	16
pinze per vari usi	147	costali	99 - 108	portaghi	80, 90
Cooley pinze per vari usi atraumatiche titanio	147	per aorta	54	Jacobsen-Adson pinze emostatiche	27

Indice



Jacobsen-Halsted pinze emostatiche.....	25	Millesi micro-forbici.....	18	Pinze-sgorbie.....	71 – 72
Jameson-Werber forbici.....	9	Mills forbici vascolari.....	21	Placche di ricambio.....	158
Javid pinze per la carotide.....	144	Mini-estrattore per flebo.....	59	Portaghi.....	79 – 90
Jorgensen forbici vascolari.....	13	Mini-Finocchetto divaricatori costali.....	100	Micro-Grip.....	80 – 81
Joseph forbici.....	9	Mini-Gemini pinze per dissezione.....	32	Micro-vascolare.....	81
Kader divaricatori.....	53	Mixer pinze per dissezione.....	33	Potts pinze cardiovascolari atraumatiche.....	119
spatole per polmone.....	53	Mixer-O'Shaugnessy pinze per		Potts-De-Martel forbici vascolari.....	21
Kalt portaghi.....	89	dissezione.....	33	Potts-De Bakey pinze cardiovascolari	
Kantrowitz pinze emostatiche.....	29	Morris-De Bakey pinze anastomosi aorta.....	135	atraumatiche.....	119
Kelly divaricatori.....	51	Morse divaricatori.....	48	Potts-Smith forbici vascolari.....	10, 13
forbici.....	8	divaricatori costali in alluminio.....	106	pinze anatomiche.....	45
Klingenberg-Loth forbici vascolari.....	13	Morse-Favaloro divaricatori costali.....	104	Price-Thomas pinze per bronchi.....	110
Kocher divaricatori.....	49 – 50	divaricatori costali alluminio.....	106	Punzonatrice vascolari.....	62
pinze emostatiche.....	24	Mosquito pinze cardiovascolari		Reynolds forbici.....	9
Kocher-Langenbeck divaricatori.....	50	atraumatiche.....	137	Rienhoff-Finocchetto divaricatori costali.....	102
Krayenbühl uncini.....	61	pinze emostatiche atraumatiche.....	137	Rochester-Pean pinze emostatiche.....	24
König divaricatori.....	49	Myers sonda per vene.....	58	Ross divaricatori per aorta.....	54
Lahey (Sweet) pinze per dissezione.....	34	Müller micro-approssimatori.....	39	Rudolf (Swedisch-Pattern) portaghi	
Lambert-Kay pinze anastomosi aorta.....	130	serrafini.....	58	vascolare.....	86
Lambotte periostomi.....	68	Nabatoff astuccio per le vene.....	58	Rumel pinze per dissezione.....	29
Langenbeck divaricatori.....	50	Nelson pinze chirurgiche.....	46	Rumel-Belmont tornichetti.....	66
periostomi.....	68	Ochsner pinze per aorta.....	124	Ruskin-Liston pinze cesoie per ossa.....	74
tenaglie per ossa.....	70	Ochsner-Kocher pinze emostatiche.....	24	Ryder portaghi.....	81, 86
Langenbeck-Ryder portaghi.....	88	Overholt-Geissendörfer pinze per		Santulli pinze atraumatiche Bulldog.....	117
Lawrence pinze per dissezione.....	34	dissezione.....	31	Sarot pinze emostatiche.....	28
Lazar pinze anatomiche.....	45	Overholt-Mixer pinze per dissezione.....	31	portaghi.....	87
Lebsche forbici per sterno.....	97	Overholt-S pinze per dissezione.....	30	Satinsky forbici vascolari.....	13
Lees pinze per bronchi atraumatiche.....	126	Overholt-Slim pinze per dissezione.....	30	pinze cardiovascolari.....	111
Leksell pinze-sgorbie.....	72	Pean pinze emostatiche.....	24	Satinsky/De Bakey pinze per occlusione	
Leland-Jones pinze cardiovascolari		Pean-De Bakey pinze emostatiche		tangenziale.....	129
atraumatiche.....	121	atraumatiche.....	137	Sauerbruch divaricatori.....	52
Lemmon portaghi.....	87	Periostomi.....	68 – 69	forbici per sterno.....	96
Leriche pinze emostatiche.....	25	Pinze anastomosi aorta.....	130	pinze-sgorbie.....	72
Lexer forbici.....	5	anatomiche.....	41 – 46	Sawtell pinze per dissezione.....	33
Lichtenberg portaghi.....	88	anatomiche per sutura.....	45	Scalpello per sterno.....	97
Liston pinze cesoie per ossa.....	73	atraumatiche.....	113 – 156	Scatole per pinze Bulldog.....	159 – 160
Liston-Key (Horsley) pinze cesoie per		atraumatiche Bulldog.....	115, 118, 145	Schmid canule per irrigazione per varici.....	59
ossa.....	74	Bulldog.....	35	spatole vascolari.....	60
Little uncini.....	48	cardiovascolari atraumatiche.....	112	Schwartz pinze.....	35
Love (Morse) divaricatori.....	48	cardiovascolari.....	109 – 158	Sellors approssimatore costali.....	108
Lovelace pinze per polmone.....	110	cesoie per ossa.....	73 – 74	Semb periostomi.....	69
Markwalder pinze-cesoie per ossa.....	73	chirurgiche a denti di topo.....	46	pinze.....	110
Martin divaricatori.....	51	emostatiche.....	23 – 28	pinze cesoie per ossa.....	74
Masson portaghi.....	87	klemmer.....	24	pinze-sgorbie.....	71
Mathieu-Kocher portaghi.....	88	Micro-Grip.....	42	tenaglie per ossa.....	70
Matson periostomi.....	68	Micro-vascolari atraumatiche per		Serrafini.....	36 – 39
Mayo forbici (tungsteno).....	4 – 5	prematuri.....	142	Simon divaricatori.....	51
pinze per polmone.....	46	per afferrare tessuti.....	45	Singley-Tuttle pinze anatomiche.....	46
Mayo-Hegar portaghi.....	83, 84	per afferrare ad embolia.....	63	Sonde per endarterectomia.....	59
McIndoe micro-pinze.....	42	per afferrare tessuti ed organi.....	91 – 93	per vene.....	58
pinze anatomiche.....	43	per anastomosi.....	120, 123, 143, 135,	Spatole per polmone.....	53, 56
pinze cesoie per ossa.....	73	136, 139		vascolari.....	59 – 61
Mercedes divaricatori costali.....	104	per aneurisma dell'aorta.....	122 – 123, 136	Stille costotomi.....	96
Mercedes-Retractor divaricatori costali.....	104	per aorta.....	28, 124, 127 – 128	pinze-sgorbie.....	72
Metzenbaum forbici tungsteno.....	4 – 8	per applicare clips.....	115	Stille-Liston pinze cesoie per ossa.....	74
Metzenbaum-Fino forbici.....	6 – 8	per bronchi.....	110, 126	Stille-Luer Pinze-sgorbie.....	71
Micro-Approssimatori.....	39	per coartazione.....	119, 136, 146	Stille-Ruskin Pinze-sgorbie.....	71
-clips vascolare.....	36 – 39	per dissezione coronari.....	33	Struck divaricatori costali.....	100
-estrattore per vene (flebo).....	59	per dissezione e legature.....	26 – 27	Strully forbici vascolari.....	21
-forbici.....	15 – 20	per fill.....	76 – 77	Strumenti ossea.....	67 – 78
-forbici per le vene.....	18	per la carotide.....	144	per fili.....	75 – 78
-forbici per preparazione.....	20	per legature.....	127, 128, 138	per varici.....	59
-forbici titanio.....	19	per occlusione tangenziale.....	129, 151	vascolari.....	57 – 66
-forbici vascolari.....	15 – 21	per padiglione auricolare.....	125	Subranian-Miniature pinze per aorta.....	129
-spatole doppie per flebo.....	59	per polmone.....	46, 110	Swedish Pattern portaghi vascolare.....	86
Micro-Grip portaghi.....	80 – 81	per posizionare micro clips.....	36 – 38	Sweet (Lahey) pinze per dissezione.....	24
Micro-Mosquito pinze emostatiche.....	26	per preparazioni e legature.....	120	Tenaglie per ossa.....	70
Micro-Pinze anatomiche.....	42 – 45	per profondità.....	139	tagliafili.....	78
-pinze con anelli.....	42	per subclavia.....	131	Toennis-Adson forbici vascolari.....	13
Micro-Pinze per sutura.....	45	per tumore.....	44	Toennis portaghi.....	88
Micro-portaghi.....	80 – 83, 89 – 90, 93	per vari usi.....	133, 138, 147	spatole.....	60
Micro-Ryder portaghi vascolare.....	86	periferiche.....	139	Tornichetti.....	66
Micro-Serrafini.....	38 – 39	vascolari atraumatiche.....	109 – 158	Tronchese tagliafili.....	78
Microvascular portaghi.....	81, 86	vascolari con placche intercambiabili.....	158	Tubbs dilatatori vascolari.....	62
Mikulicz divaricatori.....	51	Pinze-Micro con anelli.....	42	Tubi d'aspirazione.....	66

Indice



Uncini.....	48 – 50
vascolari.....	48 – 49, 61
Unico per phlebectomia.....	60
Universal forbici per fili metallici.....	76
Varady micro-estrattore.....	59
strumenti flebo.....	59
Vena-Arteria pinze atraumatiche Bulldog	
titanio.....	118
Volkman divaricatori.....	50
Wangensteen pinze anatomiche.....	45
portaghi.....	87
Weber pinze per aorta.....	128
Weitlaner divaricatori.....	55 – 56
Wertheim pinze per anastomosi.....	134
Wickstroem pinze per dissezione.....	24
Williams pinze per afferrare tessuti ed	
organi.....	92
Wylie pinze per aneurisma dell'aorta.....	123
Yankauer tubi d'aspirazione.....	65
Zenker divaricatori.....	53
Zweifel portaghi.....	88



Nummernverzeichnis
Numerical index
Indice numérico
Table numérique
Indice numerico



Nummernverzeichnis
 Numerical index
 Índice numérico
 Table numérique
 Índice numerico



Katalog-Nr.	Seite	Katalog-Nr.	Seite	Katalog-Nr.	Seite	Katalog-Nr.	Seite	Katalog-Nr.	Seite
Cat. no.	page	Cat. no.	page	Cat. no.	page	Cat. no.	page	Cat. no.	page
No. ref.	página	No. ref.	página	No. ref.	página	No. ref.	página	No. ref.	página
No. réf.	page	No. réf.	page	No. réf.	page	No. réf.	page	No. réf.	page
No. rif.	pagina	No. rif.	pagina	No. rif.	pagina	No. rif.	pagina	No. rif.	pagina
RU 1001-14	2	RU 1331-30	7	RU 1760-16	14	RU 2383-18 TI	19	RU 3111-12	25
RU 1001-15	2	RU 1334-18	7	RU 1760-19	14	RU 2385-18	19	RU 3111-12 TI	25
RU 1001-16	2	RU 1334-18 MC	8	RU 1761-13	14	RU 2386-16	20	RU 3111-18	25
RU 1002-14	2	RU 1334-18 RS	4	RU 1761-16	14	RU 2386-16 TI	20	RU 3111-21	25
RU 1002-15	2	RU 1334-20	7	RU 1761-19	14	RU 2387-16	20	RU 3114-13	25
RU 1002-16	2	RU 1334-20 MC	8	RU 1762-13	14	RU 2387-16 TI	20	RU 3115-13	25
RU 1003-14	2	RU 1334-23	7	RU 1762-16	14	RU 2388-14	19	RU 3120-10	26
RU 1003-15	2	RU 1334-23 MC	8	RU 1762-19	14	RU 2389-14	20	RU 3120-12	26
RU 1003-16	2	RU 1334-23 RS	4	RU 1763-13	14	RU 2490-21	21	RU 3121-10	26
RU 1004-14	2	RU 1334-25	7	RU 1763-16	14	RU 2491-21	21	RU 3121-12	26
RU 1006-14	2	RU 1334-26 RS	4	RU 1763-19	14	RU 2496-22	21	RU 3121-12 TI	26
RU 1008-14	2	RU 1334-28	7	RU 1764-16	14	RU 2497-22	21	RU 3122-10	26
RU 1011-14	3	RU 1334-30	7	RU 1764-19	14	RU 2600-12	76	RU 3122-12	26
RU 1011-15	3	RU 1336-18	7	RU 1765-19	14	RU 2601-12	76	RU 3123-10	26
RU 1011-16	3	RU 1336-20	7	RU 1770-25	15	RU 2610-12	76	RU 3123-12	26
RU 1012-14	3	RU 1336-23	7	RU 1770-45	15	RU 2805-22	96	RU 3123-12 TI	26
RU 1012-15	3	RU 1336-25	7	RU 1770-60	15	RU 2820-22	96	RU 3123-12 TI	26
RU 1012-16	3	RU 1336-28	7	RU 1770-90	15	RU 2825-21	96	RU 3140-10	26
RU 1013-14	3	RU 1339-15	8	RU 1770-99	15	RU 3000-16	24	RU 3140-10 TI	26
RU 1013-15	3	RU 1339-18	8	RU 1771-25	15	RU 3000-18	24	RU 3141-10	26
RU 1013-16	3	RU 1339-20	8	RU 1771-25 TI	15	RU 3000-20	24	RU 3141-10 TI	26
RU 1014-14	3	RU 1339-23	8	RU 1771-45	15	RU 3000-22	24	RU 3201-18	26
RU 1016-14	3	RU 1339-26	8	RU 1771-45 TI	15	RU 3000-24	24	RU 3205-14	26
RU 1018-14	3	RU 1440-18	8	RU 1771-60	15	RU 3000-26	24	RU 3205-18	26
RU 1103-16	5	RU 1441-18	8	RU 1771-60 TI	15	RU 3001-16	24	RU 3206-00	27
RU 1103-16 MC	5	RU 1580-15	9	RU 1771-90	15	RU 3001-18	24	RU 3206-18	27
RU 1250-14	5	RU 1580-15 MC	9	RU 1771-90 TI	15	RU 3001-20	24	RU 3207-18	27
RU 1250-17	5	RU 1580-18	9	RU 1771-99	15	RU 3001-22	24	RU 3208-01	27
RU 1250-23	5	RU 1581-15	9	RU 1771-99 TI	15	RU 3001-24	24	RU 3208-02	27
RU 1250-28	5	RU 1581-18	9	RU 1772-25	15	RU 3001-26	24	RU 3208-03	27
RU 1251-14	5	RU 1582-15 MC	9	RU 1772-45	15	RU 3010-16	24	RU 3208-11	27
RU 1251-17	5	RU 1584-13	9	RU 1772-60	15	RU 3010-18	24	RU 3240-20	27
RU 1251-23	5	RU 1670-14	9	RU 1772-90	15	RU 3010-20	24	RU 3240-22	27
RU 1251-28	5	RU 1671-14	9	RU 1772-99	15	RU 3010-22	24	RU 3240-24	27
RU 1252-14	5	RU 1705-11	10	RU 1773-25	15	RU 3010-24	24	RU 3240-26	27
RU 1252-17	5	RU 1710-19	10	RU 1773-45	15	RU 3010-26	24	RU 3241-20	27
RU 1252-23	5	RU 1713-15	10	RU 1773-60	15	RU 3011-18	24	RU 3241-22	27
RU 1253-14	5	RU 1714-15	10	RU 1773-90	15	RU 3011-19	24	RU 3241-24	27
RU 1253-14 RS	4	RU 1715-15	10	RU 1773-99	15	RU 3011-20	24	RU 3241-26	27
RU 1253-17	5	RU 1718-17 MC	11	RU 1829-17	13	RU 3011-22	24	RU 3242-20	27
RU 1253-17 RS	4	RU 1720-19	12	RU 2350-18	16	RU 3011-24	24	RU 3242-22	27
RU 1253-23	5	RU 1720-19 MC	11	RU 2350-18 TI	16	RU 3011-26	24	RU 3242-24	27
RU 1253-23 RS	4	RU 1721-19	12	RU 2351-18	16	RU 3020-13	24	RU 3242-26	27
RU 1291-14	6	RU 1721-19 MC	11	RU 2351-18 TI	16	RU 3020-14	24	RU 3243-20	27
RU 1304-14	6	RU 1722-19	12	RU 2352-18	16	RU 3021-13	24	RU 3243-22	27
RU 1314-14	6	RU 1722-19 MC	11	RU 2360-19	16	RU 3021-14	24	RU 3243-24	27
RU 1314-14 MC	8	RU 1723-19	12	RU 2361-19	16	RU 3030-13	24	RU 3243-26	27
RU 1314-14 RS	4	RU 1724-25	12	RU 2362-19	16	RU 3030-14	24	RU 3246-27	28
RU 1316-14	6	RU 1724-45	12	RU 2364-19	16	RU 3031-13	24	RU 3247-27	28
RU 1324-18	7	RU 1724-60	12	RU 2365-19	16	RU 3031-14	24	RU 3270-24	28
RU 1324-20	7	RU 1735-19	13	RU 2370-01/13	18	RU 3080-15	25	RU 3271-24	28
RU 1324-23	7	RU 1739-22	13	RU 2370-16	17	RU 3080-15 TI	25	RU 3274-22	28
RU 1324-25	7	RU 1740-24	13	RU 2370-18	17	RU 3081-15	25	RU 3274-23	28
RU 1324-28	7	RU 1744-23	13	RU 2371-16	17	RU 3081-15 TI	25	RU 3274-24	28
RU 1324-30	7	RU 1745-23	13	RU 2371-18	17	RU 3082-15	25	RU 3275-18	28
RU 1326-18	7	RU 1750-16	14	RU 2372-16	17	RU 3082-15 TI	25	RU 3275-24	28
RU 1326-20	7	RU 1750-23	14	RU 2373-16	17	RU 3083-15	25	RU 3275-24 TI	28
RU 1326-23	7	RU 1750-28	14	RU 2375-18	17	RU 3083-15 TI	25	RU 3276-01	29
RU 1326-25	7	RU 1752-16	14	RU 2376-16	18	RU 3100-12	25	RU 3276-02	29
RU 1326-28	7	RU 1752-23	14	RU 2377-16	18	RU 3100-12 TI	25	RU 3279-19	29
RU 1330-18	7	RU 1754-16	14	RU 2380-14	19	RU 3100-18	25	RU 3279-24	29
RU 1330-20	7	RU 1754-23	14	RU 2380-16	19	RU 3100-21	25	RU 3279-26	29
RU 1330-23	7	RU 1754-28	14	RU 2381-16	19	RU 3101-12	25	RU 3280-01	29
RU 1330-25	7	RU 1755-25	14	RU 2382-16	19	RU 3101-12 TI	25	RU 3280-02	29
RU 1330-28	7	RU 1755-45	14	RU 2382-18	19	RU 3101-18	25	RU 3280-03	29
RU 1331-18	7	RU 1755-60	14	RU 2382-18 TI	19	RU 3101-21	25	RU 3280-04	29
RU 1331-20	7	RU 1756-25	14	RU 2382-23	19	RU 3110-12	25	RU 3280-05	29
RU 1331-23	7	RU 1756-45	14	RU 2382-23 TI	19	RU 3110-12 TI	25	RU 3290-00/01	30
RU 1331-25	7	RU 1756-60	14	RU 2383-16	19	RU 3110-18	25	RU 3290-00/02	30
RU 1331-28	7	RU 1760-13	14	RU 2383-18	19	RU 3110-21	25	RU 3290-00/03	30

Katalog-Nr..... Seite
Cat. no.....page
No. ref..... página
No. réf.....page
No. rif.....pagina

RU 7771-20	63
RU 7771-25	63
RU 7771-30	63
RU 7771-35	63
RU 7771-40	63
RU 7771-45	63
RU 7771-50	63
RU 7771-70	63
RU 7771-90	63
RU 7773-00	64
RU 7773-02	64
RU 7773-04	64
RU 7773-06	64
RU 7773-08	64
RU 7773-10	64
RU 7773-12	64
RU 7773-14	64
RU 7773-16	64
RU 7773-18	64
RU 7773-20	64
RU 7773-22	64
RU 7773-24	64
RU 7773-26	64
RU 7773-28	64
RU 7773-30	64
RU 7773-32	64
RU 7773-34	64
RU 7773-36	64
RU 7773-38	64
RU 7773-98	64
RU 7773-99	64
RU 7780-01	66
RU 7780-02	66
RU 7780-03	66
RU 7780-04	66
RU 7780-05	66
RU 7787-32	66
RU 7787-64	66
RU 8204-16	61
RU 8216-18	60
RU 8825-07	61
RU 8825-08	61
RU 8825-09	61
RU 8850-01	61
RU 8850-02	61
RU 8916-11	160
RU 8917-01	160









RUDOLF MEDICAL GmbH + Co. KG

Zollerstraße 1 · 78567 Fridingen, Germany · Phone +49 (74 63) 99 56-0
Fax +49 (74 63) 99 56-56 · mail@rudolf-med.com · www.rudolf-med.com

rudolf[®]
MEDICAL