

TONTARRA

ENDOSCOPY



UROLOGY

ABOUT US

For more than 50 years “made by TONTARRA, Germany” is a synonym for state-of-the-art surgical and endoscopic instruments and equipment.

This success and the international recognition of the skillfulness in surgical and endoscopic instrument making of Tontarra Medizintechnik GmbH are based on our commitment to medical innovation, mastery in manufacturing, and a strong focus on our continuing tradition of excellence.

The confidence in our surgical and endoscopic lines as expressed by our international customers, distribution- and OEM-partners are a driving force to face and meet new challenges.

TONTARRA



Indispensable ‘tools’ for maturing new ideas into high-precision surgical instruments of highest precision include our state-of-the-art manufacturing facility and production processes, and especially the comprehensive technical know-how, ingenuity and strong commitment of our entire team.

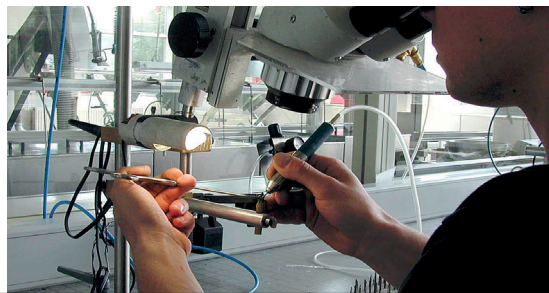

ICONS – OVERVIEW



Function length



LuerLock



Quick Lock



For use with sheath in size



Round sheath



Oval sheath



Drop style sheath



For use with laser



Continuous flow

TABLE OF CONTENT

<p>▶ Quick Lock connecting system 4</p> <hr/> <p>▶ Telescopes HD / HD+ / HD+2 5 – 8</p> <p>Uretero - Renoscopes Nephroscopes</p> <p>▶ Cystoscopy 17 Fr. - 25 Fr. 9 – 22</p> <p>Lithotripsy 24 Fr. - 25.5 Fr.</p> <p>▶ Resectoscopy Ø 4 mm 23 – 38</p> <p>24/26 Fr. & 27/28.5 Fr.</p> <p>▶ Resectoscopy Ø 2.9 mm 39 – 42</p> <p>19/22 Fr.</p> <p>▶ Mini-Resectoscopy Ø 2.9 mm 43 – 48</p> <p>17.5/18.5 Fr.; with extra working channel for cystoscopy</p>	<p>▶ Instruments for Laser Therapy 49 – 56</p> <p>Laser-Cystoscopy 23 Fr. Laser-Resectoscopy 24/26 Fr. & 27/28.5 Fr. Laser-Urethrotomy 21 Fr.</p> <p>▶ Urethrotomy 57 – 62</p> <p>21 Fr./15.5 Fr.</p> <p>▶ Uretero-Renoscopy 63 – 66</p> <p>21 Fr./15.5 Fr.</p> <p>▶ Nephroscopy 67 – 80</p> <p>Systems for Ø 2.8 mm telescopes 24 & 26 Fr. Systems for Ø 1.8 mm telescopes 23 Fr. Mini-Nephroscopy 18 Fr./19.5 Fr./24 Fr.</p> <p>▶ Pediatric Urology 81 – 90</p> <p>Cysto-Urethroscopy 13 Fr. /11 Fr./9.5 Fr./7.5 Fr. Resectoscopy 13 Fr. /11 Fr./9 Fr. Visual Urethrotomy 13 Fr. /11 Fr.</p> <p>▶ HF Generator 91 – 94</p> <p>PWT -400 Plasma Wave</p> <p>▶ Accessories 95 – 101</p> <p>General urologic accessories; Light guide cables & Connectors; HF cables; Maintenance, Storage & Sterilization</p> <p>▶ Index 102 – 103</p>
--	---

THE QUICK LOCK CONNECTING SYSTEM



The Quick-Lock connection system's main feature is the easy assembly and disassembly of the urological sheaths. The spring mechanism allows the optimal centering of the inner and outer sheaths. Above mentioned points are the main advantages of the Quick-Lock mechanism compared to the well-known Bayonet-type lock.

Each sheath is marked with an „arrow“ on the locking cone to indicate the correct assembly position.

The Quick Lock system is characterized by a smooth running take apart and a tight sealing as soon as the sheaths are connected to each other.





TELESCOPES

- ◀ HD
- ◀ HD+
- ◀ HD+2

FLEXIBLE FIBERSCOPES

URETERO-RENOSCOPES

UROLOGY TELESCOPES HD+, HD+2



- ▶ Ø 4.0 mm / Ø 2.9 mm / Ø 2.7 mm / Ø 2.0 mm
- ▶ Compatible with most instrument- and camera systems

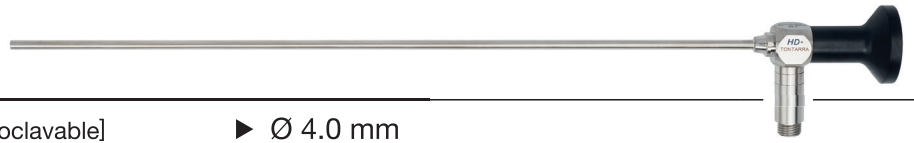

TELESCOPES FOR UROLOGY [autoclavable] ▶ Ø 4.0 mm

Description			Art. No.	· For use in cystoscopy and resectoscopy · Field of view: 70° · Available in four different angles of view
Telescope HD+	▶ Ø 4.0 mm; 0°	FL 300 mm	601-104-00HD	
Telescope HD+2	▶ Ø 4.0 mm; 0°	FL 300 mm	601-104-00HD2	
Telescope HD+	▶ Ø 4.0 mm; 12°	FL 300 mm	601-104-12HD	
Telescope HD+2	▶ Ø 4.0 mm; 12°	FL 300 mm	601-104-12HD2	
Telescope HD+	▶ Ø 4.0 mm; 30°	FL 300 mm	601-104-30HD	
Telescope HD+2	▶ Ø 4.0 mm; 30°	FL 300 mm	601-104-30HD2	
Telescope HD+	▶ Ø 4.0 mm; 70°	FL 300 mm	601-104-70HD	
Telescope HD+2	▶ Ø 4.0 mm; 70°	FL 300 mm	601-104-70HD2	

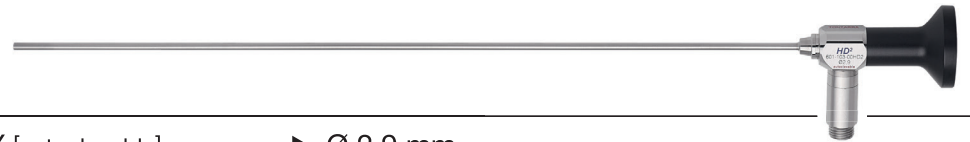
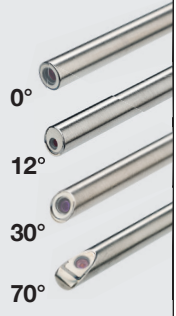

TELESCOPES FOR UROLOGY [autoclavable] ▶ Ø 2.9 mm

Description			Art. No.	· For use in cystoscopy and resectoscopy · Field of view: 80° · Available in four different angles of view
Telescope HD+2	▶ Ø 2.9 mm; 0°	FL 300 mm	601-103-00HD2	
Telescope HD+2	▶ Ø 2.9 mm; 12°	FL 300 mm	601-103-12HD2	
Telescope HD+2	▶ Ø 2.9 mm; 30°	FL 300 mm	601-103-30HD2	
Telescope HD	▶ Ø 2.9 mm; 70°	FL 300 mm	601-103-70	

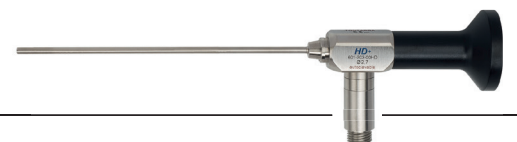

TELESCOPES FOR UROLOGY [autoclavable] ▶ Ø 2.7 mm

Description			Art. No.	For use with TONTARRA's pediatric Uro-Line.
Telescope HD+	▶ Ø 2.7 mm; 0°	FL 187.5 mm	601-203-00HD	
Telescope HD+	▶ Ø 2.7 mm; 30°	FL 187.5 mm	601-203-30HD	

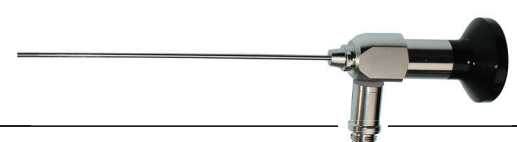

TELESCOPES FOR UROLOGY [autoclavable] ▶ Ø 2.0 mm

Description			Art. No.	For miniature cystoscopes and mini operative systems (e. g. to be used with TONTARRA's pediatric Uro-Line).
Telescope HD	▶ Ø 2.0 mm; 0°	FL 187 mm	601-102-00	
Telescope HD	▶ Ø 2.0 mm; 30°	FL 187 mm	601-102-30	

FLEXIBLE FIBERSCOPES



Flexible Cystoscope



Flexible Uretero-Renoscope

FLEXIBLE FIBERSCOPES [autoclavable]

Description		Art. No.		
FLEXIBLE CYSTOSCOPE ▶ Ø 5.5 mm; 0° ▶ Working channel Ø 2.3 mm ▶ Angulation up/down 210°/120°	FL 380 mm Field of view 100°	EMTO/FCS-5523R	· Excellent image quality · Resistant shaft and guiding part · Slightly offset deflection tip	
FLEXIBLE URETERO-RENSCOPE ▶ Ø 7.5 Fr; 0° ▶ Working channel Ø 3.6 Fr. ▶ Angulation up/down 275°/275°	FL 680 mm Field of view 88°	EMTO/FURS-2812R		· Sterilizable with EtO-Gas and Steris®
BRIDGE ▶ with LUER-connector ▶ 2 stopcocks		087-940-07		

URETERO-RENSCOPES

- ▶ 30.000 pixel
- ▶ 2 working channels (1x 4 Fr. and 1x 5 Fr.)



TELESCOPES FOR UROLOGY [autoclavable]

Description		Art. No.		
URETERO-RENSCOPE [1 working channel 5 Fr.] ▶ 8.0/9.8 Fr.; 12° ▶ 8.0/9.8 Fr.; 12°	FL 315 mm	601-110-05		
	FL 430 mm	601-110-10		
URETERO-RENSCOPE [1 working channel 4 Fr.] ▶ 6.0/7.5 Fr.; 12° ▶ 6.0/7.5 Fr.; 12°	FL 315 mm	601-110-15		
	FL 430 mm	601-110-20		
AUTOMATIC VALVE (DUCKBILL) for Ureterorenoscopes 1 box = 10 pcs.		499-196-00		

HD NEPHROSCOPES

- ▶ ACMI®-Wolf®-Storz® and Olympus® light port adapters
- ▶ Autoclavable

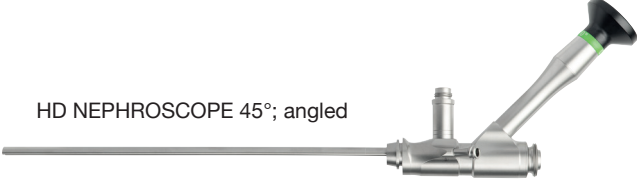
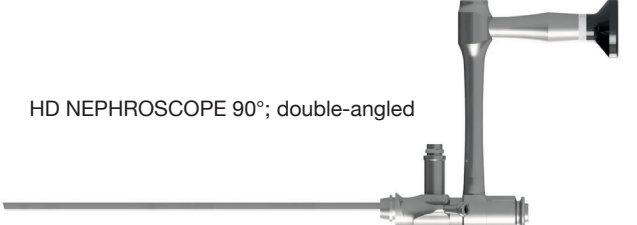

HD NEPHROSCOPES Ø 2.8 mm ▶ working channel Ø 5.0 mm 24 Fr. /26 Fr.

Description		Art. No.	Information
HD NEPHROSCOPE ▶ 45° angled	FL 200 mm	601-130-45	 <p>HD NEPHROSCOPE 45°; angled</p>
HD NEPHROSCOPE ▶ 45° angled	FL 250 mm	601-140-45	
HD NEPHROSCOPE ▶ 90° double-angled	FL 200 mm	601-130-90	 <p>HD NEPHROSCOPE 90°; double-angled</p>
HD NEPHROSCOPE ▶ 90° double-angled	FL 250 mm	601-140-90	

COMPACT NEPHROSCOPES Ø 1.8 mm ▶ working channel Ø 4.3 mm 23 Fr.

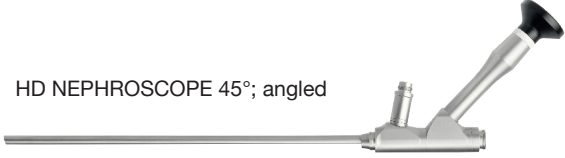
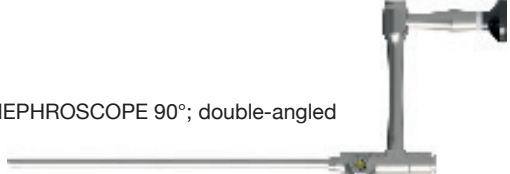
Description		Art. No.	Information
HD NEPHROSCOPE ▶ 45° angled	FL 220 mm	601-135-45	 <p>HD NEPHROSCOPE 45°; angled</p>
HD NEPHROSCOPE ▶ 90° double-angled	FL 220 mm	601-135-90	
			 <p>HD NEPHROSCOPE 90°; double-angled</p>

MINI COMPACT NEPHROSCOPES ▶ working channel Ø 2.2 mm 18 Fr./19.5 Fr./24 Fr.

Description		Art. No.	Information
HD MINI COMPACT NEPHROSCOPE; direction of view 0°; 40.000 pixels; shaft Ø 4,0mm (12 Fr.); with fix instrument bridge and integrated stopcock	FL 220 mm	601-145-30	

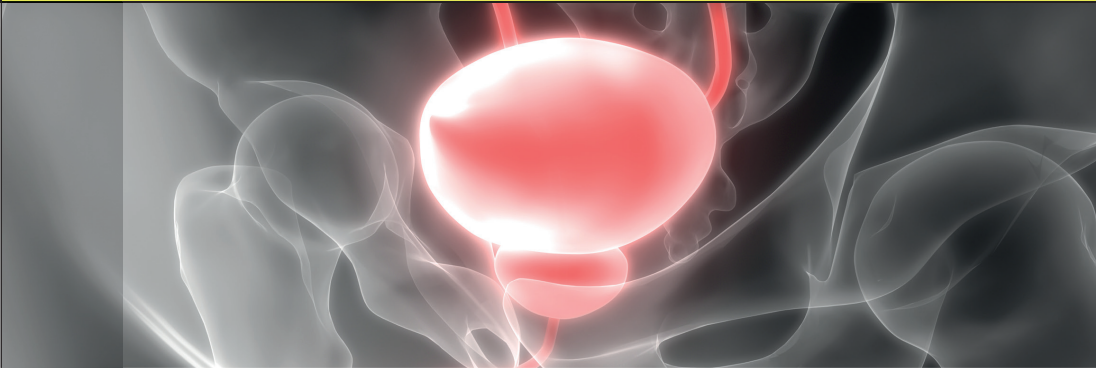

CYSTOSCOPY

◀ 17 - 25 Fr.

Lithotripsy

◀ 24 - 25.5 Fr.



CYSTO-URETHROSCOPY & LITHOTRIPSY

► Schematic overview

CYSTO-URETHROSCOPY

Schematic overview CYSTO-URETHROSCOPY & LITHOTRIPSY: Systems and components for Ø 4.0 mm & 2.9 mm telescopes

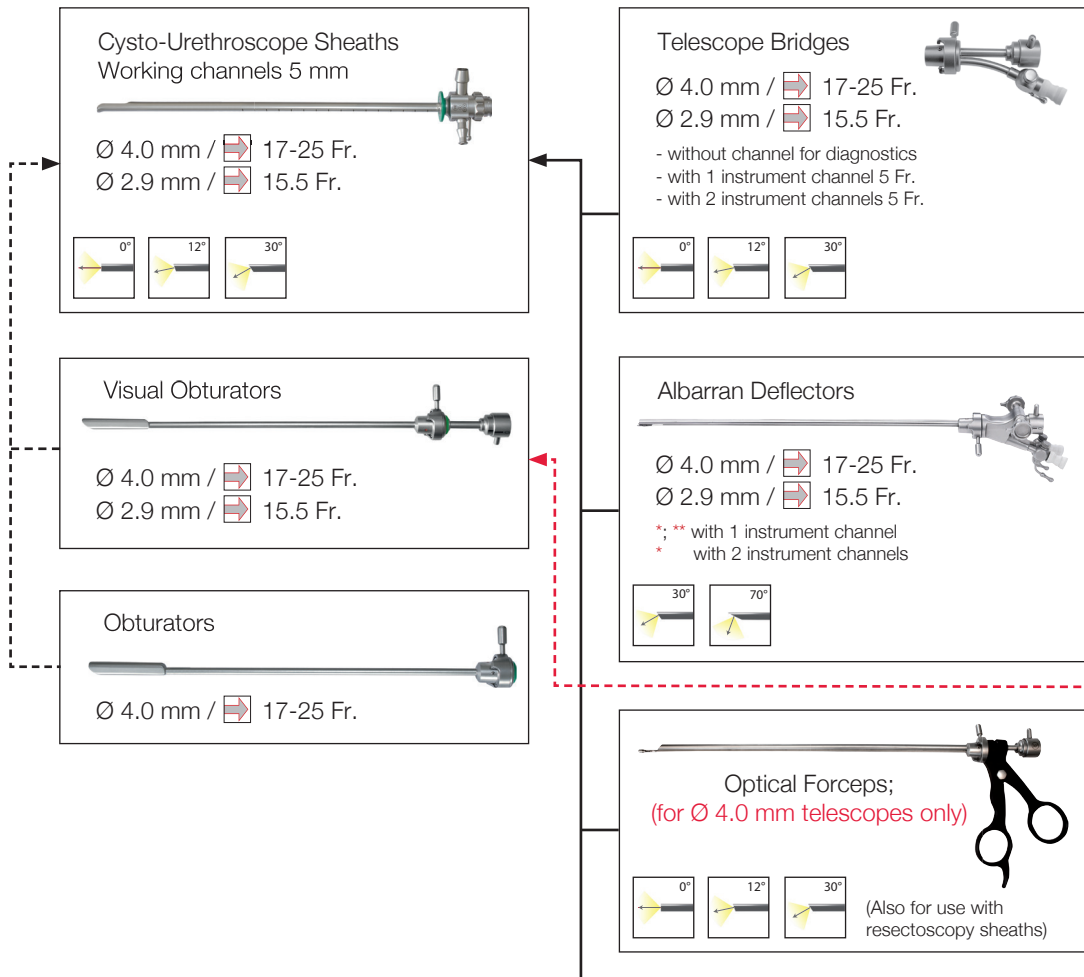

LITHOTRIPSY

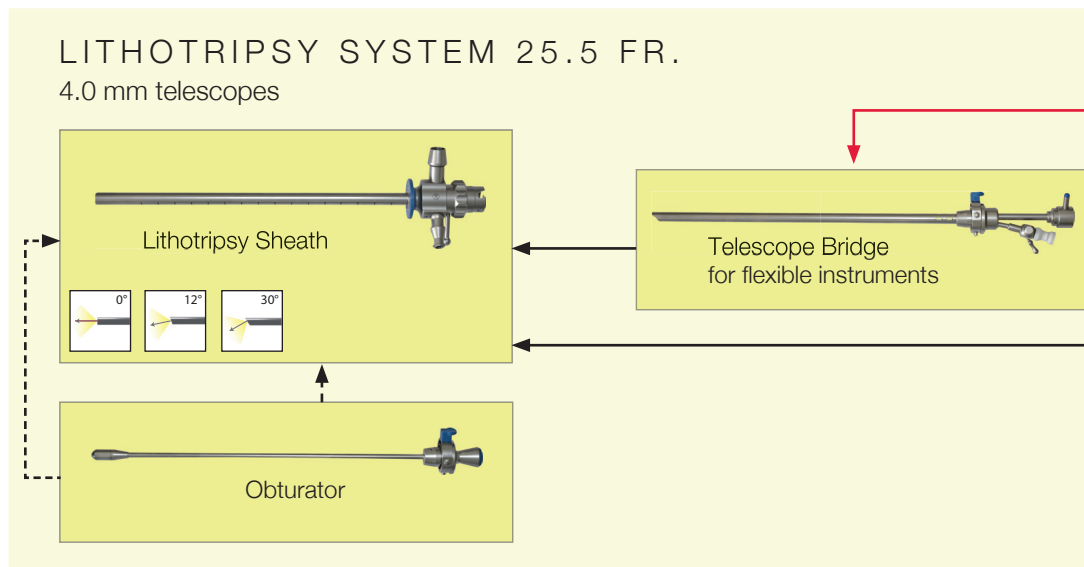



Systems and components for Ø 4.0 mm telescopes 17-25 Fr. & 25.5 Fr.
 Systems and components for Ø 2.9 mm telescopes 15 Fr.

15 Fr. Compact System;
 for Ø 2.9 mm telescopes
 with Standard Obturator

 Laser-Cystoscopy System 23 Fr.
 for Ø 4 mm telescopes

HF Flexible Electrodes
monopolar
 Sizes 3-7 Fr.

HF Semi-Flexible Electrodes **bipolar**
 Sizes 5 Fr.

HF Generator

Flexible Instruments;
 6 different inserts
FL 400 mm
 (Also for use with urethrotomes)

Telescopes Ø 4.0 mm / Ø 2.9 mm
 0°; 12°; 30°; 70°

HF Connection cables (2 types):

monopolar
 ----- to connect flexible **monopolar** HF electrodes to HF generator

bipolar
 ~~~~~ to connect semi-flexible **bipolar** HF electrodes to HF generator

Working Element for Punch Lithotripsy

Optical Stone Crushing Forceps  
 25 Fr.

(Also for use in resectoscopy sheaths)

Lithotripter 24 Fr.  
 (mechanical)

(only for use with 4 mm 70° telescope)



# CYSTO-URETHROSCOPY



TONTARRA's well assorted high quality Cystoscopy instrument product range is well known in the market. It has proven to meet the needs of surgeons all over the world.

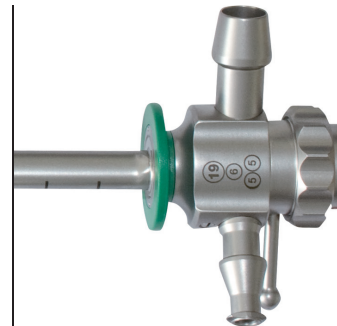

## TONTARRA'S PORTFOLIO INCLUDES

### FOR Ø 4.0 mm TELESCOPES:

- ▶ Cysto-Urethroscope systems in different sizes, including telescope bridges and Albarran deflector

- ▶ Optical forceps

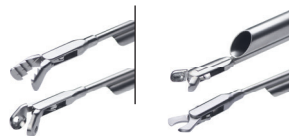

- ▶ 400 mm flexible instruments (5/7/9 Fr. working channels)

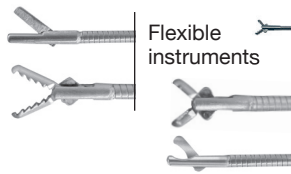

- ▶ Lithotripsy instruments (25.5 Fr. Lithotripsy system, stone crushing forceps, mechanical lithotriaptor)

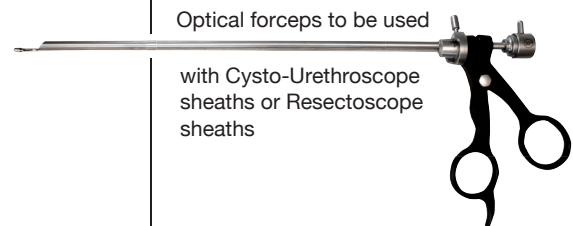

Optical forceps to be used

with Cysto-Urethroscope sheaths or Resectoscope sheaths

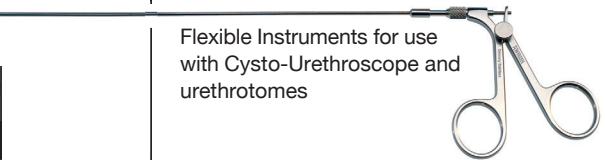

Flexible Instruments for use with Cysto-Urethroscope and urethrotomes



Lithotriaptor

- ▶ Laser Cystoscopy: see chapter "Laser instruments" 

### FOR Ø 2.9 mm TELESCOPES:

- ▶ Choose between a 15 Fr. compact system, or the 16 Fr. cysto-urethroscope system including telescope bridges and/or Albarran deflector (both options with 5 Fr. working channel)



Compact Cysto-Urethroscope

### Selection of Mono- and bipolar electrodes (3/5/7 Fr.)

Monopolar flexible HF electrodes



Bipolar semi-rigid HF electrodes

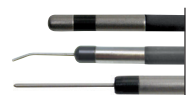

# CYSTO-URETHROSCOPY

- ▶ System for Ø 4.0 mm telescopes
- ▶ 17 - 25 Fr.

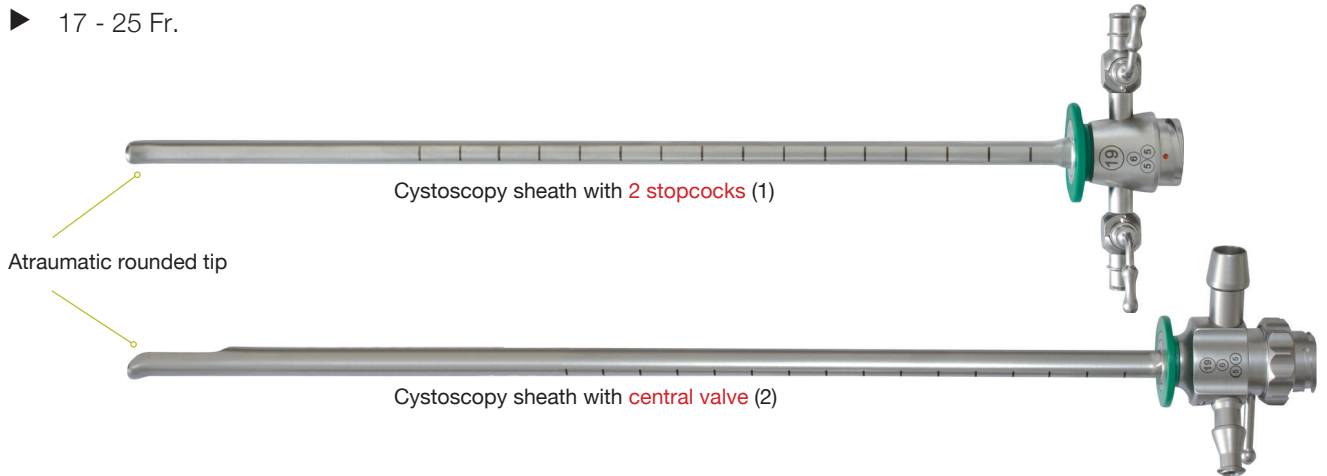

## CYSTO-URETHROSCOPE SHEATH SYSTEM for Ø 4 mm telescopes; without obturator

| Size and colour |          | 2 stopcocks (1) | 1 central valve (2) | Information |
|-----------------|----------|-----------------|---------------------|-------------|
| 17 Fr.          | ■ yellow | 630-012-17      | 630-017-17          |             |
| 19 Fr.          | ■ green  | 630-012-19      | 630-017-19          |             |
| 21 Fr.          | ■ red    | 630-012-21      | 630-017-21          |             |
| 23 Fr.          | ■ blue   | 630-012-23      | 630-017-23          |             |
| 25 Fr.          | □ white  | 630-012-25      | 630-017-25          |             |

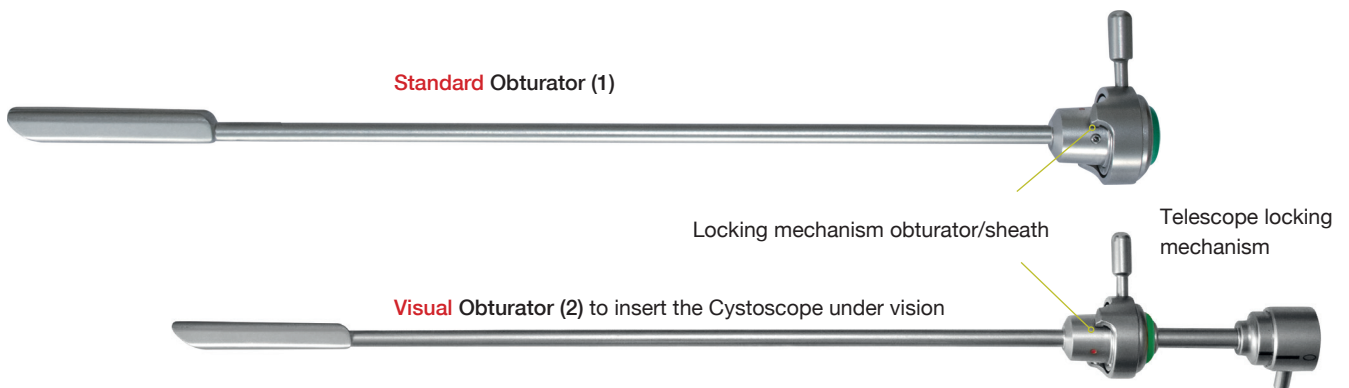

## OBTURATOR FOR CYSTO-URETHROSCOPE SHEATH SYSTEM for Ø 4 mm telescopes

| Size and colour |          | Standard (1) | Visual (2) | Information                   |
|-----------------|----------|--------------|------------|-------------------------------|
| 17 Fr.          | ■ yellow | 630-020-17   | 630-025-17 | 601-104-30HD<br>601-104-30HD2 |
| 19 Fr.          | ■ green  | 630-020-19   | 630-025-19 |                               |
| 21 Fr.          | ■ red    | 630-020-21   | 630-025-21 |                               |
| 23 Fr.          | ■ blue   | 630-020-23   | 630-025-23 |                               |
| 25 Fr.          | □ white  | 630-020-25   | 630-025-25 |                               |

# CYSTO-URETHROSCOPY

- ▶ System for Ø 4.0 mm telescopes
- ▶ 17 - 25 Fr.



## TELESCOPE BRIDGES FOR CYSTO-URETHROSCOPY ▶ 17-25 Fr.

|                                                                                                                                                                                                                                                                                                              |                                               |                                                |
|--------------------------------------------------------------------------------------------------------------------------------------------------------------------------------------------------------------------------------------------------------------------------------------------------------------|-----------------------------------------------|------------------------------------------------|
|                                                                                                                                                                                                                                                                                                              |                                               |                                                |
| TELESCOPE BRIDGE<br>for diagnostics only                                                                                                                                                                                                                                                                     | TELESCOPE BRIDGE<br>with 1 instrument channel | TELESCOPE BRIDGE<br>with 2 instrument channels |
| 630-030-00                                                                                                                                                                                                                                                                                                   | 630-030-01                                    | 630-030-02                                     |
| 601-104-30HD, 601-104-30HD2<br>For adaption to the Cystoscope sheath in order to use insert the Telescope. The working channel(s) not only support the use of flexible instruments and electrodes: Our models feature a very flat insertion angle, which also facilitates the use of semi-rigid instruments. |                                               |                                                |

## CYSTO-URETHROSCOPE SHEATHS in combination with Optical Bridges

| Size and colour |        | Channel size |
|-----------------|--------|--------------|
| 17 Fr.          | yellow | 1x 5 French  |
|                 |        | 2x 4 French  |
| 19 Fr.          | green  | 1x 6 French  |
|                 |        | 2x 5 French  |
| 21 Fr.          | red    | 1x 7 French  |
|                 |        | 2x 6 French  |
| 23 Fr.          | blue   | 1x 10 French |
|                 |        | 2x 7 French  |
| 25 Fr.          | white  | 1x 12 French |
|                 |        | 2x 8 French  |





# CYSTO-URETHROSCOPY

- ▶ System for Ø 4.0 mm telescopes
- ▶ 17 - 25 Fr.



## ALBARRAN DEFLECTOR

▶ 17-25 Fr.

| Description                                                                                                      | Art. No.   | Information                                                                                                                                                                                                                                    |
|------------------------------------------------------------------------------------------------------------------|------------|------------------------------------------------------------------------------------------------------------------------------------------------------------------------------------------------------------------------------------------------|
| with 1 instrument channel<br>  | 630-030-21 |  30° 601-104-30HD<br>601-104-30HD2<br> 70° 601-104-70HD<br>601-104-70HD2 |
| with 2 instrument channels<br> | 630-030-22 |                                                                                                                                                                                                                                                |



The Albarran deflecting mechanism enhances the control whilst positioning accessories (electrodes, flexible instruments, catheters). The Albarran lever can be locked at 5 different angles (up to 90°).

## CYSTO-URETHROSCOPE SHEATHS in combination with Albarran Deflector

| Size and colour |        | Channel size |
|-----------------|--------|--------------|
| 17 Fr.          | yellow | 1x 5 French  |
| 19 Fr.          | green  | 1x 5 French  |
|                 |        | 2x 4 French  |
| 21 Fr.          | red    | 1x 7 French  |
|                 |        | 2x 5 French  |
| 23 Fr.          | blue   | 1x 9 French  |
|                 |        | 2x 6 French  |
| 25 Fr.          | white  | 1x 10 French |
|                 |        | 2x 8 French  |



# CYSTO-URETHROSCOPY



- ▶ Optical instruments for Ø 4.0 mm telescopes
- ▶ 19 - 25 Fr.







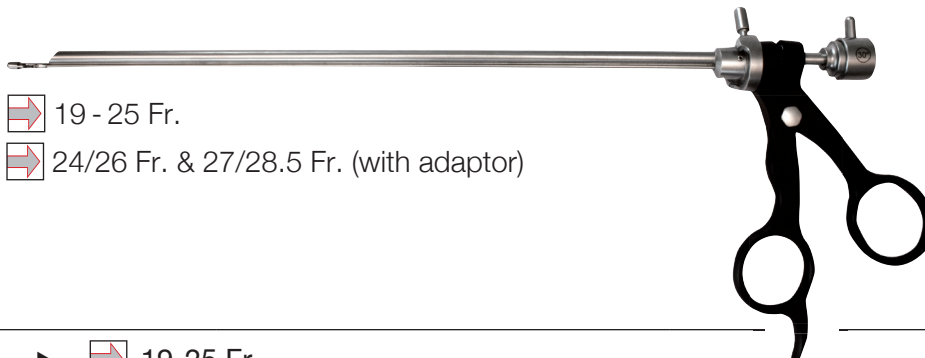





TONTARRA's optical instruments include scissors, forceps and punches for biopsy, foreign body extraction & removal of resectate. Extremely sharp cutting jaws, the stability of the entire instrument and an excellent flow rate enable the surgeon to safely perform mini-operations under vision right under the telescope objective.

FOR USE WITH:

- Cysto-Urethroscopes  19 - 25 Fr.
- Resectoscopy sheaths  24/26 Fr. & 27/28.5 Fr. (with adaptor)



**OPTICAL INSTRUMENTS** ▶  19-25 Fr.

| Description                                                            | Art. No.   |                                                                                      | Information                                                                                                                                                                                                                                |
|------------------------------------------------------------------------|------------|--------------------------------------------------------------------------------------|--------------------------------------------------------------------------------------------------------------------------------------------------------------------------------------------------------------------------------------------|
| GRASPING FORCEPS<br>▶ optical 0°/12°                                   | 630-035-00 |  |  601-104-00HD<br>601-104-00HD2                                                                                                                        |
| BIOPSY SPOON FORCEPS<br>▶ optical 0°/12°/30°                           | 630-035-05 |  |  601-104-12HD<br>601-104-12HD2                                                                                                                        |
| BIOPSY PUNCH<br>▶ optical 0°/12°                                       | 630-035-10 |  |  601-104-30HD<br>601-104-30HD2                                                                                                                        |
| HOOK SCISSORS<br>▶ optical 0°/12°                                      | 630-035-20 |  |                                                                                                                                                                                                                                            |
| BIOPSY PUNCH<br>▶ optical 12°/30°                                      | 630-035-13 |  |  601-104-12HD<br>601-104-12HD2<br> 601-104-30HD<br>601-104-30HD2 |
| BIOPSY SPOON FORCEPS<br>▶ optical 70°                                  | 630-035-15 |  |  601-104-70HD<br>601-104-70HD2                                                                                                                        |
| ADAPTOR<br>for use of optical instruments with<br>resectoscopy sheaths | 630-035-25 |  |                                                                                                                                                                                                                                            |



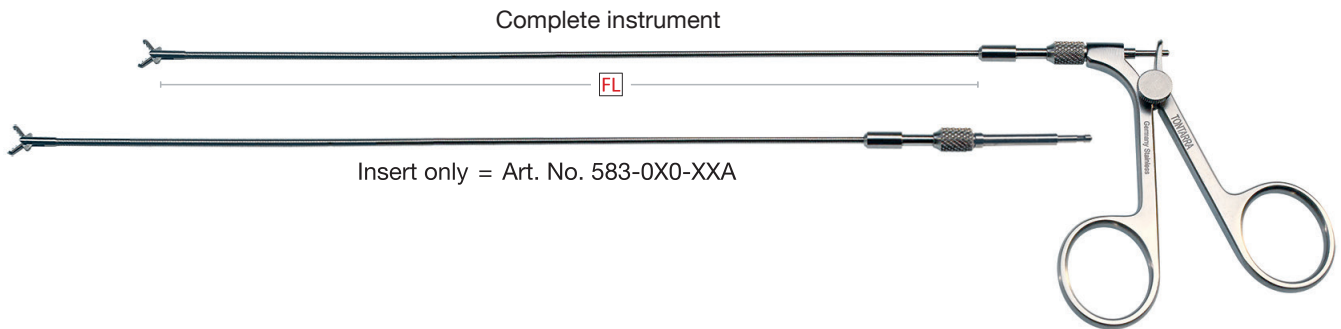

## FLEXIBLE INSTRUMENTS

- ▶ For Cysto-Urethrosopes and Urethrotomes
- ▶ Instrument channels 5 Fr./7 Fr./9 Fr.

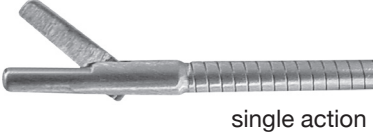
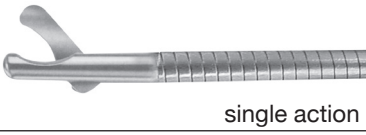

### FLEXIBLE INSTRUMENTS ▶ FL 400 mm

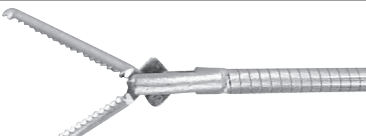





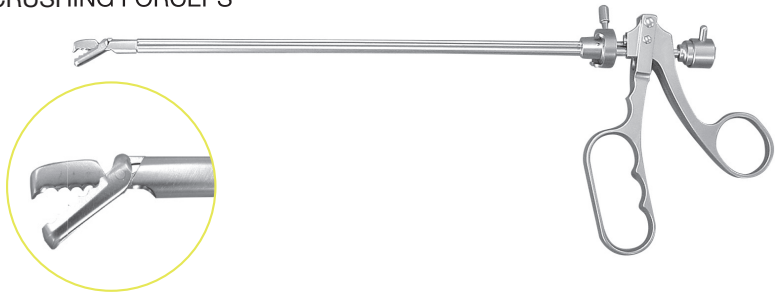

| Description                                                 | 5 Fr.       | 7 Fr.                                                                   | 9 Fr.       | Information                                                                                            |
|-------------------------------------------------------------|-------------|-------------------------------------------------------------------------|-------------|--------------------------------------------------------------------------------------------------------|
| BIOPSY FORCEPS<br>▶ flexible, oval, complete                | 583-010-16  | 583-010-23                                                              | 583-010-30  | <br>double action  |
| INSERT only                                                 | 583-010-16A | 583-010-23A                                                             | 583-010-30A |                                                                                                        |
| SCISSORS<br>▶ flexible, complete                            | 583-020-16  | 583-020-23                                                              | 583-020-30  | <br>single action |
| INSERT only                                                 | 583-020-16A | 583-020-23A                                                             | 583-020-30A |                                                                                                        |
| HOOK SCISSORS<br>▶ flexible, complete                       | 583-030-16  | 583-030-23                                                              | 583-030-30  | <br>single action |
| INSERT only                                                 | 583-030-16A | 583-030-23A                                                             | 583-030-30A |                                                                                                        |
| BIOPSY FORCEPS<br>▶ flexible, oval<br>▶ serrated, complete  | 583-050-16  | 583-050-23                                                              | 583-050-30  | <br>double action |
| INSERT only                                                 | 583-050-16A | 583-050-23A                                                             | 583-050-30A |                                                                                                        |
| GRASPING FORCEPS<br>▶ flexible, alligator jaw<br>▶ complete | 583-060-16  | 583-060-23                                                              | 583-060-30  | <br>double action |
| INSERT only                                                 | 583-060-16A | 583-060-23A                                                             | 583-060-30A |                                                                                                        |
| GRASPING FORCEPS<br>▶ flexible, serrated<br>▶ complete      | 583-070-16  |                                                                         |             | <br>double action |
| INSERT only                                                 | 583-070-16A |                                                                         |             |                                                                                                        |
| HANDLE only (spare part)                                    | 583-305-00  | for all urologic micro instruments 5/7/9 Fr. with Art. No's. 583-XXX-XX |             |                                                                                                        |

# LITHOTRIPSY



► Instruments for Ø 4 mm telescopes



## OPTICAL STONE CRUSHING FORCEPS ► 25 Fr.

| Description                                                                                                                                                                                                                                                                                                                                                                                                                                                                                                                                                                                                                     | Art. No.   | Information                                                                                                                                                                                                                                    |
|---------------------------------------------------------------------------------------------------------------------------------------------------------------------------------------------------------------------------------------------------------------------------------------------------------------------------------------------------------------------------------------------------------------------------------------------------------------------------------------------------------------------------------------------------------------------------------------------------------------------------------|------------|------------------------------------------------------------------------------------------------------------------------------------------------------------------------------------------------------------------------------------------------|
| <p>STONE CRUSHING FORCEPS</p>                                                                                                                                                                                                                                                                                                                                                                                                                                                                                                                 | 630-035-30 |  12° 601-104-12HD<br>601-104-12HD2<br> 30° 601-104-30HD<br>601-104-30HD2 |
| <p>ADAPTOR for using stone crushing forceps (No. 630-035-30) with 26/28.5 Fr. outer resectoscope sheath</p>                                                                                                                                                                                                                                                                                                                                                                                                                                    | 630-035-35 |                                                                                                                                                             |
| <p>For the lithotripsy of small stones, as well as an indispensable tool to split large stones to prepare the removal of larger stone fragments from the bladder through suction.</p> <p>TO USE WITH:</p> <ul style="list-style-type: none"> <li>· Cystoscopy sheaths  25 Fr.</li> <li>· Adapter to connect to resectoscopy outer sheaths  26 Fr.  28.5 Fr.</li> </ul> |            |                                                                                                                                                                                                                                                |

## LITHOTRIPTOR (mechanical) ► 24 Fr.











| Description                                                                                                                                                                                                                                                                                                             | Art. No.   | Information                                                                                                             |
|-------------------------------------------------------------------------------------------------------------------------------------------------------------------------------------------------------------------------------------------------------------------------------------------------------------------------|------------|-------------------------------------------------------------------------------------------------------------------------|
| <p>LITHOTRIPTOR</p> <ul style="list-style-type: none"> <li>► rotatable</li> <li>► 2 stopcocks</li> </ul>                                                                                                                            | 630-035-85 |  70° 601-104-70HD<br>601-104-70HD2 |
| <p>Two mechanisms, one instrument: Grasping and grinding of a stone is done with the lever handle mechanism. In case the manual force to split the stone is not sufficient, the mechanism of the spindle wheel will surely do so. Smaller stone residues can then easily be triturated again with the lever handle.</p> |            |                                                                                                                         |

# LITHOTRIPSY

▶ Instrument system for Ø 4 mm telescopes



## LITHOTRIPSY SYSTEM ▶ 25.5 Fr.

| Description                                                                                                                                                                                                                                                                                          | Art. No.   | Information                                                                                                                                                                                                                                 |
|------------------------------------------------------------------------------------------------------------------------------------------------------------------------------------------------------------------------------------------------------------------------------------------------------|------------|---------------------------------------------------------------------------------------------------------------------------------------------------------------------------------------------------------------------------------------------|
| <p>LITHOTRIPSY SHEATH WITH CENTRAL VALVE; 25.5 Fr. (without obturator)</p>                                                                                                                                          | 630-040-00 |                                                                                                                                                          |
| <p>STANDARD OBTURATOR</p> <p>▶ for lithotripsy sheath</p> <p>▶  25.5 Fr.</p>                                                       | 630-040-10 |                                                                                                                                                                                                                                             |
| <p>WORKING ELEMENT FOR PUNCH LITHOTRIPSY</p> <p>▶ optical</p> <p>▶  25.5 Fr.</p>                                                 | 630-040-05 |  601-104-12HD<br>601-104-12HD2<br><br> 601-103-30HD<br>601-103-30HD2 |
| <p>TELESCOPE BRIDGE FOR LITHOTRIPSY</p> <p>▶ 1 instrument channel 7 Fr.; only for flexible instruments</p> <p>▶  25.5 Fr.</p>  | 630-040-15 |                                                                                                                                                                                                                                             |

## CYSTO-URETHROSCOPY



- ▶ Systems for Ø 2.9 mm telescopes
- ▶ 15 Fr.



TONTARRA's 15 French cystoscopes for Ø 2.9 mm telescopes with a working length of 225 mm permit atraumatic diagnostics in adolescents and patients who require a very considerate intervention (f.e. delicate status of the lower urinal tract structures or general poor health conditions), or with extremely tight surroundings within the urogenital system. The sheath length permits to reach the proximal end of the urethra and into the bladder.

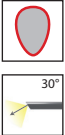

Our compact system works in combination with a 30° telescope, which allows thorough bladder inspections and biopsies (particularly within the base and posterior aspect of the bladder).

### CYSTO-URETHROSCOPY COMPACT SYSTEM ▶ 15 Fr.

| Description                                                                                                                                                                                                | Art. No.   | Information                                                                                        |
|------------------------------------------------------------------------------------------------------------------------------------------------------------------------------------------------------------|------------|----------------------------------------------------------------------------------------------------|
| <b>CYSTO-URETHROSCOPE SHEATH</b><br>▶ with 2 stopcocks<br>▶ integrated instrument channel 5 Fr. (without obturator)<br> | 630-042-01 |  601-103-30HD2 |
| <b>STANDARD OBTURATOR</b><br>                                                                                          | 630-042-02 |                                                                                                    |

The TONTARRA 16 Fr. cystoscopy system for Ø 2.9 mm telescopes with sheath, obturator, three different telescope bridges and Albarran deflector enables the use of telescopes with different angles (0° – 12° – 30° – 70°). Most frequently used and recommended are 30° and 70° telescopes.

### CYSTO-URETHROSCOPE SYSTEM ▶ 16 Fr.







| Description                                                                                                                                                           | Art. No.   | Information                                                                           |
|-----------------------------------------------------------------------------------------------------------------------------------------------------------------------|------------|---------------------------------------------------------------------------------------|
| <b>CYSTO-URETHROSCOPE SHEATH</b><br>▶ with 2 stopcocks<br>▶ without obturator<br> | 630-042-15 |  |
| <b>STANDARD OBTURATOR</b><br>                                                     | 630-042-20 |                                                                                       |

# CYSTO-URETHROSCOPY

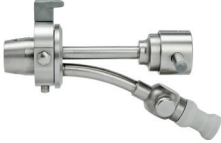
- ▶ Systems for  $\varnothing$  2.9 mm telescopes
- ▶ 16 Fr.



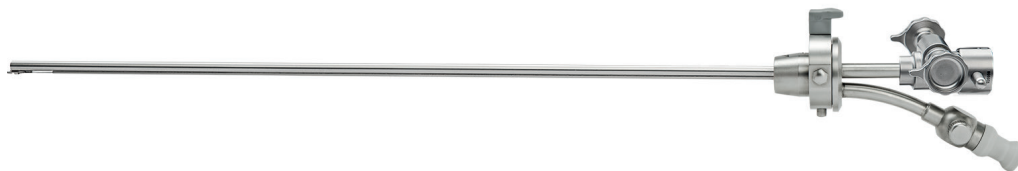

## TELESCOPE BRIDGES ▶ 16 Fr.

|                                                                                                                                                                                                                                                              |                                                                                                |                                                                                                                                                                                                |
|--------------------------------------------------------------------------------------------------------------------------------------------------------------------------------------------------------------------------------------------------------------|------------------------------------------------------------------------------------------------|------------------------------------------------------------------------------------------------------------------------------------------------------------------------------------------------|
|                                                                                                                                                                             |               |                                                                                                             |
| TELESCOPE BRIDGE for diagnostics only                                                                                                                                                                                                                        | TELESCOPE BRIDGE with 1 instrument channel 5 Fr.                                               | TELESCOPE BRIDGE with 2 instrument channels (1 x 5 Fr. or 2 x 3 Fr.)                                                                                                                           |
| 630-042-21                                                                                                                                                                                                                                                   | 630-042-22                                                                                     | 630-042-23                                                                                                                                                                                     |
|  601-103-12HD<br> 601-103-30HD2                                                            |  601-103-12HD |  601-103-30HD2  601-103-70 |
| For adaption of the cystoscope length to telescope length. The working channel(s) not only support the use of flexible instruments and electrodes: Our models feature a very flat insertion angle, which also facilitates the use of semi-rigid instruments. |                                                                                                |                                                                                                                                                                                                |



## ALBARRAN DEFLECTOR ▶ 16 Fr.

| Description                                                                                                                                                                                                                                                                                | Art. No.   | Information                                                                                                                                                                                             |
|--------------------------------------------------------------------------------------------------------------------------------------------------------------------------------------------------------------------------------------------------------------------------------------------|------------|---------------------------------------------------------------------------------------------------------------------------------------------------------------------------------------------------------|
| with 1 instrument channel 5 Fr.                                                                                                                                                                                                                                                            | 630-042-25 |  601-103-30HD2<br> 601-103-70 |
|  The Albarran deflecting mechanism enhances the control when positioning accessories (electrodes, flexible instruments, catheters). The Albarran lever can be locked at 5 different angles (up to 90°). |            |                                                                                                                                                                                                         |



## CYSTO-URETHROSCOPY



- ▶ Flexible electrodes for use with **monopolar** current and non-conductive solution (Sorbitol, Mannitol, Glycine); 3-7 Fr.
- ▶ Semi-flexible electrodes for use with **bipolar** current and conductive solution (NaCl 0.9%); 5 Fr.



### FLEXIBLE ELECTRODES; **MONOPOLAR** ▶ **FL** 470 mm

|              |  |  |  |
|--------------|-----------------------------------------------------------------------------------|------------------------------------------------------------------------------------|-------------------------------------------------------------------------------------|
| <b>Size</b>  | BUTTON ELECTRODE                                                                  | NEEDLE ELECTRODE, angled                                                           | LOOP ELECTRODE                                                                      |
| <b>3 Fr.</b> | 582-510-03                                                                        | -                                                                                  | -                                                                                   |
| <b>5 Fr.</b> | 582-510-05                                                                        | 582-511-05                                                                         | 582-514-05                                                                          |
| <b>7 Fr.</b> | 582-510-07                                                                        | 582-511-07                                                                         | 582-514-07                                                                          |

Other sizes (4 Fr./6 Fr./8 Fr./9 Fr.) are available on request

### HF CONNECTION CABLES; **MONOPOLAR** for working elements and flexible electrodes

| <b>Available for following units:</b>                       | <b>3.0 m</b> | Plug instrument side                                                                 |                                                                                       |
|-------------------------------------------------------------|--------------|--------------------------------------------------------------------------------------|---------------------------------------------------------------------------------------|
| Erbe/Storz Ø 5.0 mm                                         | 582-531-02   |  | For further information and pictures see overview of cables in chapter „Accessories”. |
| Valleylab, Conmed; Bowa Ø 8.0 mm                            | 582-532-03   |                                                                                      |                                                                                       |
| TONTARRA mod. PWT-400; Equipment with banana plug; Ø 4.0 mm | 582-533-04   |                                                                                      |                                                                                       |



### SEMI-FLEXIBLE ELECTRODES; **BIPOLAR** ▶ **FL** 360 mm Size 5 Fr.

|  |  |  |  |  |
|--|-------------------------------------------------------------------------------------|-------------------------------------------------------------------------------------|--------------------------------------------------------------------------------------|---------------------------------------------------------------------------------------|
|  | BUTTON ELECTRODE                                                                    | NEEDLE ELECTRODE angled 45°                                                         | NEEDLE ELECTRODE angled 90°                                                          | NEEDLE ELECTRODE straight                                                             |
|  | 582-515-05                                                                          | 582-516-05                                                                          | 582-518-05                                                                           | 582-517-05                                                                            |

### HF CONNECTION CABLES; **BIPOLAR** for semi-flexible electrodes with flat-cable plug

| <b>Available for following units:</b>    | <b>3.0 m</b> | <b>5.0 m</b> |                                                                                      |                                                                                       |
|------------------------------------------|--------------|--------------|--------------------------------------------------------------------------------------|---------------------------------------------------------------------------------------|
| Erbe; Storz/unit side round plug         | 287-200-30   | 287-200-50   |  | For further information and pictures see overview of cables in chapter „Accessories”. |
| Berchthold/ Martin/unit side round plug  | 287-205-30   | 287-205-50   |                                                                                      |                                                                                       |
| US-Models; 2-pins/unit side banana plugs | 287-210-30   | 287-210-50   |                                                                                      |                                                                                       |
| TONTARRA mod. PWT-400; Valleylab;        | 287-215-30   | 287-215-50   |                                                                                      |                                                                                       |
| International Models; 2 pins; Ø 4.0 mm   |              |              |                                                                                      |                                                                                       |



# RESECTOSCOPY

Ø 4 mm

◀ 24/26 Fr.

◀ 27/28.5 Fr.





**RESECTOSCOPY**

► Schematic overview

HYBRID RESECTOSCOPY > BOTH SYSTEMS < RESECTOSCOPY monopolar

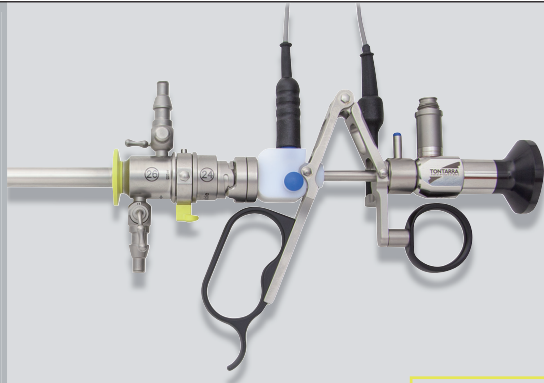

**HYBRID RESECTOSCOPY**

- for **monopolar** use or
- for **bipolar** use in saline solution NaCl 0.9 %

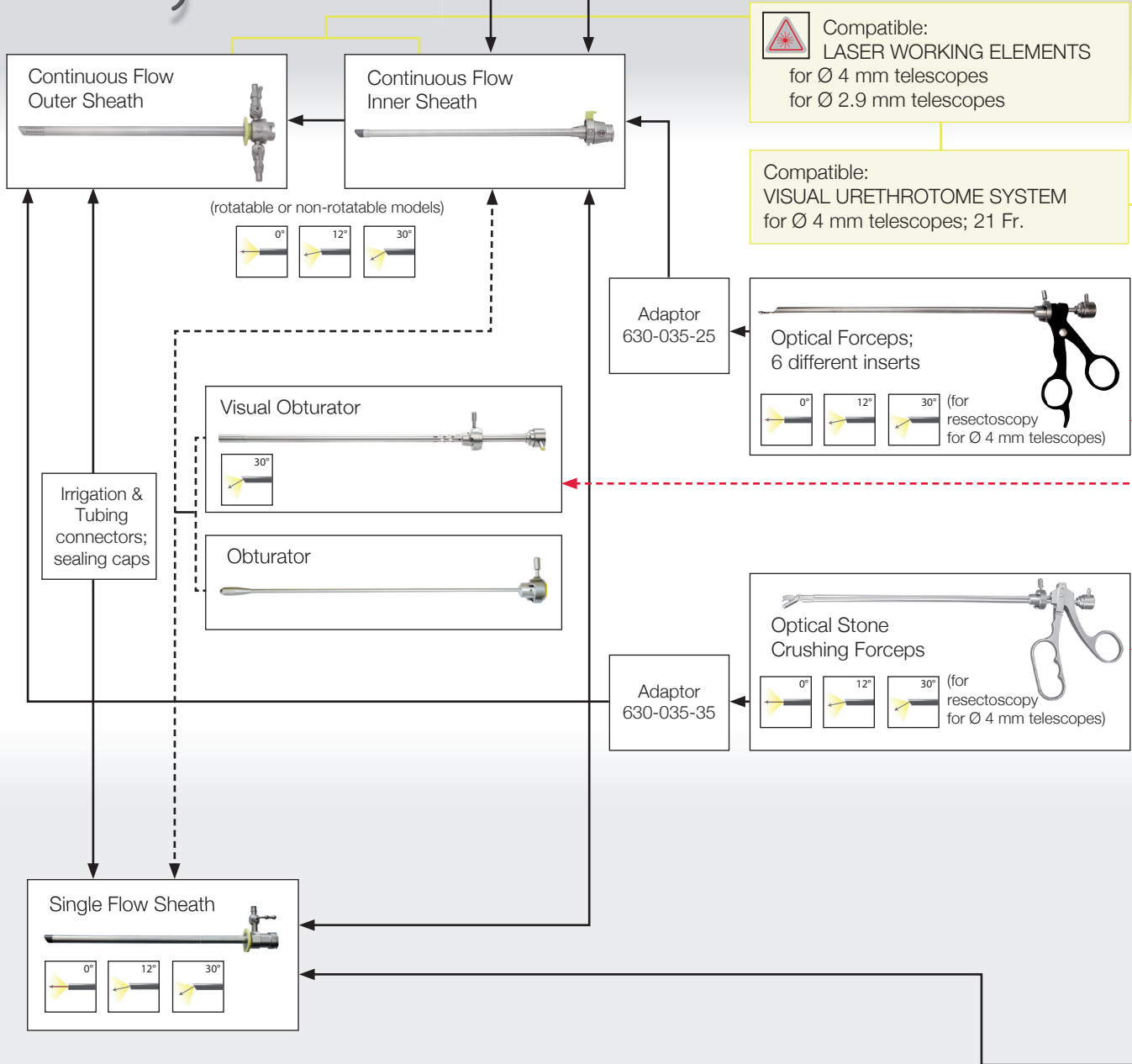

**RESECTOSCOPY** for **monopolar** use only



- 24/26 Fr.
- 27/28.5 Fr.
- 19/22 Fr.
- 17.5/18.5 Fr.

Systems and components for Ø 4.0 mm telescopes

Systems and components for Ø 2.9 mm telescopes

**MINI-CYSTO-RESECTOSCOPE**  
for Ø 2.9 mm telescopes  
for use with **bipolar** current  
in saline solution NaCl 0.9 %



17.5/18.5 Fr.

Electrodes **bipolar**  
(Reusable or SALINAE Single use)



(examples)

**Hybrid Working Element**  
(active or passive)

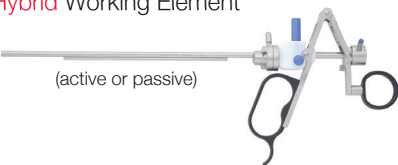

Telescopes Ø 4.0 / Ø 2.9 mm  
0°; 12°; 30°

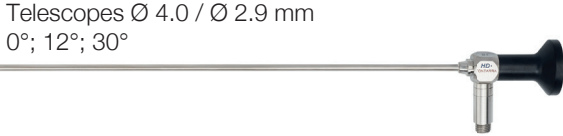

HF Connection cables (2 types):

**monopolar**  
to connect working element to HF generator

**bipolar**  
to connect working element to HF generator

HF Generator



Electrodes **monopolar**



(examples)

HF Needle electrodes **monopolar**  
(for resectoscopy for Ø 4 mm telescopes)



(examples)

**Working Element monopolar**  
(active or passive)

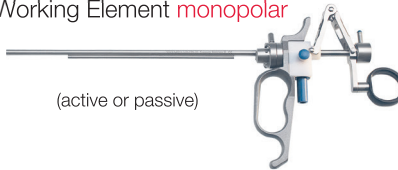

# RESECTOSCOPY

TONTARRA features an extensive modular resectoscopy system build around supreme quality resectoscopic sheaths in different sizes, several types of working elements, plus a wide range of electrodes for use with monopolar current, or bipolar current in saline solution (0.9 % NaCl).

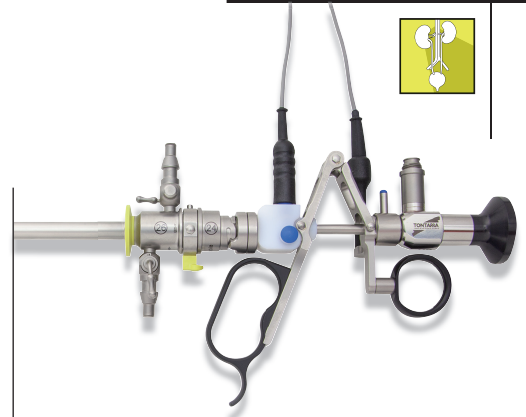

TONTARRA Hybrid Resectoscopy Systems respond to actual trends in contemporary urological resectoscopy.

## TONTARRA'S PORTFOLIO INCLUDES

### FOR Ø 4.0 mm TELESCOPES:

#### ► RESECTOSCOPY LINE 24/26 Fr.

- Continuous flow sheaths for mono- & bipolar use
- Single flow sheaths for monopolar use
- Hybrid Working elements for mono- or bipolar current, or working elements only for monopolar use; working elements for Gyrus electrodes
- Laser resectoscopy  (see chapter "Laser instruments")

#### ► RESECTOSCOPY LINE 27/28.5 Fr.

- Continuous flow sheaths for monopolar use
- Single flow sheaths for monopolar use
- Laser resectoscopy  (see chapter "Laser instruments")

#### ► COMPATIBLE MICRO TOOLS

- Optical forceps for telescopes Ø 4.0 mm
- Optical stone crushing forceps for use with resectoscopy outer sheath 26 & 28.5 Fr.

### FOR Ø 2.9 mm TELESCOPES:

#### ► RESECTOSCOPY LINE 19/22 Fr.

- Continuous flow sheaths for mono- & bipolar use
- Single flow sheaths for monopolar use
- Laser resectoscopy  (see chapter "Laser instruments")

#### ► MINI-RESECTOSCOPE 17.5/18.5 Fr.

- for bipolar use
- with separate working sheath
- Laser resectoscopy  (see chapter "Laser instruments")

The tendency clearly goes towards the use of bipolar current with saline solution (0.9 % NaCl) as distension medium thanks to several advantages:

- less risk of hyponatremia and hypervolemia
  - less distension volume/less strain on the tissue
  - lower work temperature on tissue during surgery which results in less necrosis around the treated areas
- Reusable mono- & bipolar electrodes and bipolar **single use** electrodes (Salinæ)

17.5/18.5 Fr. 19/22 Fr. 24/26 Fr. 27/28 Fr.

#### Monopolar electrodes



#### Bipolar electrodes



#### Monopolar HF-needle electrodes

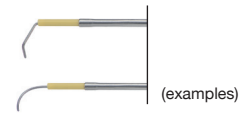

#### 19/22 Fr: TONTARRA's „White Line“

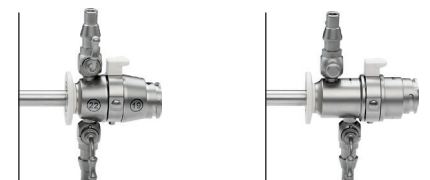

A further miniaturization of instruments in Urology is reflected by TONTARRA's 19/22 Fr. resectoscopy system for Ø 2.9 mm telescopes. The loops are optimally designed for lower impact and patient-friendly interventions, which lead to a faster healing process for the patient and cost reduction for health care systems.

# RESECTOSCOPY SYSTEM FOR Ø 4.0 mm TELESCOPES

- ▶ HYBRID HF working elements 24/26 Fr.



24/26 Fr.

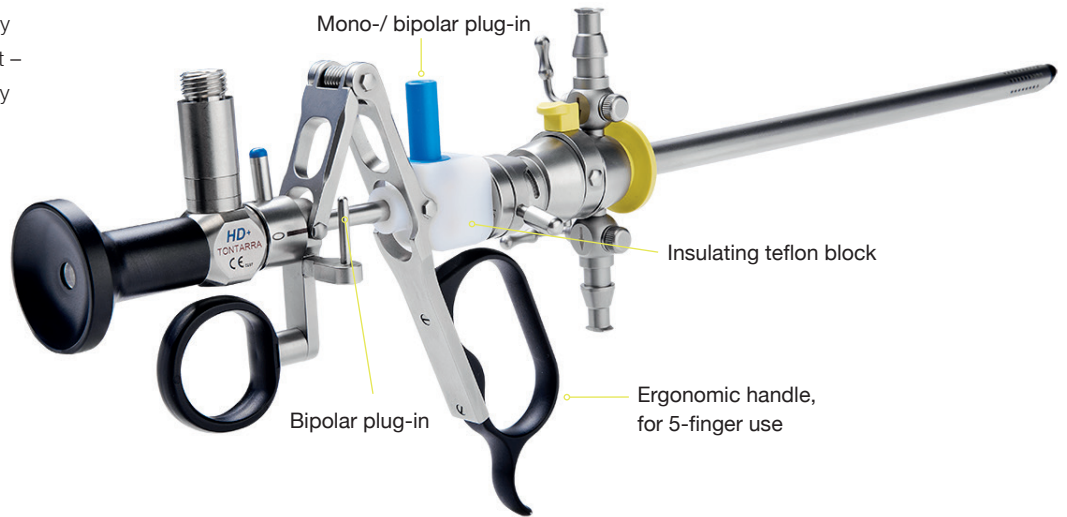

Hybrid Resectoscopes facilitate the gradual integration of new procedures into clinics, and provide the freedom of choice to either proceed working with monopolar distension mediums, or to gradually change procedures to the use of bipolar current in saline solution.

A light-weight and extremely ergonomic working element – made with sections of highly resistant titanium.



## HYBRID HF WORKING ELEMENTS; closed handle

- ▶ For use with electrodes in **monopolar** current mode and non-conductive solution (e.G. Sorbitol, Mannitol, Glycine)
- ▶ For use with electrodes in **bipolar** current mode and conductive solution (physiologic saline solution, NaCl 0.9 %)

| Description                                                                                                                                                                                      | Art. No.      | HF-Connection |
|--------------------------------------------------------------------------------------------------------------------------------------------------------------------------------------------------|---------------|---------------|
| WORKING ELEMENT;<br>active<br>                                                                                | 630-235-10B   | upwards       |
| WORKING ELEMENT;<br>passive*<br>                                                                              | 630-235-60B   | upwards       |
| SAFETY DISTANCE HOLDER<br>for bipolar working element 630-235-10B;<br>635-235-60B (2.0 mm width)<br>1 pc.<br> | 582-150-02GUB | –             |

\*Also for use in urethrotomy

# RESECTOSCOPY SYSTEM FOR Ø 4.0 mm TELESCOPES

► HYBRID continuous flow sheaths for **mono-** & **bipolar** use



■ 24/26 Fr.

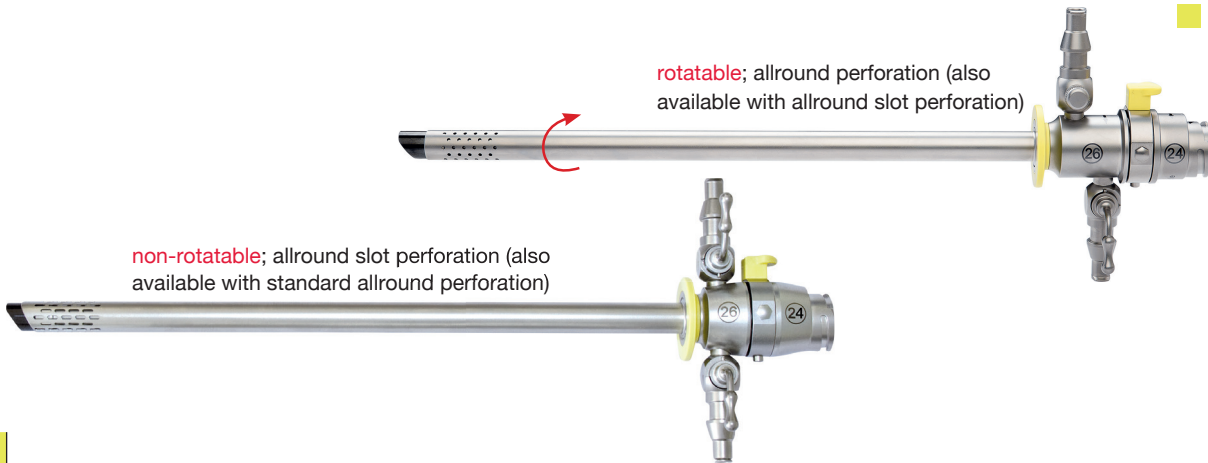

CONTINUOUS FLOW SHEATHS; 2 stopcocks; without obturator ► ■ yellow



| Description                                                                                                  | Allround perforation           | Slot perforation               |
|--------------------------------------------------------------------------------------------------------------|--------------------------------|--------------------------------|
| The continuous flow sheaths are available with allround- or slot perforation (see the pictures to the right) |                                |                                |
| <b>non-rotatable</b>                                                                                         |                                |                                |
| <b>OUTER SHEATH</b><br>► 26 Fr.<br>► 2 stopcocks<br>                                                         | 630-204-06                     | 630-204-07                     |
| <b>INNER SHEATH</b><br>► 24/26 Fr.<br>                                                                       | 630-204-26                     | 630-204-26                     |
| <b>rotatable</b>                                                                                             |                                |                                |
| <b>OUTER SHEATH</b><br>► 26 Fr.<br>► 2 stopcocks<br>                                                         | 630-209-06                     | 630-209-07                     |
| <b>INNER SHEATH</b><br>► 24/26 Fr.<br>                                                                       | 630-209-26                     | 630-209-26                     |
| 601-104-00HD;<br>601-104-00HD2                                                                               | 601-104-12HD;<br>601-104-12HD2 | 601-104-30HD;<br>601-104-30HD2 |

Compatible to Laser working elements and accessories: see chapter „Laser instruments“

# RESECTOSCOPY SYSTEM FOR Ø 4.0 mm TELESCOPES







► Obturators & adaptor

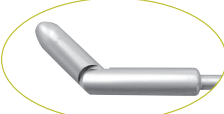

24/26 Fr.

## OBTURATORS; ADAPTOR

24/26 Fr.

| Description                                                                                                                                              | yellow     | Information                                                                                                              |
|----------------------------------------------------------------------------------------------------------------------------------------------------------|------------|--------------------------------------------------------------------------------------------------------------------------|
| STANDARD OBTURATOR<br>                                                 | 630-215-24 |                                                                                                                          |
| DEFLECTING TIP OBTURATOR<br>                                           | 630-220-24 |                                       |
| VISUAL OBTURATOR<br>                                                   | 630-225-24 |  30°<br>601-104-30HD<br>601-104-30HD2 |
| VISUAL OBTURATOR with 1 instrument channel 5 Fr.<br>                  | 630-230-24 |                                                                                                                          |
| ADAPTOR for use of optical instruments with resectoscopy sheaths<br> | 630-035-25 |                                                                                                                          |

## MICRO TOOLS COMPATIBLE TO THE 24/26 FR. RESECTOSCOPY SYSTEM

► Optical forceps:



ADAPTOR for using optical instruments with resectoscopy sheaths

24/26 Fr. & 27/28.5 Fr.

(Art. No. 630-035-25)

► Stone crushing forceps:

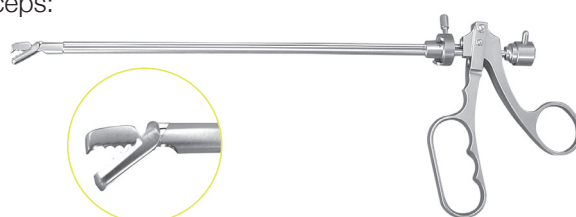

ADAPTOR for using stone crushing forceps with resectoscopic outer sheaths

26 Fr. & 28.5 Fr.

(Art. No. 630-035-35)

## RESECTOSCOPY SYSTEM FOR Ø 4.0 mm TELESCOPES

- ▶ Reusable electrodes for use with **bipolar** current and conductive solution (NaCl 0.9 %)
- ▶ SALINÆ disposable electrodes for use with **bipolar** current and conductive solution (NaCl 0.9 %)



24/26 Fr.

### BIPOLAR ELECTRODES; reusable or single use

24/26 Fr.

| Description                                  | Colour code | Reusable      | SALINÆ Single use electrodes* |  |
|----------------------------------------------|-------------|---------------|-------------------------------|--|
| LOOP ELECTRODE; angled; 30°                  | yellow/blue | 630-240-00B   | 630-240-00B-S                 |  |
| PI CUT LOOP ELECTRODE; for high temperatures | yellow/blue | 630-240-00BPI | -                             |  |
| LOOP ELECTRODE                               | yellow/blue | 630-240-05B   | -                             |  |
| LOOP ELECTRODE; straight                     | yellow/blue | 630-240-10B   | 630-240-10B-S                 |  |
| BALL ELECTRODE; Ø 3 mm                       | yellow/blue | 630-240-15B   | 630-240-15B-S                 |  |
| BALL ELECTRODE; Ø 5 mm                       | yellow/blue | 630-240-20B   | -                             |  |
| ROLLER ELECTRODE; Ø 3 mm                     | yellow/blue | 630-240-25B   | -                             |  |
| ROLLER ELECTRODE; Ø 5 mm                     | yellow/blue | 630-240-30B   | -                             |  |
| CONICAL ELECTRODE                            | yellow/blue | 630-240-35B   | -                             |  |
| KNIFE ELECTRODE                              | yellow/blue | 630-240-40B   | 630-240-40B-S                 |  |

\* Sterile, single packaged; 5 pcs./box

For cable connection see cable overview

RESECTOSCOPY SYSTEM FOR Ø 4.0 mm TELESCOPES

- ▶ Reusable electrodes for use with **bipolar** current and conductive solution (NaCl 0.9 %)



■ 24/26 Fr.

**BIPOLAR ELECTRODES; reusable**

➡ 24/26 Fr.

| Description                             | Colour code   | Reusable    | SALINÆ Single use electrodes |  |
|-----------------------------------------|---------------|-------------|------------------------------|--|
| VAPORIZATION ELECTRODE; Ø 3 mm; toothed | ■ yellow/blue | 630-240-45B | –                            |  |
| VAPORIZATION ELECTRODE; Ø 3 mm; smooth  | ■ yellow/blue | 630-240-55B | –                            |  |
| VAPORIZATION ELECTRODE; Ø 5 mm; smooth  | ■ yellow/blue | 630-240-60B | –                            |  |
| VAPORIZATION ELECTRODE; cone shaped     | ■ yellow/blue | 630-240-75B | –                            |  |

For cable connection see cable overview in „Accessories“

RESECTOSCOPY SYSTEM FOR Ø 4.0 mm TELESCOPES

- ▶ Working elements; **monopolar**
- ▶ Single flow sheaths



- 24/26 Fr.
- 27/28.5 Fr.

**MONOPOLAR HF WORKING ELEMENTS; closed handles**

| Description                 | Art. No.   | HF-Connection |  |
|-----------------------------|------------|---------------|--|
| WORKING ELEMENT;<br>active  | 630-235-10 | downwards     |  |
| WORKING ELEMENT;<br>passive | 630-235-60 | downwards     |  |
| WORKING ELEMENT;<br>active  | 630-235-11 | upwards       |  |
| WORKING ELEMENT;<br>passive | 630-235-61 | upwards       |  |

**SINGLE FLOW SHEATHS; 24 Fr. (for monopolar use only)**

| Size                                  | Colour Code | Art. No.   | Information |
|---------------------------------------|-------------|------------|-------------|
| SINGLE FLOW SHEATH with 1 stopcock    | ■ yellow    | 630-200-24 |             |
| SINGLE FLOW SHEATH with central valve |             | 630-202-24 |             |



# RESECTOSCOPY SYSTEM FOR Ø 4.0 mm TELESCOPES

- ▶ Reusable electrodes for use with **monopolar** current and non-conductive solution (Sorbitol, Mannitol, Glycine)



■ 24/26 Fr.

## MONOPOLAR HF ELECTRODES

➡ 24/26 Fr.

| ➡ 24/26 Fr.                        | Colour code | Art. No.   | Electrode Spez. |  |
|------------------------------------|-------------|------------|-----------------|--|
| LOOP ELECTRODE;<br>angled 30°      | ■ yellow    | 630-240-00 | 30°             |  |
| LOOP ELECTRODE;<br>angled 12°      | ■ blue      | 630-240-05 | -               |  |
| LOOP ELECTRODE;<br>straight        | ■ yellow    | 630-240-10 |                 |  |
| BALL ELECTRODE                     | ■ yellow    | 630-240-15 | Ø 3.0 mm        |  |
|                                    | ■ yellow    | 630-240-20 | Ø 5.0 mm        |  |
| ROLLER ELECTRODE                   | ■ yellow    | 630-240-25 | Ø 3.0 mm        |  |
|                                    | ■ yellow    | 630-240-30 | Ø 5.0 mm        |  |
| CONICAL ELECTRODE                  | ■ yellow    | 630-240-35 |                 |  |
| KNIFE ELECTRODE;<br>angled         | ■ yellow    | 630-240-40 |                 |  |
| VAPORIZATION ELECTRODE;<br>toothed | ■ yellow    | 630-240-45 | Ø 3.0 mm        |  |
|                                    | ■ yellow    | 630-240-50 | Ø 5.0 mm        |  |
| VAPORIZATION ELECTRODE;<br>smooth  | ■ yellow    | 630-240-55 | Ø 3.0 mm        |  |
|                                    | ■ yellow    | 630-240-60 | Ø 5.0 mm        |  |
| BAND ELECTRODE;<br>angled          | ■ yellow    | 630-240-65 | 30°             |  |
|                                    | ■ yellow    | 630-240-70 | 0°/12°          |  |

## RESECTOSCOPY SYSTEM FOR Ø 4.0 mm TELESCOPES

- ▶ HF-Needle electrodes for papillary bladder tumor resection
- ▶ Reusable electrodes for use with **monopolar** current and non-conductive solution (Sorbitol, Mannitol, Glycine)





24/26 Fr.



### HF-NEEDLE ELECTRODES for papillary bladder tumor resection; **monopolar**

24/26 Fr.

| 24/26 Fr.                                                                         | Art. No.   | Electrode Spez.                                                                    |            |
|-----------------------------------------------------------------------------------|------------|------------------------------------------------------------------------------------|------------|
| HF-NEEDLE ELECTRODE; angled; <b>left</b> ; 24/26 Fr.                              | 630-240-90 | HF-NEEDLE ELECTRODE; angled; <b>right</b> ; 24/26 Fr.                              | 630-240-95 |
|  |            |  |            |

For the resection of papillary tumors in one piece. The two different forms of the loops enable the tumor resection from different locations of the bladder wall.

### HF CONNECTION CABLES; **MONOPOLAR** for semi-flexible electrodes / for working elements

|                                                                                                                                            |                                                        |                                                                                      |                                                                                       |
|--------------------------------------------------------------------------------------------------------------------------------------------|--------------------------------------------------------|--------------------------------------------------------------------------------------|---------------------------------------------------------------------------------------|
| <b>Available for following units:</b><br>Erbe/Storz; Ø 5.0 mm<br>Valleylab; Conmed; Bowa; Ø 8.0 mm<br>Equipment with banana plug; Ø 4.0 mm | <b>3.0 m</b><br>582-531-02<br>582-532-03<br>582-533-04 |  | For further information and pictures see overview of cables in chapter „Accessories“. |
|--------------------------------------------------------------------------------------------------------------------------------------------|--------------------------------------------------------|--------------------------------------------------------------------------------------|---------------------------------------------------------------------------------------|

# RESECTOSCOPY SYSTEM FOR Ø 4.0 mm TELESCOPES



- ▶ HYBRID continuous flow sheaths for **mono-** & **bipolar** use
- ▶ Obturators & adaptor



■ 27/28.5 Fr.

## CONTINUOUS FLOW SHEATHS; 2 stopcocks

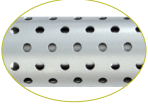
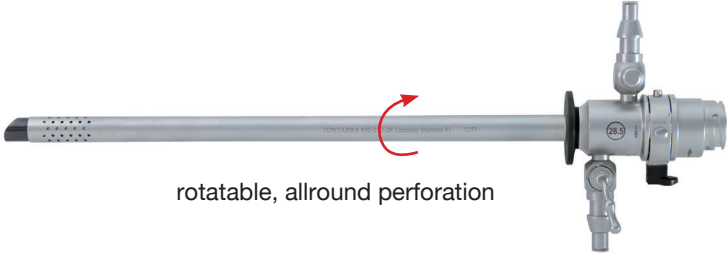



| Description                                                                                                                                                                                                 | Allround perforation                                                                                                           |            |
|-------------------------------------------------------------------------------------------------------------------------------------------------------------------------------------------------------------|--------------------------------------------------------------------------------------------------------------------------------|------------|
|   <p>rotatable, allround perforation</p> |  <p>non-rotatable, allround perforation</p> |            |
|                                                                                                                                                                                                             | Non-rotatable                                                                                                                  | Rotatable  |
| OUTER SHEATH (28.5 Fr.)                                                                                                                                                                                     | 630-204-08                                                                                                                     | 630-209-08 |
| INNER SHEATH (27 Fr.)                                                                                                                                                                                       | 630-204-28                                                                                                                     | 630-209-28 |

 Compatible to Laser working elements and accessories: see chapter „Laser instruments“

All mono- and bipolar electrodes for the 24/26 Fr. resectoscopy system can also be used with the 27/28.5 Fr. system.  
For monopolar electrodes 27/28.5 Fr. see next page

## OBTURATORS; ADAPTOR

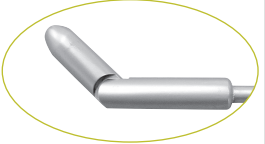
 27/28.5 Fr.

| Description                                                      | Art. No.   | Information                                                                                                                |
|------------------------------------------------------------------|------------|----------------------------------------------------------------------------------------------------------------------------|
| STANDARD OBTURATOR                                               | 630-215-27 |                                                                                                                            |
| DEFLECTING TIP OBTURATOR                                         | 630-220-27 |                                       |
| VISUAL OBTURATOR                                                 | 630-225-27 |  30°<br>601-104-30HD<br>601-104-30HD2 |
| VISUAL OBTURATOR with 1 instrument channel 7 Fr.                 | 630-230-27 |                                                                                                                            |
| ADAPTOR for use of optical instruments with resectoscopy sheaths | 630-035-25 |                                                                                                                            |

## RESECTOSCOPY SYSTEM FOR Ø 4.0 mm TELESCOPES



- ▶ Single flow sheaths for **monopolar** use
- ▶ Reusable electrodes for use with **monopolar** current and non-conductive solution (Sorbitol, Mannitol, Glycine)



■ 27/28.5 Fr.





### SINGLE FLOW SHEATHS (for monopolar use only)



| Description                                                                        | Art. No.   |
|------------------------------------------------------------------------------------|------------|
| SINGLE FLOW SHEATH with 1 stopcock; 27 Fr.                                         | 630-200-27 |
|  |            |
| SINGLE FLOW SHEATH with central valve; 27 Fr.                                      | 630-202-27 |
|  |            |

### MONOPOLAR ELECTRODES

⇒ 27/28.5 Fr.

| ⇒ 27/28.5 Fr.                                                                                                | Colour code | Art. No.   | Electrode Spec. |                                                                                       |
|--------------------------------------------------------------------------------------------------------------|-------------|------------|-----------------|---------------------------------------------------------------------------------------|
| LOOP ELECTRODE;<br>angled                                                                                    | ■ brown     | 630-240-01 | 30 °            |  |
|                                                                                                              | ■ brown     | 630-240-06 | 12 °            |  |
| LOOP ELECTRODE;<br>straight                                                                                  | ■ brown     | 630-240-11 |                 |  |
| KNIFE ELECTRODE;<br>angled                                                                                   | ■ brown     | 630-240-41 |                 |  |
| Monopolar electrodes for 24/26 Fr. resectoscopes can also be used with TONTARRA's 27/28.5 Fr. resectoscopes. |             |            |                 |                                                                                       |

### HF CONNECTION CABLES; **MONOPOLAR** for working elements and flexible electrodes

|                                                                                                                                                                   |                                                        |                                                                                      |                                                                                       |
|-------------------------------------------------------------------------------------------------------------------------------------------------------------------|--------------------------------------------------------|--------------------------------------------------------------------------------------|---------------------------------------------------------------------------------------|
| <b>Available for following units:</b><br>Erbe/Storz; Ø 5.0 mm<br>Valleylab; Conmed; Bowa; Ø 8.0 mm<br>TONTARRA mod. PWT-400; Equipment with banana plug; Ø 4.0 mm | <b>3.0 m</b><br>582-531-02<br>582-532-03<br>582-533-04 |  | For further information and pictures see overview of cables in chapter „Accessories”. |
|-------------------------------------------------------------------------------------------------------------------------------------------------------------------|--------------------------------------------------------|--------------------------------------------------------------------------------------|---------------------------------------------------------------------------------------|

MICRO TOOLS COMPATIBLE TO THE 27/28.5 Fr.  
RESECTOSCOPY SYSTEM



■ 27/28.5 Fr.

► Optical forceps "Drop Style" for better insertion:

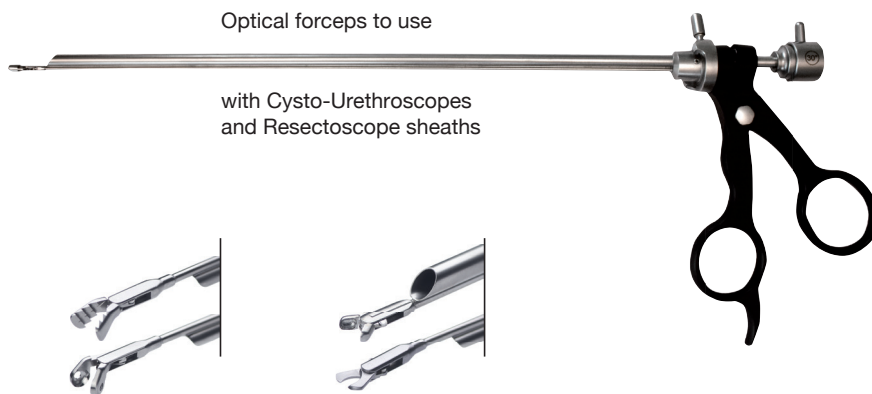

ADAPTOR for use of optical instru-  
ments with resectoscopy sheaths

➔ 24/26 Fr. & 27/28.5 Fr.

(Art. No. 630-035-25)

► Stone crushing forceps:

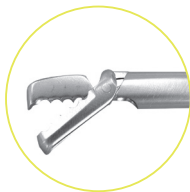

ADAPTOR for using stone crushing  
forceps with resectoscopic outer  
sheaths

➔ 26 Fr. & 28.5 Fr.

(Art. No. 630-035-35)

## RESECTOSCOPY SYSTEM FOR Ø 4.0 mm TELESCOPES



- ▶ Working elements for Ø 4.0 mm telescopes
- ▶ To use with **bipolar** Gyrus electrodes and Gyrus generator (from company Olympus/Gyrus)

### WORKING ELEMENT TO USE WITH GYRUS ELECTRODES; **BIPOLAR**

- ▶ Titanium; closed handle

| Compatibility   | Active cutting | Passive cutting | Conus      |  |
|-----------------|----------------|-----------------|------------|--|
| GYRUS / Storz   | 630-350-05     | 630-350-55      | 2 included |  |
| extra conus     |                |                 | 630-350-90 |  |
| GYRUS / Wolf    | 630-351-05     | 630-351-55      | 1 included |  |
| extra conus     |                |                 | 630-351-90 |  |
| GYRUS / Olympus | 630-352-05     | 630-352-55      | 1 included |  |
| extra conus     |                |                 | 630-352-90 |  |



# RESECTOSCOPY

Ø 2.9 mm

◀ 19/22 Fr.



# RESECTOSCOPY SYSTEM FOR Ø 2.9 mm TELESCOPES





- ▶ Working elements (**hybrid** or **monopolar**) for Ø 2.9 mm telescopes

## HYBRID WORKING ELEMENTS; closed handles

- ▶ For use with electrodes in **monopolar** current mode and non-conductive solution (e.G. Sorbitol, Mannitol, Glycine)
- ▶ For use with electrodes in **bipolar** current mode and conductive solution (physiologic saline solution, NaCl 0.9 %)

| Description                               | Art. No.    | HF-Connection |                                                                                     |
|-------------------------------------------|-------------|---------------|-------------------------------------------------------------------------------------|
| HYBRID WORKING ELEMENT;<br><b>active</b>  | 630-335-10B | upwards       |   |
| HYBRID WORKING ELEMENT;<br><b>passive</b> | 630-335-60B | upwards       |  |

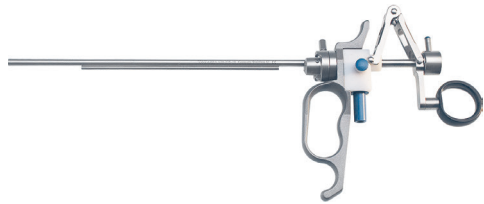
## WORKING ELEMENTS FOR **MONOPOLAR** USE; closed handles

| Description                         | Art. No.   | HF-Connection |                                                                                       |
|-------------------------------------|------------|---------------|---------------------------------------------------------------------------------------|
| WORKING ELEMENT;<br><b>active</b>   | 630-335-10 | downwards     |   |
| WORKING ELEMENT;<br><b>passive*</b> | 630-335-60 | downwards     |  |

\*Also for use in urethrotomy



# RESECTOSCOPY SYSTEM FOR Ø 2.9 mm TELESCOPES

- ▶ Resectoscopy sheaths for **mono & bipolar** use
- ▶ Obturators



19/22 Fr.

## HYBRID CONTINUOUS FLOW SHEATHS; 2 stopcocks

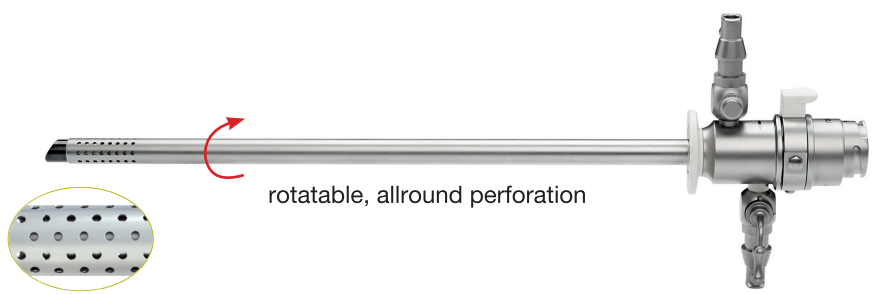
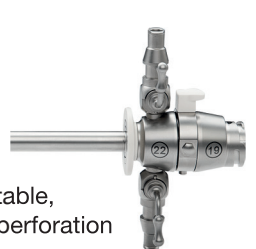

| Description                                                                                                               | Allround perforation                                                                                                           |            |
|---------------------------------------------------------------------------------------------------------------------------|--------------------------------------------------------------------------------------------------------------------------------|------------|
|  <p>rotatable, allround perforation</p> |  <p>non-rotatable, allround perforation</p> |            |
|                                                                                                                           | Non-rotatable                                                                                                                  | Rotatable  |
| OUTER SHEATH; 22 Fr.                                                                                                      | 630-304-01                                                                                                                     | 630-309-01 |
| INNER SHEATH; 19 Fr.                                                                                                      | 630-304-21                                                                                                                     | 630-309-21 |

 Compatible to Laser working elements and accessories: see chapter „Laser instruments“

## SINGLE-FLOW SHEATH (for monopolar use only)

| Description                                                                                                                            | Colour code                    | Art. No.   |
|----------------------------------------------------------------------------------------------------------------------------------------|--------------------------------|------------|
|  <p>RESECTOSCOPY SHEATH; 19 Fr.<br/>1 stopcock</p> | <input type="checkbox"/> white | 630-300-19 |

## OBTURATORS 19/22 Fr.

| Size                                                                                                          | Colour code                    | Art. No.   | Information                                                                                                |
|---------------------------------------------------------------------------------------------------------------|--------------------------------|------------|------------------------------------------------------------------------------------------------------------|
|  <p>STANDARD OBTURATOR</p> | <input type="checkbox"/> white | 630-315-19 |                                                                                                            |
|  <p>VISUAL OBTURATOR</p>   | <input type="checkbox"/> white | 630-325-19 |  <p>601-103-30HD2</p> |

## RESECTOSCOPY SYSTEM FOR Ø 2.9 mm TELESCOPES



- ▶ Reusable electrodes for use with **bipolar** current and conductive solution (NaCl 0.9%)
- ▶ SALINÆ disposable electrodes for use with **bipolar** current and conductive solution (NaCl 0.9%)
- ▶ Reusable electrodes for use with **monopolar** current and non-conductive solution (Sorbitol, Mannitol, Glycine)

19/22 Fr.

### MONOPOLAR ELECTRODES; reusable BIPOLAR ELECTRODES; reusable & single use

19/22 Fr.

| Description                         | Monopolar                      | Bipolar                             | SALINÆ Single use electrodes*       |  |
|-------------------------------------|--------------------------------|-------------------------------------|-------------------------------------|--|
|                                     | <input type="checkbox"/> white | <input type="checkbox"/> white/blue | <input type="checkbox"/> white/blue |  |
| LOOP ELECTRODE;<br>angled; 12°      | 630-340-00                     | 630-340-00B                         | 630-340-00B-S                       |  |
| LOOP ELECTRODE;<br>straight; 0°/12° | 630-340-05                     | 630-340-05B                         | 630-340-05B-S                       |  |
| BALL ELECTRODE;<br>Ø 3 mm           | 630-340-10                     | 630-340-10B                         | 630-340-10B-S                       |  |
| KNIFE ELECTRODE;<br>angled          | 630-340-15                     | 630-340-15B                         | 630-340-15B-S                       |  |
| ROLLER ELECTRODE;<br>Ø 3 mm         | 630-340-20                     | -                                   | -                                   |  |

\*Sterile, single packaged; 5 pcs./box  
For cable connection see cable overview in „Accessories“

**Example:**



630-340-05B or 630-340-05B-S

Reusable and SALINÆ single use electrodes for **bipolar** applications come with white/blue insulation.

### HF CONNECTION CABLES; **MONOPOLAR** for working elements and flexible electrodes

|                                                                                                                                                                  |                                                        |  |                                                                                       |
|------------------------------------------------------------------------------------------------------------------------------------------------------------------|--------------------------------------------------------|--|---------------------------------------------------------------------------------------|
| <b>Available for following units:</b><br>Erbe/Storz; Ø 5.0 mm<br>Valleylab; Conmed; Bowa; Ø 8.0 mm<br>TONTARRA mod. PWT-400; Equipment with banana plug Ø 4.0 mm | <b>3.0 m</b><br>582-531-02<br>582-532-03<br>582-533-04 |  | For further information and pictures see overview of cables in chapter „Accessories“. |
|------------------------------------------------------------------------------------------------------------------------------------------------------------------|--------------------------------------------------------|--|---------------------------------------------------------------------------------------|

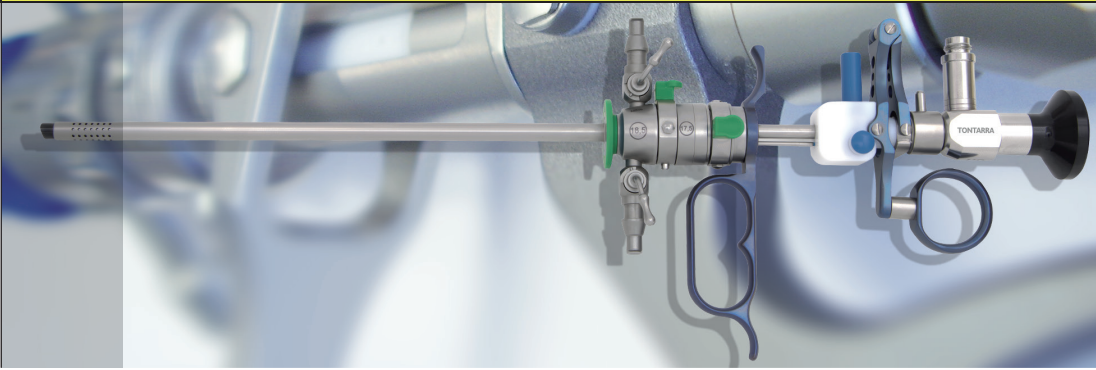

## MINI- CYSTO-RESECTOSCOPY

Ø 2.9 mm

◀ 17.5/18.5 Fr.

◀ 17 Fr.



## MINI-CYSTO-RESECTOSCOPY SYSTEM FOR Ø 2.9 mm TELESCOPES



- ▶ Resectoscope plus additional working sheath with instrument channel 5 Fr.
- ▶ For biopsy and treatments inside the bladder

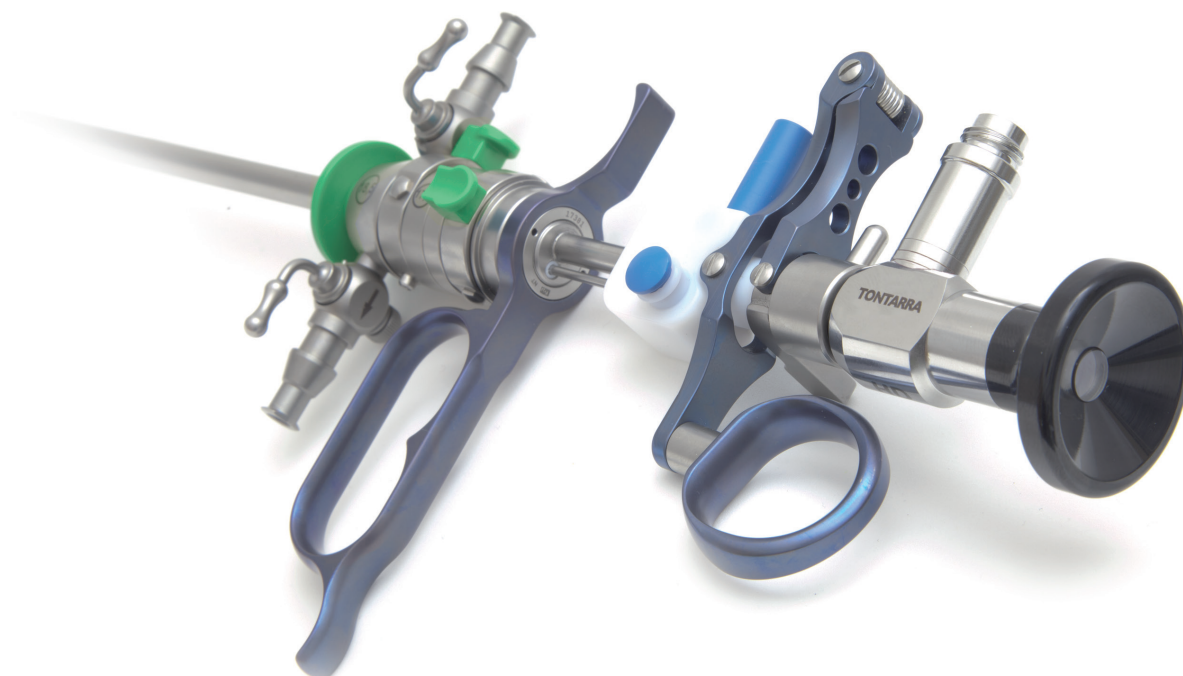

TONTARRA's Mini-Cysto-Resectoscope can be used for treatment, especially inside the bladder. The small size of the instrument – the diameter of the round outer sheath only measures 18.5 Fr. - allows a less traumatic introduction through the urethra, and features an excellent maneuverability within the sensible structures of the lower urinary tract. Its handiness plus the functional shapes of the resectoscopic electrodes allow a perfectly controllable tissue ablation.

For cystoscopy, flexible instruments (FL 400 mm) and flexible monopolar and semi-flexible bipolar HF electrodes are introduced through the 5 Fr. instrument channel of the working sheath.

Resectoscopic treatments with HF electrodes are performed with bipolar current and conductive solution (saline solution NaCl 0.9 %).

The Quick Lock connecting system between inner, outer and working sheath provides a smooth sheath exchange.

An optimized continuous flow rate assures a clear endoscopic view.

**MINI-CYSTO-RESECTOSCOPY SYSTEM FOR Ø 2.9 mm TELESCOPES**









▶ Continuous flow resectoscopy- & working sheaths with 5 Fr. instrument channel

■ 17.5/18.5 Fr.

**CONTINUOUS FLOW SHEATHS; WORKING SHEATHS ▶ rotatable or non-rotatable**



| Description                                                                                                                                                           | Colour code                          | Art. No.   |
|-----------------------------------------------------------------------------------------------------------------------------------------------------------------------|--------------------------------------|------------|
| <b>rotatable</b>                                                                                                                                                      |                                      |            |
| OUTER SHEATH<br>18.5 Fr.                                                            | ■ green                              | 582-180-24 |
| INNER SHEATH<br>17.5 Fr.                                                           | ■ green                              | 582-180-26 |
| WORKING SHEATH with instrument channel 5 Fr.<br>for use with Art. No. 582-180-24  | ■ green                              | 582-180-39 |
| <b>non-rotatable</b>                                                                                                                                                  |                                      |            |
| OUTER SHEATH<br>18.5 Fr.                                                          | ■ green/blue                         | 582-180-22 |
| INNER SHEATH<br>17.5 Fr.                                                          | ■ green                              | 582-180-21 |
| WORKING SHEATH with instrument channel 5 Fr.<br>for use with Art. No. 582-180-22  | ■ green/blue                         | 582-180-38 |
| Sheaths with allround perforation                                                | Recommended telescope: 601-103-30HD2 |            |

Inner and outer sheaths are compatible to Laser working elements and accessories: see chapter „Laser instruments“

MINI-CYSTO-RESECTOSCOPY SYSTEM FOR Ø 2.9 MM TELESCOPES



■ 17.5 Fr.

- ▶ Single flow sheath; obturator

SINGLE FLOW SHEATH; OBTURATOR



| Description                                           | Colour code | Art. No.   |
|-------------------------------------------------------|-------------|------------|
| <b>Standard</b>                                       |             |            |
| SINGLE FLOW SHEATH; turnable with stopcock;<br>17 Fr. | ■ green     | 582-180-15 |
| OBTURATOR for single flow and continuous flow sheaths | ■ green     | 582-180-23 |

MICRO TOOLS COMPATIBLE TO THE MINI-CYSTO-RESECTOSCOPE

Through the outer sheath in combination with the working sheath, tools for cystoscopy can be applied:

- ▶ 400 mm flexible instruments (5 Fr. working channels)

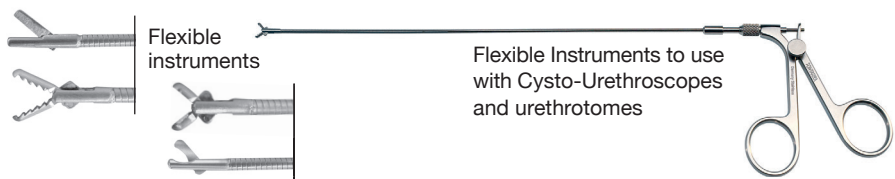

- ▶ Flexible **monopolar** and semi-flexible **bipolar** HF electrodes, 5 Fr.

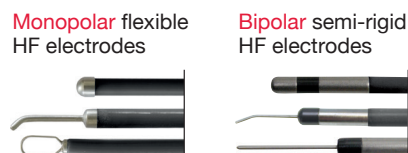

See chapter "Cystoscopy" for more details on the micro tools, as well as for cables used with HF electrodes used in cystoscopy.

## MINI-CYSTO-RESECTOSCOPY SYSTEM FOR Ø 2.9 mm TELESCOPES





- ▶ **Bipolar** working elements
- ▶ Reusable electrodes for use with **bipolar** current and conductive solution (NaCl 0.9%)
- ▶ SALINÆ disposable electrodes for use with **bipolar** current and conductive solution (NaCl 0.9%)

■ 17.5/18.5 Fr.



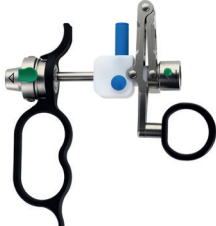

### BIPOLAR WORKING ELEMENTS; CLOSED HANDLE

- ▶ For use with electrodes in **bipolar** current mode and conductive solution (physiologic saline solution, NaCl 0.9 %)



| Description                                                                                                   |                                                                                      | Art. No.      |
|---------------------------------------------------------------------------------------------------------------|--------------------------------------------------------------------------------------|---------------|
| WORKING ELEMENT;<br>active                                                                                    |    | 582-180-01B   |
| WORKING ELEMENT;<br>passive                                                                                   |   | 582-180-00B   |
| SAFETY DISTANCE HOLDER<br>for bipolar working element 582-180-01B; 582-180-00B (2.0 mm width);<br>10 pc./unit |  | 582-150-02GUB |

### BIPOLAR HF RESECTOSCOPY ELECTRODES

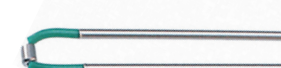
| Description                     | Colour code | Reusable    | SALINÆ Single use electrodes* |                                                                                       |
|---------------------------------|-------------|-------------|-------------------------------|---------------------------------------------------------------------------------------|
| HF LOOP ELECTRODE<br>angled 30° | ■ green     | 582-180-40B | 582-180-40B-S                 |  |
| HF LOOP ELECTRODE<br>straight   | ■ green     | 582-180-41B | 582-180-41B-S                 |  |
| HF KNIFE ELECTRODE              | ■ green     | 582-180-42B | 582-180-42B-S                 |  |
| HF BALL ELECTRODE<br>Ø 2 mm     | ■ green     | 582-180-43B | 582-180-43B-S                 |  |
| HF ROLLER ELECTRODE<br>Ø 2 mm   | ■ green     | 582-180-44B | -                             |  |

\* sterile, single packaged; 5 pcs./box





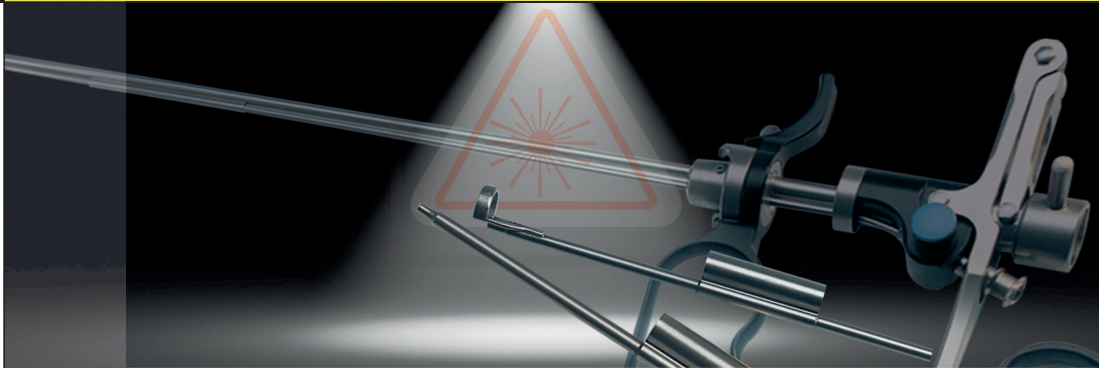

# INSTRUMENTS FOR LASER THERAPY

Laser-Cystoscopy

◀ 23 Fr.

Laser-Resectoscopy

◀ 24/26 Fr.

◀ 27/28.5 Fr.

◀ 19/22 Fr.

◀ 17.5/18.5 Fr.













**LASER-CYSTOSCOPY**

▶ System for Ø 4.0 mm telescopes



■ 23.5 Fr.

**LASER-CYSTOSCOPY ▶ 23 Fr.**

| Description                                                                                                                                                                                                                     | Art. No.   | Information                                                                                                                                                                                                                                                       |
|---------------------------------------------------------------------------------------------------------------------------------------------------------------------------------------------------------------------------------|------------|-------------------------------------------------------------------------------------------------------------------------------------------------------------------------------------------------------------------------------------------------------------------|
| LASER-CYSTOSCOPY sheath; 2 stopcocks<br>                                                                                                      | 630-045-23 | <br><br> |
| STANDARD OBTURATOR  23 Fr.<br>                               | 630-045-30 |                                                                                                                                                                                |
| VISUAL OBTURATOR  23 Fr.<br>                              | 630-045-35 | <br>601-104-30HD<br>601-104-30HD2<br>(601-104-12HD)<br>(601-104-12HD2)                                                                                                        |
| TELESCOPE BRIDGE; 1 instrument channel 8 Fr.  23 Fr.<br> | 630-045-40 |                                                                                                                                                                              |

# LASER-RESECTOSCOPY

► System for Ø 4.0 mm telescopes / for exchangeable laser guide tubes



■ 24/26 Fr.  
■ 27/28.5 Fr.

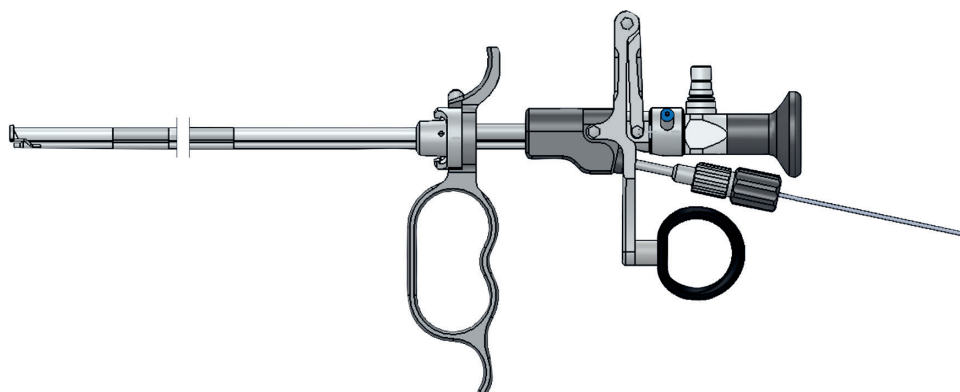

## LASER-WORKING ELEMENT ► for exchangeable laser guide tubes

| Description                      | Art. No.   | Information                                             |
|----------------------------------|------------|---------------------------------------------------------|
| LASER-WORKING ELEMENT<br>passive | 630-048-00 | recommended telescope:<br>601-104-30HD<br>601-104-30HD2 |



► to adapt with resectoscopy continuous flow sheaths



## EXCHANGEABLE LASER GUIDE TUBES

| Diameter | Art. No.   | Art. No.                  |
|----------|------------|---------------------------|
|          | GUIDE TUBE | GUIDE TUBE with retractor |
| Ø 0.8 mm | 630-048-08 | 630-048-58                |
| Ø 1.0 mm | 630-048-10 | 630-048-60                |
| Ø 1.2 mm | 630-048-12 | 630-048-62                |
| Ø 1.4 mm | 630-048-14 | 630-048-64                |

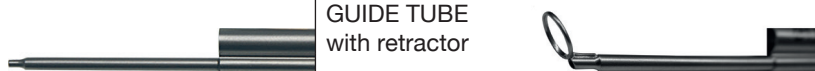

## LASER-RESECTOSCOPY

- ▶ Working elements for fixed laser guide tubes for Ø 4.0 & Ø 2.9 mm telescopes
- ▶ Accessories for laser systems



Mini-Resectoscopy

- 24/26 Fr.
- 27/28.5 Fr.
- 19/22 Fr.





Laser-working elements; passive; for fixed laser guide tubes

### LASER-WORKING ELEMENTS **PASSIVE** ▶ fibers Ø 0.8 mm & Ø 1.2 mm LL

| Description                                                                                                          | Compatibility         |                     | Art. No.            |  |
|----------------------------------------------------------------------------------------------------------------------|-----------------------|---------------------|---------------------|--|
|                                                                                                                      | Telescopes Size       | for fibres Ø 1.2 mm | for fibres Ø 0.8 mm |  |
| LASER-WORKING ELEMENT passive<br>▶ with LuerLock connectors<br>▶ compatible to Tuohy Borst adapter and Fiber intakes | Ø 4.0 mm telescopes*  | 630-047-12          | 630-047-08          |  |
|                                                                                                                      | Ø 2.9 mm telescopes** | 630-046-12          | 630-046-08          |  |

\* To use with continuous flow sheaths 24/26 Fr. and 27/28.5 Fr. and urethrotome sheath 21 Fr. (Art. No. 630-400-21)  
 \*\* To use with continuous flow sheaths 19/22 Fr.

### ACCESSORIES FOR LASER-WORKING ELEMENTS

|                                                                                                                              |                                                                                      |                                                                                                                                                 |
|------------------------------------------------------------------------------------------------------------------------------|--------------------------------------------------------------------------------------|-------------------------------------------------------------------------------------------------------------------------------------------------|
|                                           |  |                                                            |
| FIBER INTAKE (short version)<br>▶ Adapter for laser probes                                                                   | FIBER INTAKE (long version)<br>▶ Adapter for laser probes                            | TUOHY BORST ADAPTER<br>▶ with LuerLock connection (stainless steel) and silicone seal<br>▶ effectively helps to eliminate the backflow of fluid |
| 630-047-25                                                                                                                   | 630-047-26                                                                           | 630-047-30                                                                                                                                      |
| Compatible to Laser working elements for fixed laser guide tubes (above) and exchangeable laser guided tubes (previous page) |                                                                                      | Compatible to: 630-046-08, 630-046-12, 630-047-08, 630-047-12                                                                                   |

## MINI LASER-RESECTOSCOPY

- ▶ The TONTARRA 18.5 Fr. Mini-Laser Resectoscope opens a new era for the surgeon in the field of BPH treatment.



Mini-Resectoscopy

■ 17.5/18.5 Fr.



### HOLMIUM:YAG Laser

- ▶ Wavelength 2.100  $\mu$
- ▶ HoLEP (Holmium Laser Enucleation of the Prostate)
- ▶ Urethral Strictures
- ▶ Bladder and Urethral Tumors

### KTP – Potassium Tytanil Phosphate Laser (Green Laser)

- ▶ Wavelength 532  $\mu$
- ▶ PVP (Selective Photo-Evaporation of the Prostate)
- ▶ BPH (Benign Prostatic Hyperplasia)

### TULIUM Tm:YAG Laser

- ▶ Wavelength 2.100  $\mu$
- ▶ BPH (Benign Prostatic Hyperplasia)
- ▶ Urethral Strictures
- ▶ Bladder and Urethral Tumors

### Technical and application advantages:

- ▶ **HOLMIUM:YAG Laser**
  - Enucleation and removal of the prostate lobes through the use of Morcellator
  - No bleeding and short catheterization
- ▶ **KTP – Potassium Tytanil Phosphate Laser (Green Laser)**
  - Reduced bleeding
  - Catheterization less than 30 hours
  - Resumption of working activity within 7-10 days
- ▶ **TULIUM Tm:YAG Laser**
  - Enucleation, Vaporization and Vaporesection Techniques
  - Minimal production of air bubbles – good vision
  - Bloodless endoscopic field

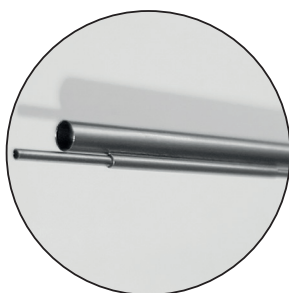

The 18.5 Fr. Mini-Laser Resectoscope allows use of laser fibers up to 0.8 mm. A fixed special guiding tube enables the surgeon to perfectly control the laser fiber movements.

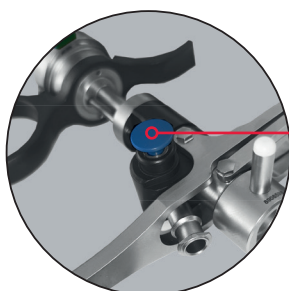

**Push Button** for better control and adjustment of the laser fiber

### 18.5 Fr. Mini-Laser Resectoscope is part of the TONTARRA “Laser-Line”:

- ▶ Superior quality vision thanks to Ø2.9 mm 2nd generation HD+2 Telescopes
- ▶ Thin diameter and rotatable sheaths
- ▶ Continuous flow
- ▶ Quick-Lock connection system
- ▶ High level performance

## MINI LASER-RESECTOSCOPY

- ▶ The TONTARRA 18.5 Fr. Mini-Laser Resectoscope opens a new era for the surgeon in the field of BPH treatment.



Mini-Resectoscopy  
17.5/18.5 Fr.

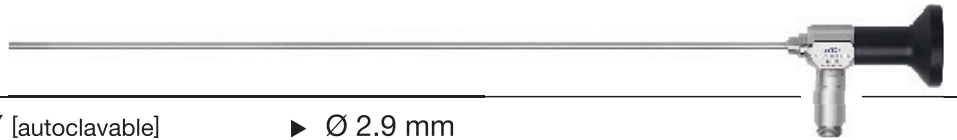

### TELESCOPES FOR UROLOGY [autoclavable] ▶ Ø 2.9 mm

| Description     |                 |           | Art. No.      | · <b>Field of view: 80°</b><br>· Compatible with most instrument- and camera systems |
|-----------------|-----------------|-----------|---------------|--------------------------------------------------------------------------------------|
| Telescopes HD+2 | ▶ Ø 2.9 mm; 0°  | FL 300 mm | 601-103-00HD2 |                                                                                      |
| Telescopes HD+2 | ▶ Ø 2.9 mm; 12° | FL 300 mm | 601-103-12HD2 |                                                                                      |
| Telescopes HD+2 | ▶ Ø 2.9 mm; 30° | FL 300 mm | 601-103-30HD2 |                                                                                      |

### MINI-LASER WORKING ELEMENT; closed handle; passive

- ▶ For 2.9 mm telescopes (30° scope is recommended)
- ▶ For laser probes of up to 0.8 mm

| Description                                                                                                                                                | Art. No.   |  |
|------------------------------------------------------------------------------------------------------------------------------------------------------------|------------|--|
| <b>MINI-LASER WORKING ELEMENT; passive</b><br>- 17.5 Fr.<br>- QuickLock connection<br>- with push button<br>- with fixed guide tube<br>- Color code: white | 630-049-00 |  |

### ACCESSORIES FOR LASER-WORKING ELEMENTS

|                                                                   |                                                                  |                                                                                                                                                        |
|-------------------------------------------------------------------|------------------------------------------------------------------|--------------------------------------------------------------------------------------------------------------------------------------------------------|
|                                                                   |                                                                  |                                                                                                                                                        |
| <b>FIBER INTAKE (short version)</b><br>▶ Adapter for laser probes | <b>FIBER INTAKE (long version)</b><br>▶ Adapter for laser probes | <b>TUOHY BORST ADAPTER</b><br>▶ with LuerLock connection (stainless steel) and silicone seal<br>▶ effectively helps to eliminate the backflow of fluid |
| 630-047-25                                                        | 630-047-26                                                       | 630-047-30                                                                                                                                             |

## MINI LASER-RESECTOSCOPY



- ▶ The TONTARRA 18.5 Fr. Mini-Laser Resectoscope opens a new era for the surgeon in the field of BPH treatment.



Mini-Resectoscopy  
17.5/18.5 Fr.

### CONTINUOUS FLOW SHEATHS; WORKING SHEATHS ▶ rotatable



| Rotatable                             |                                                                                     | Color code | Art. No.   |
|---------------------------------------|-------------------------------------------------------------------------------------|------------|------------|
| OUTER SHEATH<br>▶ 18.5 Fr.            |    | ■ green    | 582-180-24 |
| INNER SHEATH<br>▶ 17.5 Fr.            |   | ■ green    | 582-180-26 |
| OBTURATOR for continuous flow sheaths |  | ■ green    | 582-180-23 |







## URETHROTOMY

◀ 21 Fr.

◀ 15.5 Fr.



# URETHROTOMY

► Schematic overview

URETHROTOMY

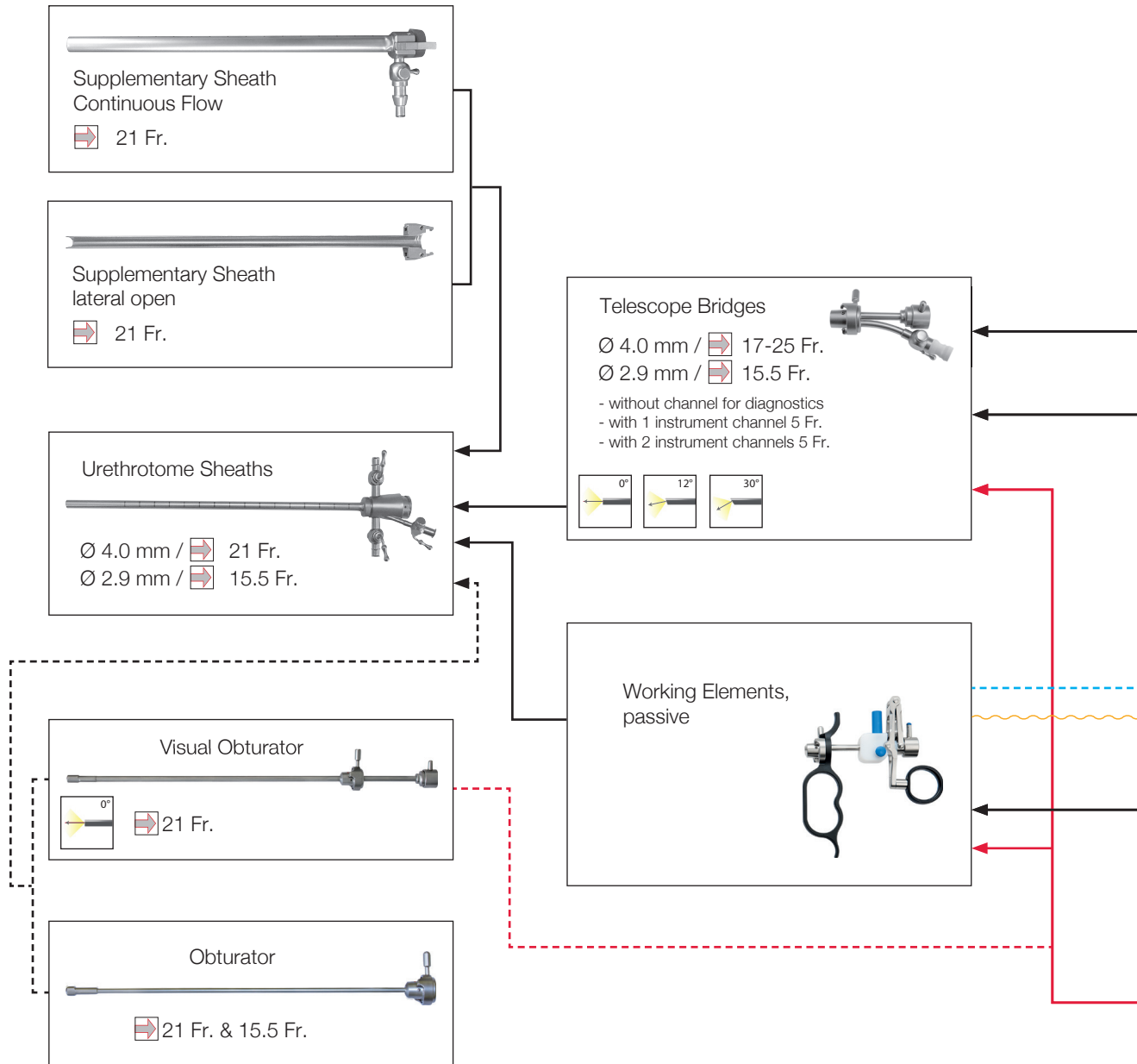



Systems and components for Ø 4.0 mm telescopes  
 Systems and components for Ø 2.9 mm telescopes

21 Fr.  
 15.5 Fr.

Flexible Instruments;  
 6 different inserts  
**FL** 400 mm  
 (Also for use in Cysto-Urethroscopy)

HF Flexible Electrodes  
**monopolar**  
 Sizes 3-7 Fr.

HF Semi-Flexible Electrodes **bipolar**  
 Sizes 3-7 Fr.

HF Generator

Stricture Knives

Telescopes Ø 4.0 mm & Ø 2.9 mm; 0°

HF Connection cables (3 types):

**monopolar**  
 - - - - - to connect HF generator:  
 · to working element  
 · to flexible **monopolar** HF electrodes for cystoscopy

**bipolar**  
 ~ ~ ~ ~ ~ to connect working element to HF generator

~ ~ ~ ~ ~ to connect semi-flexible **bipolar** HF electrodes for cystoscopy to HF generator

# URETHROTOME SYSTEM

► Visual Urethrotome system for Ø 4.0 mm telescopes



21 Fr.

## VISUAL URETHROTOME SYSTEM ► 21 Fr. for Ø 4.0 mm telescopes

| Description                                                                                                                                                                | Art. No.                                                                                   | Information                                                                                                         |
|----------------------------------------------------------------------------------------------------------------------------------------------------------------------------|--------------------------------------------------------------------------------------------|---------------------------------------------------------------------------------------------------------------------|
| <p>URETHROTOME SHEATH 21 Fr.<br/>2 stopcocks; graduated; 1 instrument channel 5 Fr.</p>  | 630-400-21                                                                                 |                                  |
| <p>SUPPLEMENTARY SHEATH lateral open</p>                                                  |  21 Fr.   | 630-400-30                                                                                                          |
| <p>SUPPLEMENTARY SHEATH for continuous flow</p>                                         |  21 Fr.  |                                 |
| <p>STANDARD OBTURATOR</p>                                                               |  21 Fr. | 630-400-50                                                                                                          |
| <p>OBTURATOR with 1 instrument channel 5 Fr.</p>                                        |  21 Fr. | 630-400-60                                                                                                          |
| <p>VISUAL OBTURATOR</p>                                                                |  21 Fr. |  601-104-00HD<br>601-104-00HD2 |
| <p>TELESCOPE BRIDGE 1 instrument channel 5 Fr.</p>                                     |                                                                                            | 630-400-70                                                                                                          |

**WORKING ELEMENTS** passive for Ø 4 mm telescopes, bipolar and monopolar: see chapter resectoscopy.







## URETHROTOME SYSTEM

- ▶ Visual Urethrotome system 15.5 Fr. for Ø 2.9 mm telescopes
- ▶ Stricture Knives for 21 Fr. and 15.5 Fr. Systems

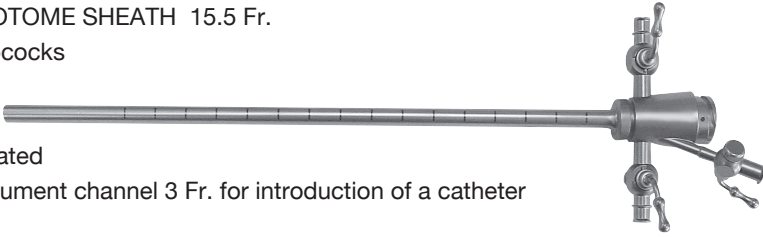







15.5 Fr.  
21 Fr.

### VISUAL URETHROTOME SYSTEM ▶ 15.5 Fr. for Ø 2.9 mm telescopes

| Description                                                                                                                                                                                                                                                                                                                                    | Art. No.     | Information                                                                                                       |
|------------------------------------------------------------------------------------------------------------------------------------------------------------------------------------------------------------------------------------------------------------------------------------------------------------------------------------------------|--------------|-------------------------------------------------------------------------------------------------------------------|
| <b>URETHROTOME SHEATH 15.5 Fr.</b> <ul style="list-style-type: none"> <li>▶ 2 stopcocks</li> <li>▶ graduated</li> <li>▶ 1 instrument channel 3 Fr. for introduction of a catheter</li> </ul>                                                                 | 630-401-15   |                                |
| <b>STANDARD OBTURATOR</b>  15.5 Fr.                                                                                                                                         | 630-401-26   |                                                                                                                   |
| <b>TELESCOPE BRIDGE 1 instrument channel 5 Fr.</b>                                                                                                                                                                                                           | 630-401-30   |  601-103-00HD<br>601-103-00HD2 |
| <b>URETHROTOME WORKING ELEMENT for 2.9 mm telescopes</b> <ul style="list-style-type: none"> <li>▶ passive</li> <li>▶ Working element can only be used with 15.5 Fr. Urethrotome</li> <li>▶ only for mechanical use and not with HF application</li> </ul>  | 630-405-60BU |                                                                                                                   |

### STRICTURE KNIVES ▶ 21 Fr. and 15.5 Fr.

| Description                   |  21 Fr. |  15.5 Fr. | Non-HF electrodes                                                                     |
|-------------------------------|--------------------------------------------------------------------------------------------|----------------------------------------------------------------------------------------------|---------------------------------------------------------------------------------------|
| STRICTURE KNIFE straight      | 630-405-05                                                                                 | 630-406-01                                                                                   |  |
| STRICTURE KNIFE wave shaped   | 630-405-10                                                                                 | 630-406-06                                                                                   |  |
| STRICTURE KNIFE round shaped  | 630-405-15                                                                                 | —                                                                                            |  |
| STRICTURE KNIFE sickle shaped | 630-405-20                                                                                 | 630-406-16                                                                                   |  |

# URETHROTOME OTIS

► Urethrotome for adults

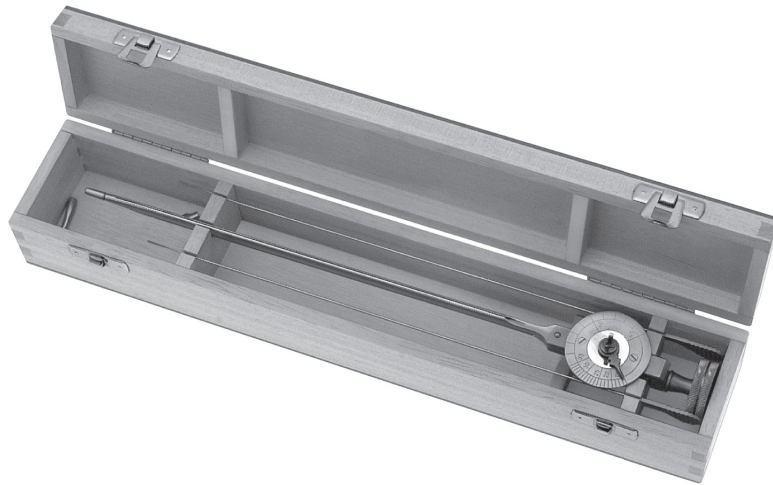

## OTIS URETHROTOME for adults

| Description                                                                                                                                                                      | Art. No.                                                                                                                                                                         | Information                                                                                                                                                                         |
|----------------------------------------------------------------------------------------------------------------------------------------------------------------------------------|----------------------------------------------------------------------------------------------------------------------------------------------------------------------------------|-------------------------------------------------------------------------------------------------------------------------------------------------------------------------------------|
| <b>SET includes:</b> <ul style="list-style-type: none"> <li>► OTIS dilatator (see picture right)</li> <li>► 3 x tips (ball, flat, conical)</li> <li>► 2 x knives</li> </ul>      | 582-720-00                                                                                                                                                                       |                                                                                                                                                                                     |
| Knife                                                                                                                                                                            | 582-720-05                                                                                                                                                                       |                                                                                                                                                                                     |
| <div style="display: flex; align-items: center; justify-content: center;"> <div style="text-align: center; margin-right: 10px;"> <p>Tip ball</p> <p>582-720-01</p> </div> </div> | <div style="display: flex; align-items: center; justify-content: center;"> <div style="text-align: center; margin-right: 10px;"> <p>Tip flat</p> <p>582-720-02</p> </div> </div> | <div style="display: flex; align-items: center; justify-content: center;"> <div style="text-align: center; margin-right: 10px;"> <p>Tip conical</p> <p>582-720-03</p> </div> </div> |

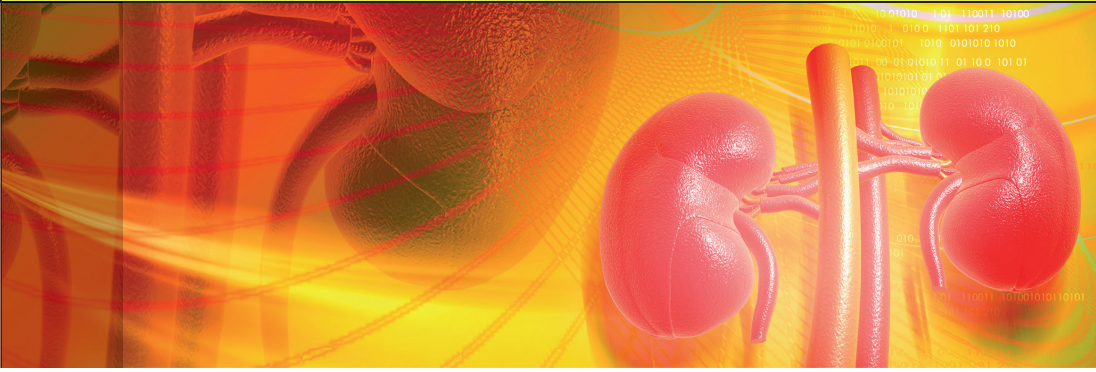

# URETERO-RENOSCOPY

## URETERO-RENSCOPY



- ▶ Uretero-Renoscopes; 30.000 pixel; 2 working channels (1x 4 Fr. and 1x 5 Fr.)
- ▶ Flexible stone baskets





### URETERO-RENSCOPIES [autoclavable]

| Description      |                                                                       | Art. No.                                           |
|------------------|-----------------------------------------------------------------------|----------------------------------------------------|
| URETERO-RENSCOPE | [1 working channel 5 Fr.]<br>▶ 8.0/9.8 Fr.; 12°<br>▶ 8.0/9.8 Fr.; 12° | FL 315 mm<br>601-110-05<br>FL 430 mm<br>601-110-10 |
|                  | [1 working channel 4 Fr.]<br>▶ 6.0/7.5 Fr.; 12°<br>▶ 6.0/7.5 Fr.; 12° | FL 315 mm<br>601-110-15<br>FL 430 mm<br>601-110-20 |



### FLEXIBLE STONE BASKETS ▶ **FL** 900 mm ⇄ 3 Fr. & 5 Fr.

| Description                                                                           | Art. No.   | Information                                                                           |
|---------------------------------------------------------------------------------------|------------|---------------------------------------------------------------------------------------|
| HANDLE<br>▶ for 3 Fr. and 5 Fr. stone catcher;<br>▶ colour code: blue                 | 582-610-02 |   |
| STONE CATCHER; <b>3 Fr.</b><br>▶ with 4 strings;<br>▶ with tubus;<br>▶ without handle | 582-610-03 |  |
| STONE CATCHER; <b>5 Fr.</b><br>▶ with 4 strings;<br>▶ with tubus;<br>▶ without handle | 582-610-05 |  |







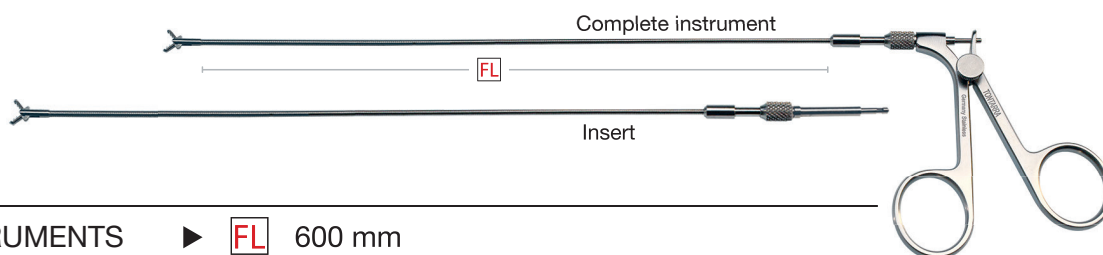

# URETERO-RENOSCOPY

► Flexible Instruments; FL 600 mm

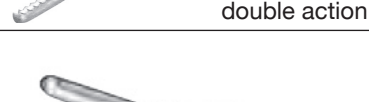
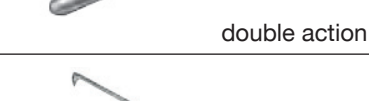

**FLEXIBLE INSTRUMENTS** ► **FL** 600 mm

| Description                                  | 5 Fr.       | 4 Fr.       | 3 Fr.                                                         | Information                                                                                            |
|----------------------------------------------|-------------|-------------|---------------------------------------------------------------|--------------------------------------------------------------------------------------------------------|
| BIOPSY FORCEPS<br>► flexible; oval; complete | 583-310-16  | -           | 583-310-10                                                    | <br>double action   |
| INSERT only                                  | 583-310-16A | -           | 583-310-10A                                                   |                                                                                                        |
| SCISSORS<br>► flexible; complete             | 583-320-16  | -           | -                                                             | <br>single action   |
| INSERT only                                  | 583-320-16A | -           | -                                                             |                                                                                                        |
| BIOPSY FORCEPS<br>flexible; oval; serrated   | 583-350-16  | -           | -                                                             | <br>double action  |
| INSERT only                                  | 583-350-16A | -           | -                                                             |                                                                                                        |
| GRASPING FORCEPS<br>► flexible               | 583-360-16  | -           | -                                                             | <br>double action |
| INSERT only                                  | 583-360-16A | -           | -                                                             |                                                                                                        |
| GRASPING FORCEPS<br>► Alligator jaw          | 583-380-16  | -           | 583-360-10                                                    | <br>double action |
| INSERT only                                  | 583-380-16A | -           | 583-360-10A                                                   |                                                                                                        |
| GRASPING FORCEPS<br>► flexible; serrated     | 583-370-16  | 583-370-12  | -                                                             | <br>double action |
| INSERT only                                  | 583-370-16A | 583-370-12A | -                                                             |                                                                                                        |
| GRASPING FORCEPS<br>► for stone fragments    | -           | 583-473-12  | -                                                             | <br>double action |
| INSERT only                                  | -           | 583-473-12A | -                                                             |                                                                                                        |
| TENACULUM FORCEPS<br>► for large fragments   | -           | 583-380-12  | -                                                             | <br>double action |
| INSERT only                                  | -           | 583-380-12A | -                                                             |                                                                                                        |
| HANDLE only (spare part)                     | 583-305-00  |             | for all urologic micro instruments with Art. No's. 583-XXX-XX |                                                                                                        |

# URETERO-RENSCOPY

► Semi-rigid Instruments; FL 600 mm

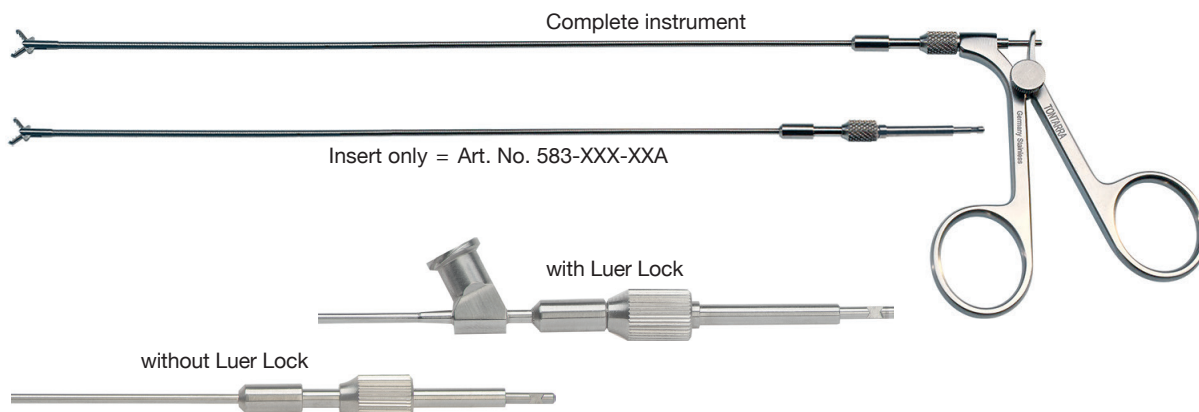

## SEMI-RIGID INSTRUMENTS

► 600 mm 4 Fr. & 5 Fr.

| Description                                                                        | Ø 5 Fr.       |             | Ø 4 Fr.                                                                    |              | Information                                                 |
|------------------------------------------------------------------------------------|---------------|-------------|----------------------------------------------------------------------------|--------------|-------------------------------------------------------------|
|                                                                                    | with LuerLock | Standard    | with LuerLock                                                              | Standard     |                                                             |
| BIOPSY FORCEPS;<br>oval                                                            | 583-410-16LL  | 583-410-16  | 583-410-12LL                                                               | 583-410-12   | <br>double action                                           |
| INSERT only                                                                        | 583-410-16LLA | 583-410-16A | 583-410-12LLA                                                              | 583-410-12A  |                                                             |
| ALLIGATOR FORCEPS                                                                  | 583-460-16LL  | 583-460-16  | 583-460-12LL                                                               | 583-460-12   | <br>double action                                           |
| INSERT only                                                                        | 583-460-16LLA | 583-460-16A | 583-460-12LLA                                                              | 583-460-12A  |                                                             |
| FOREIGN BODY<br>FORCEPS; long jaw<br>part Ø 1.7 mm; spoon<br>serrated              | 583-472-16LL  | 583-472-16  | 583-472-12LL                                                               | 583-472-12   | <br>double action                                           |
| INSERT only                                                                        | 583-472-16LLA | 583-472-16A | 583-472-12LLA                                                              | 583-472-12A  |                                                             |
| MOUSE TEETH<br>GRASPING FORCEPS;<br>for grasping of larger<br>stones and fragments | 583-480-16LL  | 583-480-16  | *583-480-12LL                                                              | *583-480-12  | <br>4 Fr.: opening to<br>both sides<br>5 Fr.: double action |
| INSERT only                                                                        | 583-480-16LLA | 583-480-16A | *583-480-12LLA                                                             | *583-480-12A |                                                             |
| MICRO SCISSORS/<br>URETER SLITTING<br>SHEAR<br>Ø 1.7 mm; upwards<br>cutting        | 583-490-16LL  | 583-490-16  | -                                                                          | -            | <br>single action                                           |
| INSERT only                                                                        | 583-490-16LLA | 583-490-16A | -                                                                          | -            |                                                             |
| HANDLE only<br>(spare part)                                                        | 583-305-00    |             | for all urologic micro instruments 5/7/9 Fr.<br>with Art. No's. 583-XXX-XX |              |                                                             |

\* Rigid; the miniaturization of this particular forceps needs the use of a very thin rigid tube, which has a certain flexibility, but cannot be bended to the same degree as semi-rigid forceps.



# NEPHROSCOPY

# NEPHROSCOPY

► Schematic overview



Ø 2.8 mm nephroscopes for 24 Fr. or 26 Fr. nephroscopy sheaths  
(FL 200 mm or 250 mm; working channel Ø 5.0 mm)

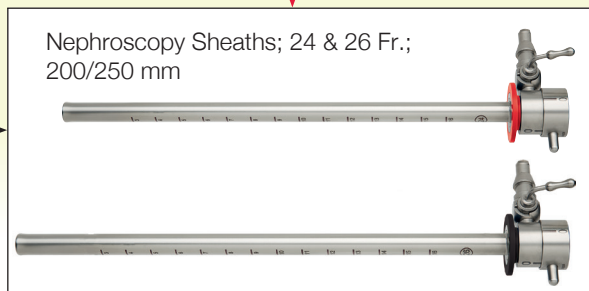
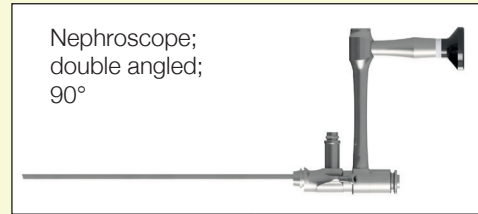

Ø 1.8 mm compact nephroscopes for 23 Fr. nephroscopy sheath  
(FL 220 mm; working channel Ø 4.3 mm)

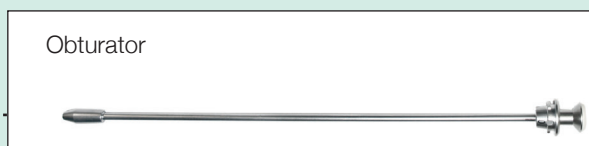
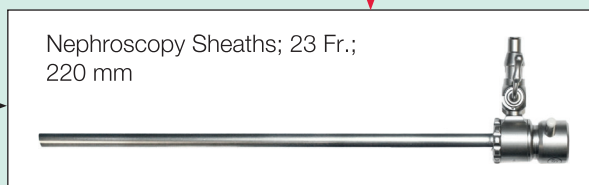
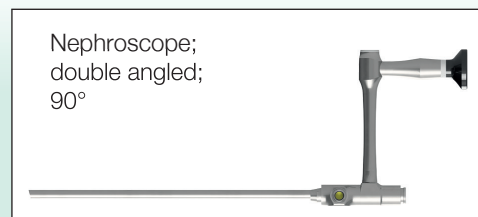
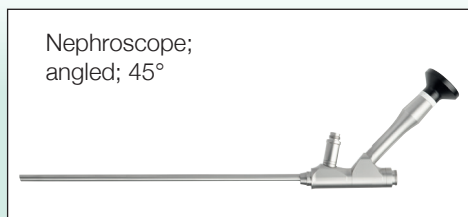

NEPHROSCOPY



Systems and components for Ø 2.8 mm telescopes 24 & 26 Fr.  
 Systems and components for Ø 1.8 mm telescopes 23 Fr.  
 Mini-Compact nephroscope system 18/19.5/24 Fr.

Mini-Compact nephroscope for 18 Fr./19.5 Fr./24 Fr. nephroscopy sheaths  
 (FL 220 mm; working channel Ø 2.2 mm)

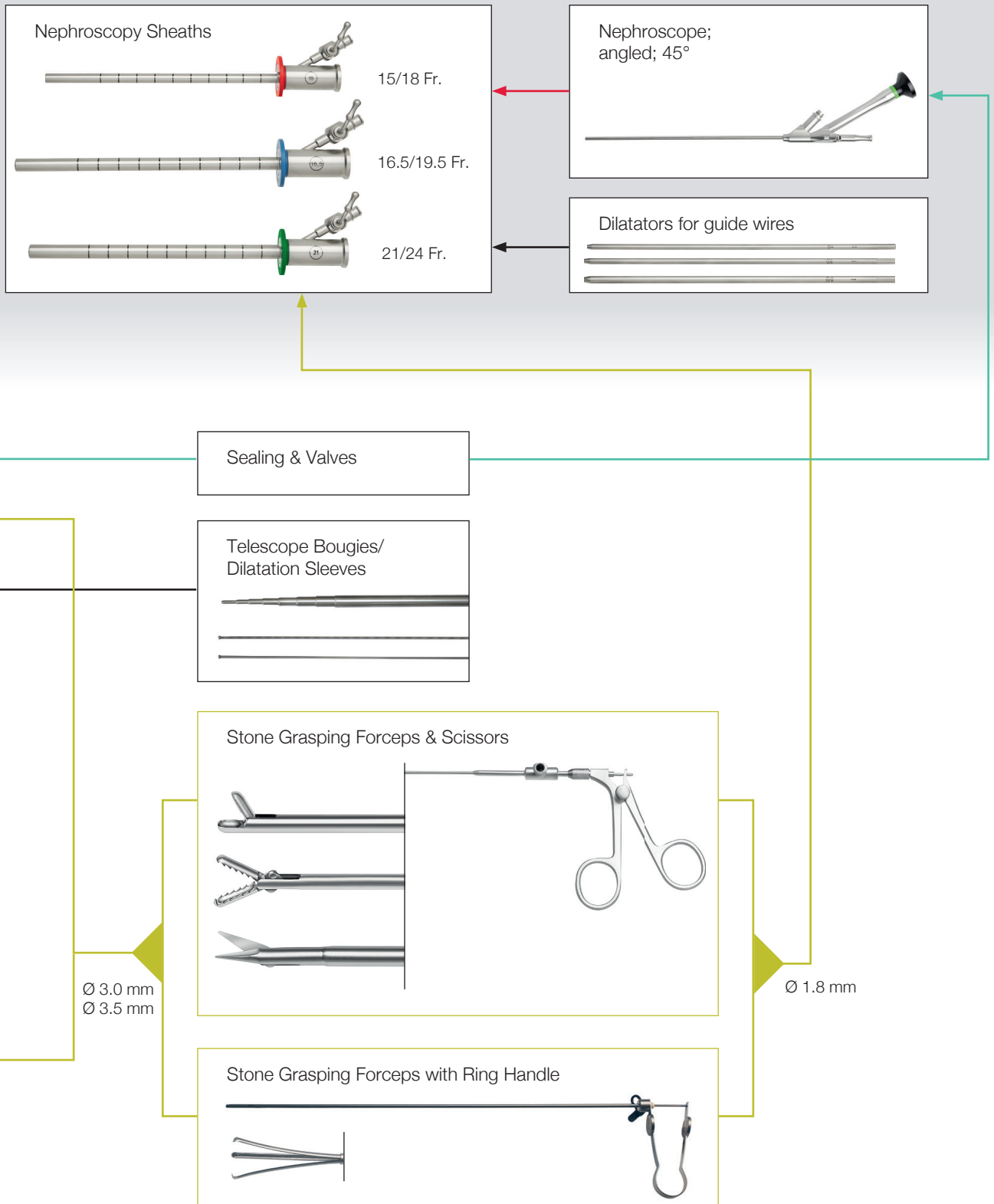



# TONTARRA NEPHROSCOPY

TONTARRA's Nephroscopy portfolio comprises supreme quality HD nephroscopes in combination with TONTARRA state-of-the-art nephroscopy sheaths, and a selected range of first-class accessories. All items are fully autoclavable.

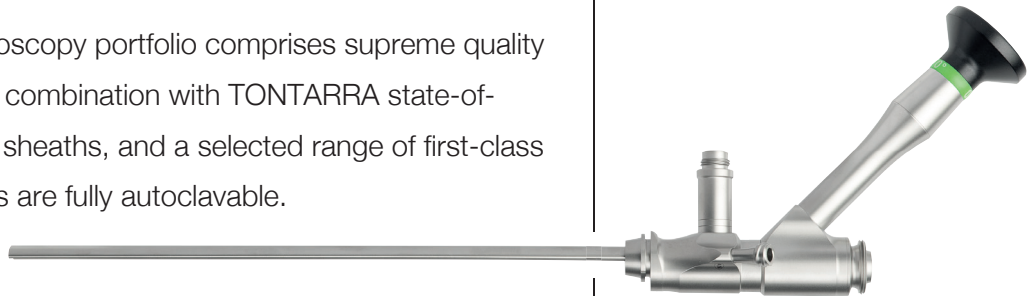

## CLASSIC NEPHROSCOPY

### ▶ HD Nephroscopes Ø 2.8 mm rod lens system

- Ø 5 mm working channel
- angled; 45° and double-angled 90°
- for 24 Fr. and 26 Fr. nephroscopy sheaths
- FL 200 mm and 250 mm

### ▶ HD Compact Nephroscopes Ø 1.8 mm rod lens system

- Ø 5 mm working channel
- angled; 45° and double-angled 90°
- for 23 Fr. nephroscopy sheaths
- FL 220 mm



- ▶ optical sharpness
- ▶ high resolution
- ▶ optimal colour synchronization

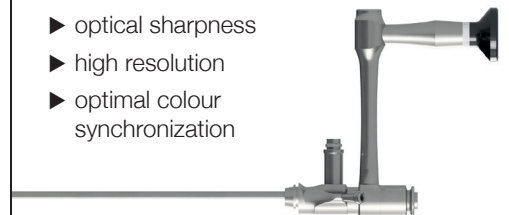

## MICRO INSTRUMENTS

for "classic" and mini-nephroscopy

Stone Grasping Forceps –  
micro-scissors – stone retrievers



## MINI NEPHROSCOPY

### ▶ HD Mini Compact Nephroscope with 40.000 Pixel image bundle

- Ø 2.2 mm working channel
- angled; 45°
- for mini-nephroscopy continuous flow sheaths:



## ACCESSORIES

for "classic" and mini-nephroscopy

### ▶ Dilatation



### ▶ Sealing

# NEPHROSCOPY

- ▶ HD Nephroscopes for 24/26 Fr. sheaths



24 Fr.  
26 Fr.

TONTARRA's Nephroscopes come with CAD-designed rod-lens system and objectives for maximum resolution, optimal sharpness and colorsynchronization, high quality fibers.

**FL**

Available function lengths:  
200 mm/250 mm

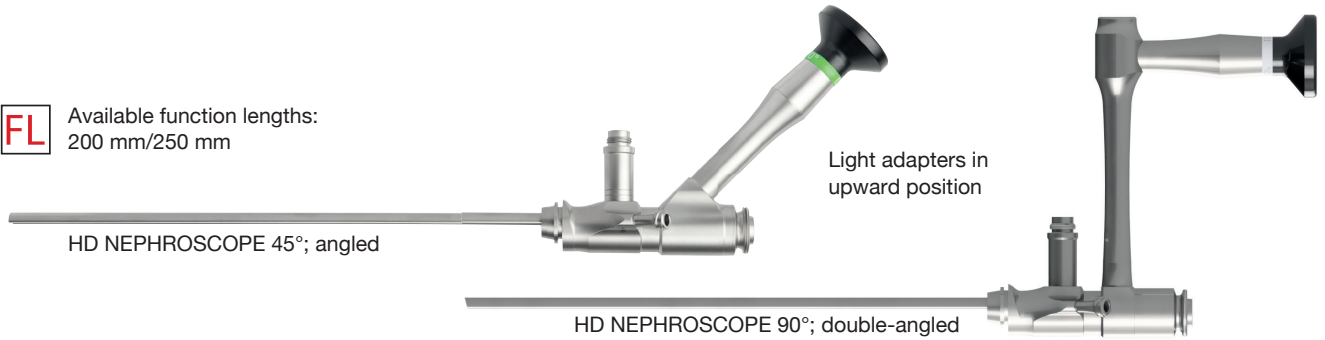

**HD NEPHROSCOPES** Ø 2.8 mm

▶ working channel Ø 5 mm

▶ 24 Fr. 26 Fr.

| Description                         | Function length | Art. No.   | Information                                                                                                                                                                                                                                                                  |
|-------------------------------------|-----------------|------------|------------------------------------------------------------------------------------------------------------------------------------------------------------------------------------------------------------------------------------------------------------------------------|
| HD NEPHROSCOPE<br>45° angled        | 200 mm          | 601-130-45 | <p>Direction of view <math>\alpha=15^\circ</math></p> <p>Field of view <math>\beta=70^\circ\pm 5^\circ</math></p> <p>Outer diameter 19 Fr.<br/>Polygone tube design</p> <p>Instrument port</p> <p>Optics</p> <p>Light fibres</p> <p>Fluid channel</p> <p>Working channel</p> |
| HD NEPHROSCOPE<br>45° angled        | 250 mm          | 601-140-45 |                                                                                                                                                                                                                                                                              |
| HD NEPHROSCOPE<br>90° double-angled | 200 mm          | 601-130-90 |                                                                                                                                                                                                                                                                              |
| HD NEPHROSCOPE<br>90° double-angled | 250 mm          | 601-140-90 |                                                                                                                                                                                                                                                                              |

- ▶ ACMI®-Wolf®-Storz® and Olympus® light port adapters & eye piece according to DIN58015
- ▶ Autoclavable
- ▶ Sapphires at the distal and proximal end

# NEPHROSCOPY

▶ ACCESSORIES for HD Nephroscopes (for 24/26 Fr. sheaths)



24 Fr.  
26 Fr.

**ACCESSORIES for HD Nephroscopes Ø 2.8 mm ▶ working channel Ø 5 mm**

| Description                                                                                                                                                                                           | Art. No.   | Information                                                                           |
|-------------------------------------------------------------------------------------------------------------------------------------------------------------------------------------------------------|------------|---------------------------------------------------------------------------------------|
| <b>Instrument Bridge</b><br>for Nephroscopes 601-130-45, 601-130-90, 601-140-45 and 601-140-90                                                                                                        | 601-120-12 |    |
| <b>DOME VALVE 072; Silicone transparent</b><br>for compact-nephroscopes 601-135-45 & 601-135-90 and nephroscopes 601-130-45, 601-130-90, 601-140-45; sheaths 18/22 & 24/26 Fr. systems. 10 pcs./unit  | 601-150-01 |    |
| <b>BACKUP SEAL 072; Silicone transparent</b><br>for compact-nephroscopes 601-135-45 & 601-135-90 and nephroscopes 601-130-45, 601-130-90, 601-140-45; sheaths 18/22 & 24/26 Fr. systems. 10 pcs./unit | 601-150-03 |    |
| <b>ADAPTER</b><br>for use of TONTARRA Nephroscopes (601-140-45 and 601-140-90) with 26 Fr. resectoscope outer sheath 630-209-06 or 630-209-07                                                         | 630-209-99 |  |
| <b>SILICONE SEAL Ø 20/2; blue</b><br>for use with nephroscopes 601-130-45, 601-130-90, 601-140-45 and 601-140-90. 10 pcs./unit                                                                        | 601-150-08 |  |
| <b>SILICONE SEAL Ø 15/1; blue</b><br>for use with instrument bridge 601-120-12, 10 pcs./unit                                                                                                          | 601-150-09 |  |



# NEPHROSCOPY

► Nephroscopy sheaths & obturators 24 Fr.



24 Fr.

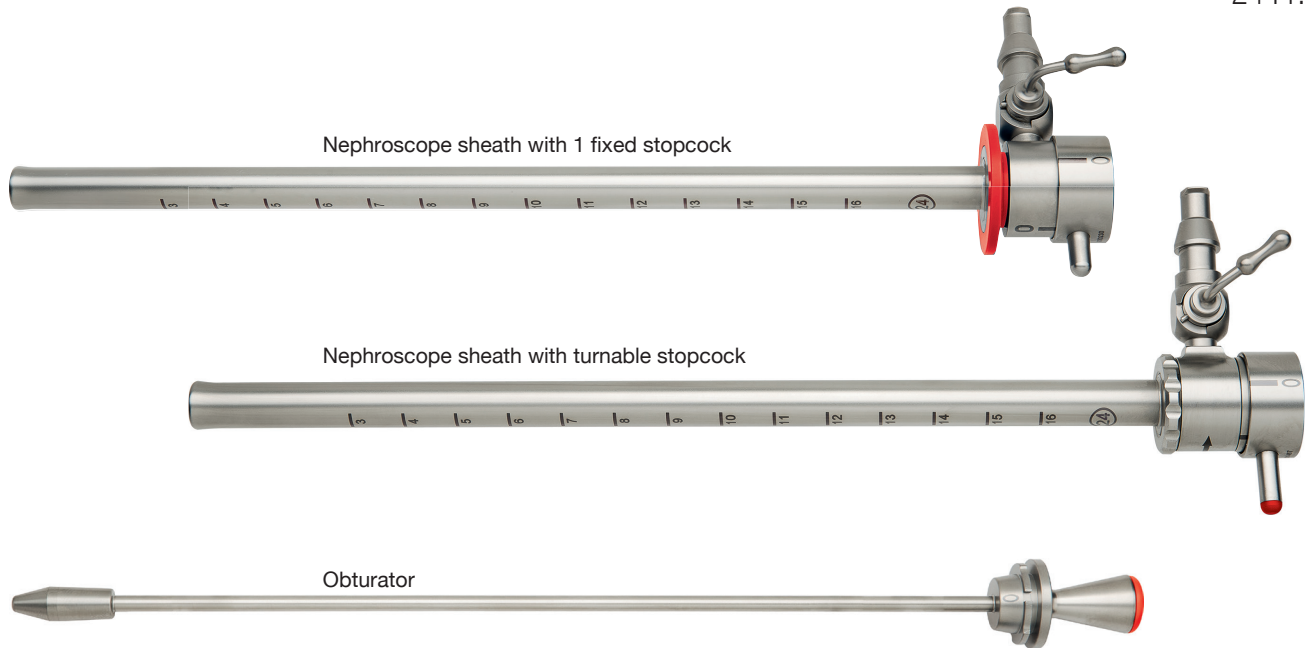

## NEPHROSCOPY SHEATH SYSTEM; 24 Fr.

| Description                                                                                                                               | ■ 200 mm   | ■ 250 mm   | □ 264 mm*  |
|-------------------------------------------------------------------------------------------------------------------------------------------|------------|------------|------------|
| NEPHROSCOPE SHEATH<br>1 x fixed stopcock                                                                                                  |            |            |            |
|                                                                                                                                           | 630-420-12 | 630-420-52 | 630-420-32 |
| NEPHROSCOPE SHEATH<br>Turnable stopcock                                                                                                   |            |            |            |
|                                                                                                                                           | 630-420-14 | 630-420-54 | 630-420-34 |
| OBTURATOR<br>hollow                                                                                                                       |            |            |            |
|                                                                                                                                           | 630-420-17 | 630-420-57 | 630-420-37 |
| Recommended nephroscopes: 601-130-45, 601-140-45, 601-130-90, 601-104-90<br>* Compatibility to K. Storz nephroscopes with "25 cm length". |            |            |            |

# NEPHROSCOPY

► Nephroscopy sheaths & obturators 26 Fr.



26 Fr.

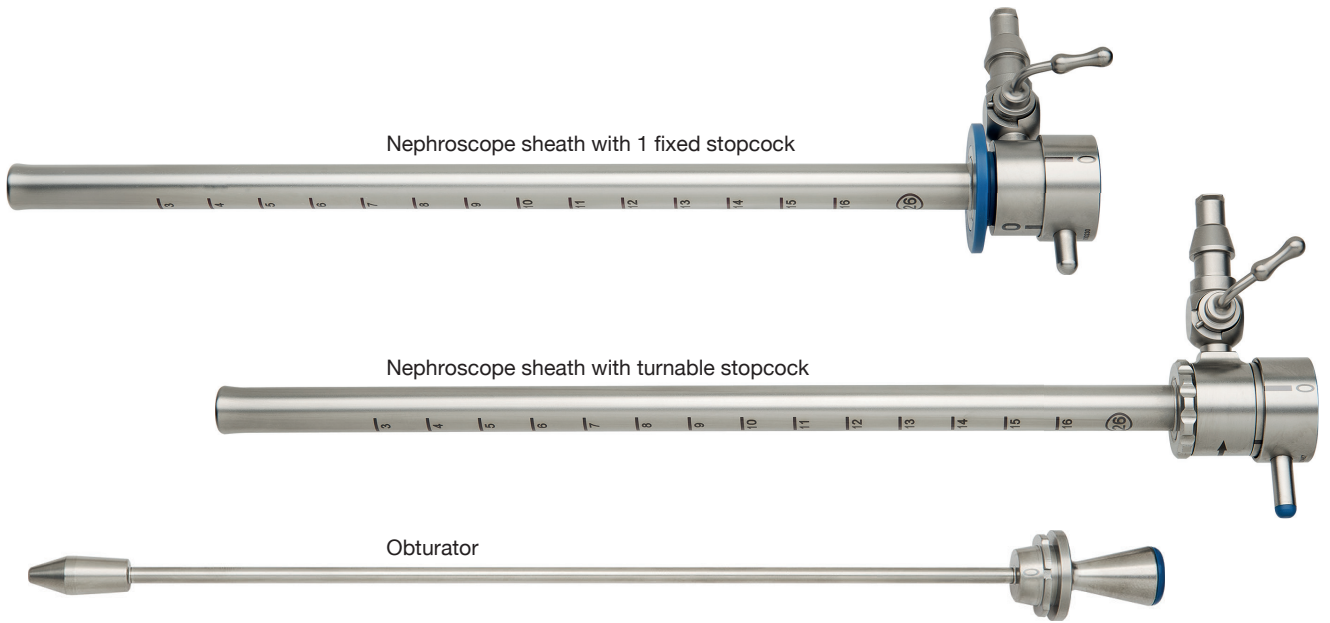

## NEPHROSCOPY SHEATH SYSTEM; 26 Fr.

| Description                                                                                                                               | ■ 200 mm   | ■ 250 mm   | ■ 264 mm*  |
|-------------------------------------------------------------------------------------------------------------------------------------------|------------|------------|------------|
| NEPHROSCOPE SHEATH<br>1 x fixed stopcock                                                                                                  |            |            |            |
|                                                                                                                                           | 630-420-22 |            |            |
| NEPHROSCOPE SHEATH<br>Turnable stopcock                                                                                                   |            |            |            |
|                                                                                                                                           | 630-420-24 | 630-420-64 | 630-420-44 |
| OBTURATOR<br>hollow                                                                                                                       |            |            |            |
|                                                                                                                                           | 630-420-27 | 630-420-67 | 630-420-47 |
| Recommended nephroscopes: 601-130-45, 601-140-45, 601-130-90, 601-104-90<br>* Compatibility to K. Storz nephroscopes with "25 cm length". |            |            |            |

# NEPHROSCOPY

- ▶ HD Nephroscopes for 23 Fr. sheaths



23 Fr.

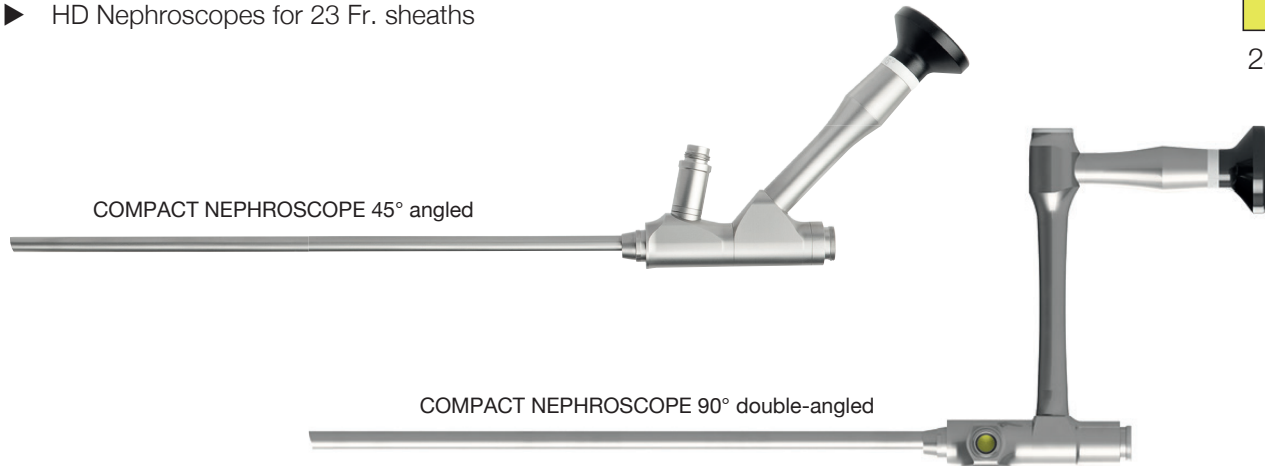

COMPACT NEPHROSCOPES Ø 1.8 mm ▶ working channel Ø 4.3 mm **FL** 220 mm ➔ 23 Fr.

| Description                                                                                                                                                                                      | Art. No.   | Information                                                                                                                                                                                                                     |
|--------------------------------------------------------------------------------------------------------------------------------------------------------------------------------------------------|------------|---------------------------------------------------------------------------------------------------------------------------------------------------------------------------------------------------------------------------------|
| COMPACT NEPHROSCOPE<br>45° angled                                                                                                                                                                | 601-135-45 | <p>Direction of view <math>\alpha=15^\circ</math></p> <p>Field of view <math>\beta=80^\circ \pm 5^\circ</math></p> <p>Optics</p> <p>Light fibres</p> <p>Working channel</p> <p>Outer diameter 18.8 Fr.<br/>Oval tube design</p> |
| COMPACT NEPHROSCOPE<br>90° double-angled                                                                                                                                                         | 601-135-90 |                                                                                                                                                                                                                                 |
| DOME VALVE 072; Silicone transparent<br><br>for compact-nephroscopes 601-135-45 & 601-135-90 and nephroscopes 601-130-45, 601-130-90, 601-140-45; sheaths 18/22 & 24/26 Fr. systems. 10 pc/unit  | 601-150-01 |                                                                                                                                                                                                                                 |
| BACKUP SEAL 072; Silicone transparent<br><br>for compact-nephroscopes 601-135-45 & 601-135-90 and nephroscopes 601-130-45, 601-130-90, 601-140-45; sheaths 18/22 & 24/26 Fr. systems. 10 pc/unit | 601-150-03 |                                                                                                                                                                                                                                 |
| Instrument Bridge<br><br>for Nephroscopes 601-135-45 and 601-135-90                                                                                                                              | 601-120-10 |                                                                                                                                                                                                                                 |
| SILICONE SEAL Ø 15/1; blue<br><br>for use with instrument bridge 601-120-12, 10 pcs./unit                                                                                                        | 601-150-09 |                                                                                                                                                                                                                                 |

- ▶ ACMI®-Wolf®-Storz® and Olympus® light port adapters & eye piece according to DIN58015
- ▶ Autoclavable
- ▶ Sapphires at the distal and proximal end

# NEPHROSCOPY

- ▶ Nephroscopy sheaths & obturators 23 Fr.
- ▶ Telescope Bougies for 23 Fr. / 24 Fr. / 26 Fr. Systems



23 Fr.

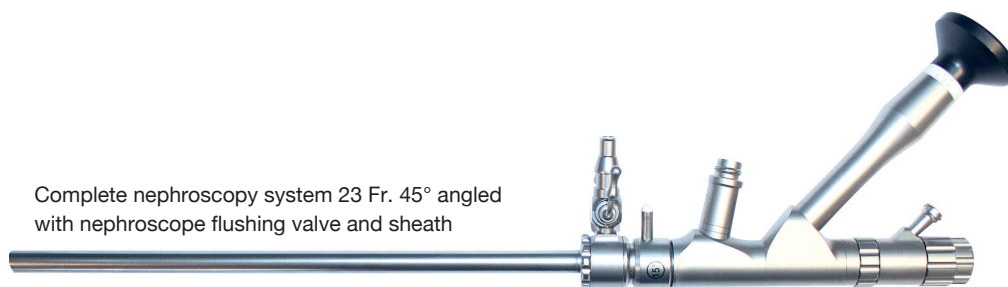



Complete nephroscopy system 23 Fr. 45° angled with nephroscope flushing valve and sheath

## NEPHROSCOPY SHEATH & OBTURATOR



▶ for 23 Fr.

**FL** 220 mm

| Description                                                                                                        | Art. No.   | Information                                                                                                                    |
|--------------------------------------------------------------------------------------------------------------------|------------|--------------------------------------------------------------------------------------------------------------------------------|
| <p>NEPHROSCOPY SHEATH 23 Fr.</p>  | 630-423-12 | for Compact-Nephrosopes 601-135-45 and 601-135-90; 15°                                                                         |
| <p>HOLLOW OBTURATOR</p>         | 630-423-17 | for nephroscopy sheath; 23 Fr. Art. No. 630-423-12; 15°; drilling Ø 1.4 mm; fits Compact-Nephrosopes 601-135-45 and 601-135-90 |

## TELESCOPE BOUGIES

▶ for 26 Fr./24 Fr./23 Fr. nephroscopy systems

| Description                                                                                                                         | Art. No.   | Information                                                                          |
|-------------------------------------------------------------------------------------------------------------------------------------|------------|--------------------------------------------------------------------------------------|
| <p><b>DILATATION SET</b></p> <p>Content: 1 x guide wire rigid + 1 x flexible, 1 x dilatation sleeve Ø 9, 12, 15, 18, 21, 24 Fr.</p> | 630-430-00 |  |
| The single sleeves are also available as spare parts:                                                                               |            |                                                                                      |
| Dilatation sleeve 9 Fr.                                                                                                             | 630-430-09 | Dilatation sleeve 18 Fr. 630-430-18                                                  |
| Dilatation sleeve 12 Fr.                                                                                                            | 630-430-12 | Dilatation sleeve 21 Fr. 630-430-21                                                  |
| Dilatation sleeve 15 Fr.                                                                                                            | 630-430-15 | Dilatation sleeve 24 Fr. 630-430-24                                                  |
| DILATATION SLEEVE 27 Fr.                                                                                                            | 630-430-27 |  |
| DILATATION SLEEVE 30 Fr.                                                                                                            | 630-430-30 |                                                                                      |
| HOLLOW GUIDE ROD rigid; for dilatation of the nephrostomy tract                                                                     | 630-432-05 |  |
| HOLLOW GUIDE ROD flexible; for dilatation of the nephrostomy tract                                                                  | 630-432-10 |                                                                                      |



## NEPHROSCOPY

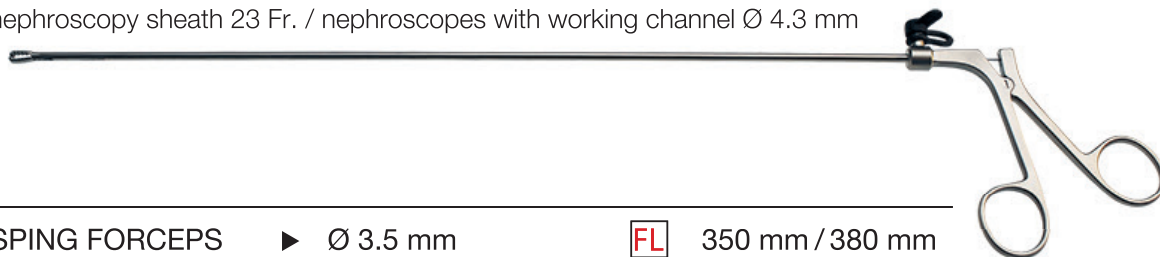

- ▶ Micro tools for percutaneous nephroscopy systems
  - For nephroscopy sheaths 24 & 26 Fr. / nephroscopes with working channel Ø 5.0 mm
  - For nephroscopy sheath 23 Fr. / nephroscopes with working channel Ø 4.3 mm

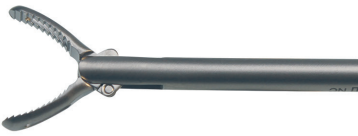

### STONE GRASPING FORCEPS ▶ Ø 3.5 mm FL 350 mm / 380 mm

| Description                                                                        | Art. No.      | Art. No.      |                  |
|------------------------------------------------------------------------------------|---------------|---------------|------------------|
| EXCISION FORCEPS                                                                   | <b>350 mm</b> | <b>380 mm</b> |                  |
|   | 630-450-35    | 630-450-38    | with ring handle |
| STONE GRASPING FORCEPS with fenestrated jaw parts                                  | 630-451-35    | 630-451-38    |                  |
|   | 630-452-35    | 630-452-38    |                  |
| STONE GRASPING FORCEPS for removal of larger stones                                |               |               |                  |
|  |               |               |                  |

### MICRO SCISSORS ▶ Ø 3.0 mm FL 400 mm

| Description                                      | Art. No.   |                                                                                     |
|--------------------------------------------------|------------|-------------------------------------------------------------------------------------|
| MICRO-SCISSORS; pointed; straight; single action | 630-461-30 |  |



### STONE GRASPING FORCEPS WITH RING HANDLE FL 380 mm / 400 mm

| Description                                                                                                          | Art. No.   |                                                                                                                      |
|----------------------------------------------------------------------------------------------------------------------|------------|----------------------------------------------------------------------------------------------------------------------|
| STONE GRASPER three-pronged; <ul style="list-style-type: none"> <li>▶ Ø 3.5 mm</li> <li>▶ FL 380 mm</li> </ul>       | 630-470-35 | <br>U-spring grip; self-closing |
| STONE GRASPER three-pronged; fine; <ul style="list-style-type: none"> <li>▶ Ø 3.0 mm</li> <li>▶ FL 400 mm</li> </ul> | 630-471-30 |                                                                                                                      |

# MINI NEPHROSCOPY

- ▶ HD Mini Compact Nephroscope



18 Fr.  
19.5 Fr.  
24 Fr.

The image transmission by the optical fiber bundle of 40.000 pixel results in brilliant high resolution quality and detailed contrast. With CAD-designed objective.



HD MINI COMPACT NEPHROSCOPE

## MINI COMPACT NEPHROSCOPE

- ▶ working channel Ø 2.2 mm

➡ 18 Fr./19.5 Fr./24 Fr.

FL 220 mm

| Description                                                                                                                                                                                                          | Art. No.   | Information                                                                                                                                                     |
|----------------------------------------------------------------------------------------------------------------------------------------------------------------------------------------------------------------------|------------|-----------------------------------------------------------------------------------------------------------------------------------------------------------------|
| HD MINI COMPACT NEPHROSCOPE;<br>direction of view 0°; 40.000 pixels;<br>working length 220mm; shaft Ø 4,0mm (12 Fr.);<br>working channel Ø 2,2mm (6,6 Fr.),<br>with fix instrument bridge<br>and integrated stopcock | 601-145-30 | <p>Direction of view <math>\alpha=0^\circ</math></p> <p>Optic</p> <p>Light fibres</p> <p>Working channel</p> <p>Round tube design<br/>Outer diameter 12 Fr.</p> |
| STOP COCK<br>Ø 3.5 mm; black;<br>for mini-nephroscope 601-145-30                                                                                                                                                     | 601-150-11 |                                                                                                                                                                 |
| SPRING CAP<br>for mini-nephroscope 601-145-30                                                                                                                                                                        | 601-150-10 |                                                                                                                                                                 |
| DOME VALVE 052<br>for mini-nephroscope 601-145-30;<br>Silicone transparent;<br>Material: ML151VMQ; 10 pcs./unit                                                                                                      | 601-160-02 |                                                                                                                                                                 |
| BACKUP SEAL 052<br>for mini-nephroscope 601-145-30;<br>Silicone transparent;<br>Material: ML151VMQ; 10 pcs./unit                                                                                                     | 601-160-03 |                                                                                                                                                                 |

- ▶ ACMI®-Wolf®-Storz® and Olympus® light port adapters & eye piece according to DIN58015
- ▶ Autoclavable







**MINI NEPHROSCOPY**

- ▶ Nephroscopy Sheaths
- ▶ Dilators



15/18.5 Fr.  
16.5/19.5 Fr.  
21/24 Fr.

**NEPHROSCOPY SHEATHS**

| Description                                                                                       | Size          | Colour code | Art. No.   |                                                                                      |
|---------------------------------------------------------------------------------------------------|---------------|-------------|------------|--------------------------------------------------------------------------------------|
| NEPHROSCOPY SHEATH                                                                                | 15/18 Fr.     | ■ red       | 630-435-15 |   |
| NEPHROSCOPY SHEATH                                                                                | 16.5/19,5 Fr. | ■ blue      | 630-435-20 |   |
| NEPHROSCOPY SHEATH                                                                                | 21/24 Fr.     | ■ green     | 630-435-25 |  |
| SEALING APPLICATOR; 2 parts in connection with sheath and plunger                                 |               |             | 630-435-30 |  |
| DILATATOR for guide wire;<br>for 15/18 Fr. sheath; Length 300 mm                                  |               |             | 630-435-35 |  |
| DILATATOR - 2 CHANNELS for introduction of guide wire;<br>for 16.5/19.5 Fr. sheath; Length 300 mm |               |             | 630-435-40 |  |
| DILATATOR - 2 CHANNELS for introduction of guide wire;<br>for 21/24 Fr. sheath; Length 300 mm     |               |             | 630-435-45 |  |

# MINI-NEPHROSCOPY

▶ Micro tools for percutaneous nephroscopes

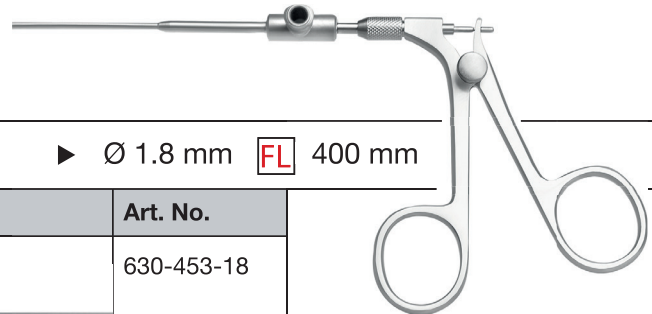

## STONE GRASPING FORCEPS & MICRO SCISSORS ▶ Ø 1.8 mm **FL** 400 mm

| Description                                                                                 | Art. No.   |
|---------------------------------------------------------------------------------------------|------------|
| GRASPING FORCEPS<br>cup; serrated;<br>Ø 1.8 mm; FL 400 mm;<br>with irrigation adapter       | 630-453-18 |
| ALLIGATOR FORCEPS<br>Ø 1.8 mm; FL 400 mm;<br>with irrigation adapter                        | 630-454-18 |
| PE FORCEPS<br>cup; sharp; single action;<br>Ø 1.8 mm; FL 400 mm;<br>with irrigation adapter | 630-455-18 |
| SCISSORS<br>pointed tips; single action;<br>Ø 1.6 mm; FL 400 mm;<br>with irrigation adapter | 630-461-16 |

with ring handle

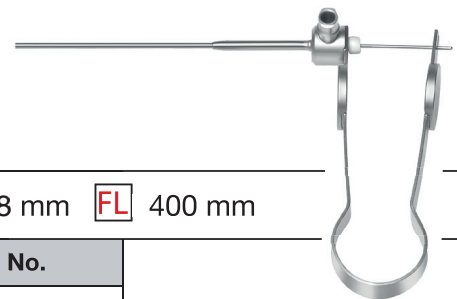

## STONE GRASPING FORCEPS WITH RING HANDLE ▶ Ø 1.8 mm **FL** 400 mm

| Description                                                                              | Art. No.   |
|------------------------------------------------------------------------------------------|------------|
| 3 PRONGS RETRIEVER<br>semi-rigid; Ø 1.8 mm; FL 400 mm;<br>with firmly welded spring grip | 630-471-18 |

U-spring grip; self-closing

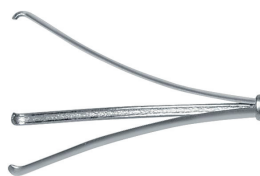





# PEDIATRIC UROLOGY



- ◀ 13 Fr.
- ◀ 11 Fr.
- ◀ 9/9.5 Fr.
- ◀ 7.5 Fr.

**PEDIATRIC UROLOGY**

► Schematic overview



PEDIATRIC UROLOGY

**RESECTOSCOPY**

Resectoscopy Sheaths  
13 Fr. / 11 Fr. / 9 Fr.



Obturator

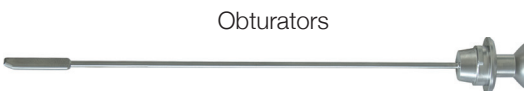

HF Electrodes  
13 Fr. / 11 Fr. / 9 Fr.



Working Elements

- 13 Fr.
- 11 Fr.
- 9 Fr.

Telescope Bridge

- 13 Fr.
- 11 Fr.
- 9 Fr.

3 Fr. Button Electrode



**CYSTOSCOPY**

Cysto-Urethroscope Sheaths  
13 Fr. / 11 Fr. / 9.5 Fr.



Obturator

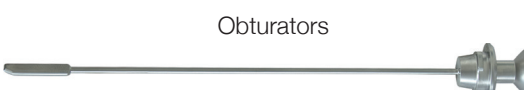

Telescope Bridge  
13 Fr. system only

Albarran Deflector  
13 Fr. system only

3 Fr. Biopsy & Grasping Forceps





Systems and components for Ø 2.7 mm telescopes  
 Systems and components for Ø 2.0 mm telescopes  
 Systems and components for Ø 1.9 mm telescopes

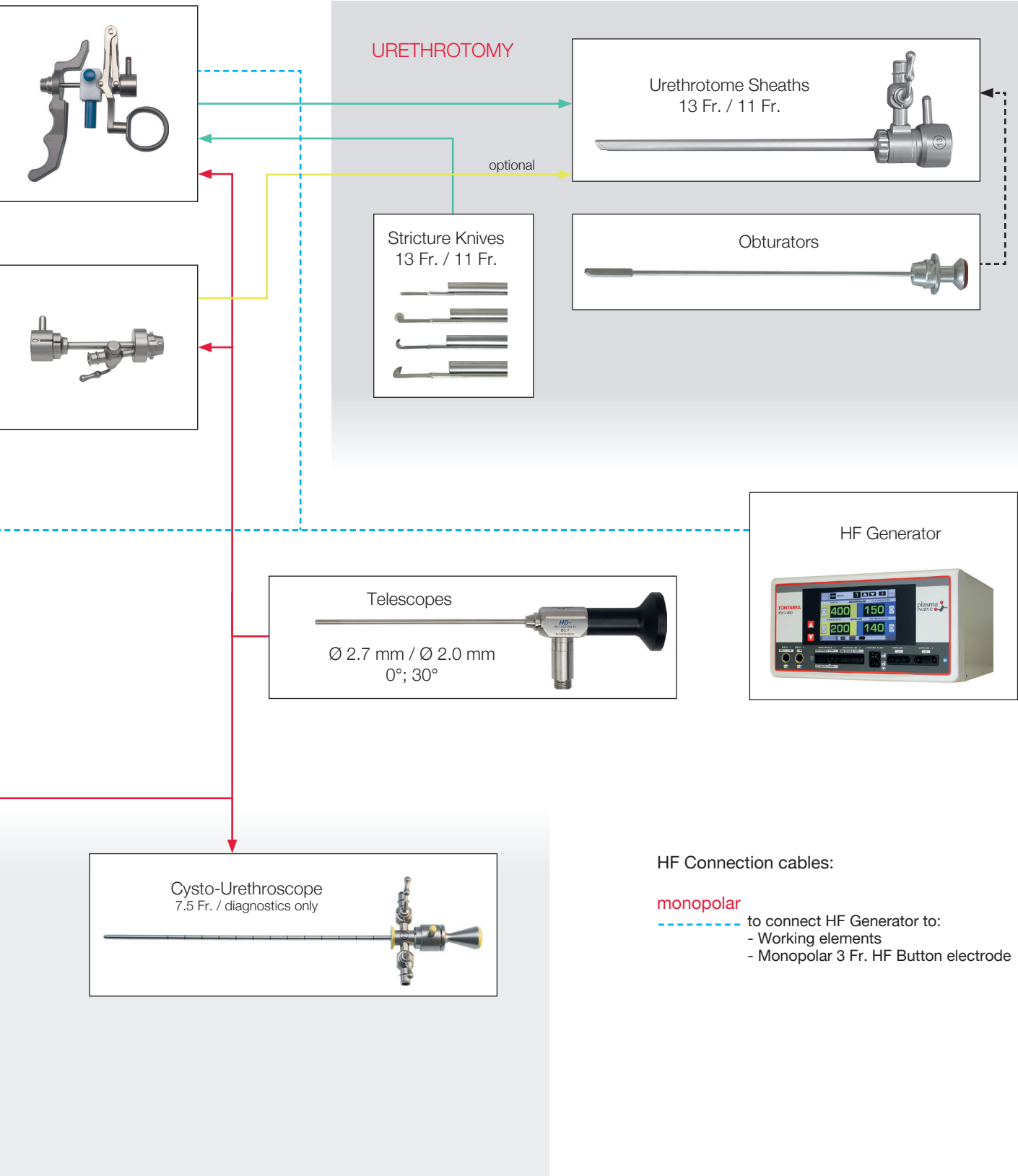

HF Connection cables:

**monopolar**

- to connect HF Generator to:
- Working elements
- Monopolar 3 Fr. HF Button electrode



# PEDIATRIC UROLOGY

TONTARRA's extensive program for pediatric urology reflects our exceptional manufacturing skills, which are required when wanting to create optimally functioning miniaturized endoscopic instruments.

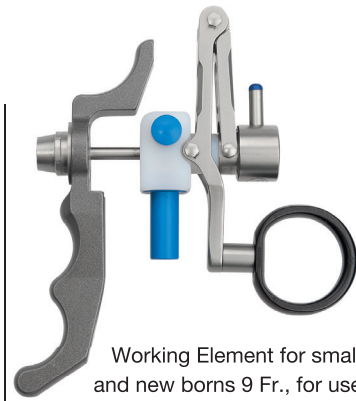

Working Element for small children and newborns 9 Fr., for use in **resectoscopy** and **urethrotomy**.

## TONTARRA'S PORTFOLIO INCLUDES

### FOR Ø 2.7 mm TELESCOPES:

▶ SYSTEMS FOR 13 Fr. ( ■ )

- Cysto-Urethroscopy
- Resectoscopy
- Urethrotomy

### FOR Ø 2.0 mm TELESCOPES:

▶ SYSTEMS FOR ( ■ | ■ | ■ )

- Cysto-Urethroscopy (11 & 9.5 Fr.)
- Cysto-Urethroscopy (7.5 Fr.)
- Resectoscopy (11 & 9 Fr.)
- Urethrotomy (11 Fr.)

▶ RANGE OF HF ELECTRODES

for all TONTARRA pediatric resectoscopy systems ( ■ | ■ | ■ )



- 7.5 Fr. ■ yellow
- 9/9.5 Fr. ■ blue
- 11 Fr. ■ green
- 13 Fr. ■ red



Mini sizes, maximum convenience

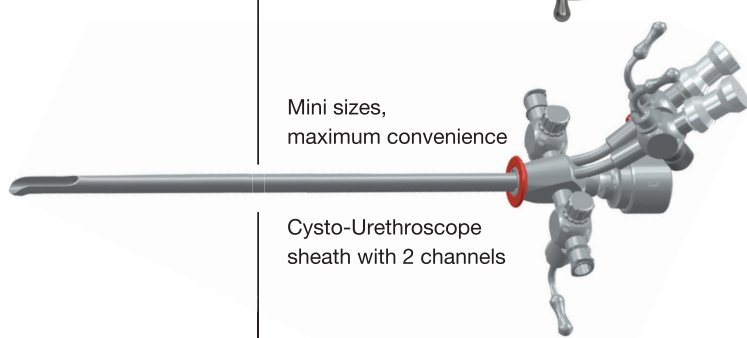

Cysto-Urethroscope sheath with 2 channels

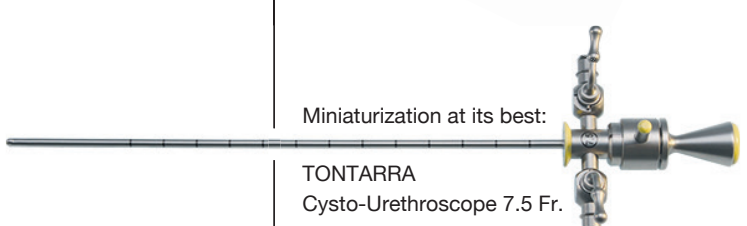

Miniaturization at its best:

TONTARRA Cysto-Urethroscope 7.5 Fr.







# PEDIATRIC CYSTO-URETHROSCOPY

▶ 13 Fr. for Ø 2.7 mm/187 mm telescopes

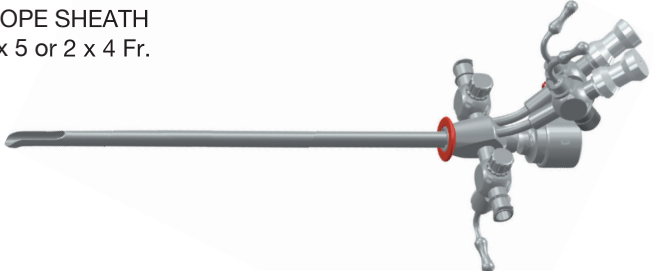

13 Fr.

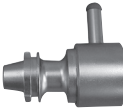
## CYSTO-URETHROSCOPE SYSTEM ▶ 13 Fr. ▶ Ø 2.7 mm/187 mm telescopes



| Description                                                                                                                                                    | Art. No.   | Information                                                                                        |
|----------------------------------------------------------------------------------------------------------------------------------------------------------------|------------|----------------------------------------------------------------------------------------------------|
| <b>CYSTO-URETHROSCOPE SHEATH</b><br>2 stopcocks; 1 instrument channel 3 Fr.  | 630-502-13 |                                                                                                    |
| <b>CYSTO-URETHROSCOPE SHEATH</b><br>with 2 CHANNELS; 1 x 5 or 2 x 4 Fr.      | 630-500-14 |                                                                                                    |
| <b>STANDARD OBTURATOR</b>                                                  | 630-500-15 |                                                                                                    |
| <b>TELESCOPE BRIDGE</b><br>only for Art. No. 630-500-13                    | 630-500-20 |  601-203-30HD |
| <b>ALBARRAN DEFLECTOR</b><br>only for Art. No. 630-500-13                  | 630-500-25 |                                                                                                    |

## MICRO INSTRUMENTATION ▶ 3 Fr.

▶ 3 Fr.



13 Fr./11 Fr./9.5 Fr.

|                                                                                     |                                                                                              |                                                                                       |
|-------------------------------------------------------------------------------------|----------------------------------------------------------------------------------------------|---------------------------------------------------------------------------------------|
|  |          |  |
| <b>BIOPSY FORCEPS</b><br>flexible; oval; double action<br>FL 280 mm<br>583-110-10   | <b>GRASPING FORCEPS</b><br>flexible; alligator jaw; double action<br>FL 280 mm<br>583-160-10 | <b>BUTTON ELECTRODE *</b><br>flexible HF electrode<br>FL 470 mm<br>582-510-03         |

\* Overview of cables in chapter „Accessories“.



## PEDIATRIC CYSTO-URETHROSCOPY

▶ 11 Fr., 9.5 Fr. & 7.5 Fr. Systems for Ø 2.0 mm telescopes





11 Fr.  
9.5 Fr.  
7.5 Fr.

### CYSTO-URETHROSCOPE SYSTEM ▶ 11 Fr. & 9.5 Fr. ▶ Ø 2.0 mm / 187 mm telescopes

| Description                                                                                                                                                                  | Size / Color code / Art. No. |                | Information                                                                                                |
|------------------------------------------------------------------------------------------------------------------------------------------------------------------------------|------------------------------|----------------|------------------------------------------------------------------------------------------------------------|
|                                                                                                                                                                              | 11 Fr. ■ green               | 9.5 Fr. ■ blue |                                                                                                            |
| CYSTO-URETHROSCOPE SHEATH<br>2 stopcocks; 1 instrument channel 3 Fr.; without obturator<br> | 630-507-11                   | 630-507-09     |  Ø 2.0 mm<br>601-102-00 |
| STANDARD OBTURATOR<br>                                                                      | 630-505-12                   | 630-505-10     |                                                                                                            |

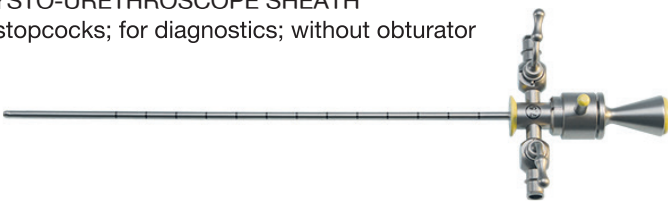
### CYSTO-URETHROSCOPE SYSTEM ▶ 7.5 Fr. ▶ Ø 2.0 mm / 187 mm telescopes

| Description                                                                                                                                                         | Size / Color code / Art. No. |  | Information                                                                                                  |
|---------------------------------------------------------------------------------------------------------------------------------------------------------------------|------------------------------|--|--------------------------------------------------------------------------------------------------------------|
|                                                                                                                                                                     | 7.5 Fr. ■ yellow             |  |                                                                                                              |
| CYSTO-URETHROSCOPE SHEATH<br>2 stopcocks; for diagnostics; without obturator<br> | 630-507-07                   |  |  Ø 2.0 mm<br>601-102-00 |
| OBTURATOR for Art. No. 630-507-07                                                                                                                                   | 630-505-07                   |  |                                                                                                              |









## PEDIATRIC RESECTOSCOPY

- ▶ 13 Fr. Resectoscopy System for Ø 2.7 mm/187 mm telescopes
- ▶ 11 Fr. Resectoscopy System for Ø 2.0 mm/187 mm telescopes



13 Fr.  
11 Fr.

### RESECTOSCOPY SHEATH SYSTEM ▶ 13 Fr. ▶ 11 Fr.

| Description                                                                                                                                                                                                                             | Size / Color code / Art. No.                                                                                    |                                                                                                                 | Information                                                                                                                                                                              |
|-----------------------------------------------------------------------------------------------------------------------------------------------------------------------------------------------------------------------------------------|-----------------------------------------------------------------------------------------------------------------|-----------------------------------------------------------------------------------------------------------------|------------------------------------------------------------------------------------------------------------------------------------------------------------------------------------------|
|                                                                                                                                                                                                                                         | 13 Fr. ■ red                                                                                                    | 11 Fr. ■ green                                                                                                  |                                                                                                                                                                                          |
| <p><b>Monopolar WORKING ELEMENT</b> passive cutting;<br/>for resectoscopy and urethrotomy;<br/>for small children and new borns</p>                    | 630-510-20                                                                                                      |                                                                                                                 |  13 Fr.<br> 11 Fr. |
| <p>RESECTOSCOPY SHEATH<br/>1 turnable stopcock</p>                                                                                                    | 630-510-13                                                                                                      | 630-511-13                                                                                                      |                                                                                                                                                                                          |
| <p>STANDARD OBTURATOR</p>                                                                                                                            | 630-510-14                                                                                                      | 630-511-14                                                                                                      |                                                                                                                                                                                          |
| <p>TELESCOPE BRIDGE<br/>only for use with the resectoscopic<br/>sheaths of this system; and<br/>urethrotome sheaths<br/>630-515-13 / 630-516-13</p>  | 630-510-25                                                                                                      | 630-511-25                                                                                                      |                                                                                                                                                                                          |
| <p>Telescope recommendation – TONTARRA HD telescopes</p>                                                                                                                                                                                |  0° Ø 2.7 mm<br>601-203-00HD |  0° Ø 2.0 mm<br>601-102-00 |                                                                                                                                                                                          |





**PEDIATRIC RESECTOSCOPY**

▶ 9 Fr. Resectoscopy System for Ø 2.0 mm/187 mm telescopes

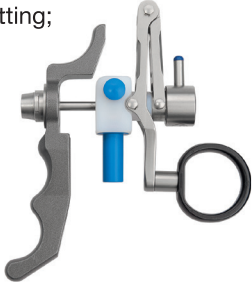

9 Fr.

▶ 9 Fr. RESECTOSCOPY SYSTEM ▶ for Ø 2.0 mm/187 mm telescopes

| Description                                                                                                                                                                 | Size / Color code / Art. No. | Information                                                                                                   |
|-----------------------------------------------------------------------------------------------------------------------------------------------------------------------------|------------------------------|---------------------------------------------------------------------------------------------------------------|
|                                                                                                                                                                             | 9 Fr. ■ blue                 |                                                                                                               |
| <p><b>Monopolar</b> WORKING ELEMENT passive cutting; for small children and new borns</p>  | 630-512-09                   |  0° Ø 2.0 mm<br>601-102-00 |
| <p>RESECTOSCOPY SHEATH 9 Fr. with rotatable stopcock</p>                                  | 630-512-13                   |                                                                                                               |
| <p>STANDARD OBTURATOR</p>                                                                | 630-512-14                   |                                                                                                               |
| <p>TELESCOPE BRIDGE</p>                                                                  | 630-230-09                   |                                                                                                               |



## PEDIATRIC RESECTOSCOPY

- ▶ 13 Fr. Resectoscopy System for Ø 2.7 mm/187 mm telescopes
- ▶ 9 Fr./11 Fr. Resectoscopy System for Ø 2.0 mm/187 mm telescopes



13 Fr.  
11 Fr.  
9 Fr.

### MONOPOLAR HF ELECTRODES

13 Fr./11 Fr./9 Fr.

- ▶ Reusable electrodes for use with **monopolar** current and non-conductive solution (Sorbitol, Mannitol, Glycine)

| Description                 |  | 13 Fr.                      | 11 Fr.                    | 9 Fr.                     |
|-----------------------------|--|-----------------------------|---------------------------|---------------------------|
|                             |  | red                         | green                     | blue                      |
| LOOP ELECTRODE<br>▶ size 1  |  | 630-510-50                  | 630-511-50                | 630-512-50                |
| LOOPS ELECTRODE<br>▶ size 2 |  | 630-510-55                  | 630-511-55                | 630-512-55                |
| BALL ELECTRODE              |  | 630-510-60                  | 630-511-60                | 630-512-60                |
| KNIFE ELECTRODE             |  | 630-510-65                  | 630-511-65                | 630-512-65                |
| HOOK ELECTRODE              |  | 630-510-70                  | 630-511-70                | 630-512-70                |
| Telescope recommendation    |  | 0° Ø 2.7 mm<br>601-203-30HD | 0° Ø 2.0 mm<br>601-102-00 | 0° Ø 2.0 mm<br>601-102-00 |

### HF CONNECTION CABLES; **MONOPOLAR** for working elements and flexible electrodes

|                                                                                                                                                                                      |                                                                     |                                     |                                                                                           |
|--------------------------------------------------------------------------------------------------------------------------------------------------------------------------------------|---------------------------------------------------------------------|-------------------------------------|-------------------------------------------------------------------------------------------|
| <p><b>Available for following units:</b></p> <p>Erbe/Storz; Ø 5.0 mm<br/>Valleylab; Conmed Ø 8.0 mm; Bowa; 8.0 mm<br/>TONTARRA mod. PWT-400; Equipment with banana plug Ø 4.0 mm</p> | <p><b>3.0 m</b></p> <p>582-531-02<br/>582-532-03<br/>582-533-04</p> | <p></p> <p>Plug instrument side</p> | <p>For further information and pictures see overview cables in chapter „Accessories“.</p> |
|--------------------------------------------------------------------------------------------------------------------------------------------------------------------------------------|---------------------------------------------------------------------|-------------------------------------|-------------------------------------------------------------------------------------------|

## PEDIATRIC VISUAL URETHROTOMY

- ▶ 13 Fr. Visual Urethrotome System for Ø 2.7 mm telescopes
- ▶ 11 Fr. Visual Urethrotome System for Ø 2.0 mm telescopes



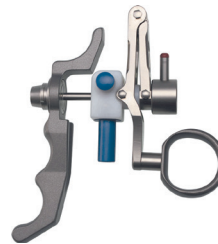

13 Fr.  
11 Fr.

The TONTARRA WORKING ELEMENT is designed for use in **resectoscopy and urethrotomy** for small children and newborns.







Art. No. 630-510-20  
WORKING ELEMENT  
passive cutting

### URETHROTOME SYSTEM ▶ 13 Fr. ▶ 11 Fr.

| Description                                                                                                                                                                                                            | Size / Color code / Art. No. |                |
|------------------------------------------------------------------------------------------------------------------------------------------------------------------------------------------------------------------------|------------------------------|----------------|
|                                                                                                                                                                                                                        | 13 Fr. ■ red                 | 11 Fr. ■ green |
| URETHROTOME SHEATH<br>2 turnable stopcocks; without obturator<br>                                                                   | 630-515-13                   | 630-516-13     |
| STANDARD OBTURATOR<br>                                                                                                             | 630-515-14                   | 630-516-14     |
| TELESCOPE BRIDGE<br>only for use with the urethrotom sheaths of this system; and resectoscopic sheaths 630-510-13 / 630-511-13<br> | 630-510-25                   | 630-511-25     |

### STRICTURE KNIVES 13 Fr./11 Fr.

| Description                                                                                                                 | 13 Fr.     | 11 Fr.     |  |
|-----------------------------------------------------------------------------------------------------------------------------|------------|------------|--|
| STRICTURE KNIFE<br>▶ straight<br>      | 630-515-50 | 630-516-50 |  |
| STRICTURE KNIFE<br>▶ round<br>         | 630-515-55 | 630-516-55 |  |
| STRICTURE KNIFE<br>▶ sickle shaped<br> | 630-515-60 | 630-516-60 |  |
| STRICTURE KNIFE<br>▶ hook shaped<br>   | 630-515-65 | 630-516-65 |  |



# HF GENERATOR & CONNECTION CABLES



# HF GENERATOR **PLASMA WAVE**

▶ PWT-400



## HF Generator for electrical surgery **PWT-400** **SMART - SAFE - POWERFUL**

Many options – one device.



### SMART

- ▶ Multi disciplinary use
- ▶ Optimized modes for various clinical applications
- ▶ 99 storage positions for application-specific programs/profiles
  - All presets can be adapted individually
  - Customizable program settings and descriptions

### SAFE

- ▶ Self-test during system start and permanent auto check during use
- ▶ Current leakage monitoring
- ▶ Neutral electrode monitoring:
  - use of small neutral electrodes for pediatrics or neonates possible
  - use of split neutral electrodes possible

### POWERFUL

- ▶ Accurate, smooth incisions and effective coagulation due to optimized presettings
- ▶ 14 monopolar and bipolar cutting modes and 10 coagulation modes; self-adjusting of output power

### HYBRID RESECTOSCOPY SYSTEMS

- ▶ **A perfect match!** The Plasma Wave HF generator and the TONTARRA bipolar resectoscopy system are perfectly synchronized to each other. Excellent resection effect due to precisely adjusted parameters.

For technical data & more details please ask for our Plasma Wave brochure.



- ▶ Suitable for monopolar and bipolar applications
- ▶ The unit features the simultaneous use of two monopolar handles
- ▶ Compatible with one or two twin foot-switches
- ▶ Intuitive menu navigation via touch display



Twin foot-switch

#### HF connection cables for PWT-400

HF-connection cables **monopolar**

3 m: Art. No. 582-533-04



HF-connection cables **bipolar**, to connect:

- working element to HF generator  
3 m: Art. No. 287-215-30BR

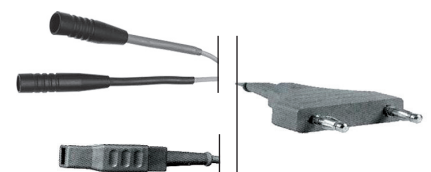



- bipolar electrodes to HF generator  
3 m: Art. No. 287-215-30  
5 m: Art. No. 287-215-50

# HF GENERATOR & HF CONNECTION CABLES



- ▶ HF Unit Plasma Wave PWT 400

## HF UNIT PLASMA WAVE





| Description                                                                                                                                                                                                                      | Art. No.            |
|----------------------------------------------------------------------------------------------------------------------------------------------------------------------------------------------------------------------------------|---------------------|
| PWT-400 Plasma Wave; HF generator for electrical surgery<br>  | 540-280-50(PWT-400) |
| TWIN FOOT-SWITCH<br>                                                                                                                           | 540-284-50          |

## HF CONNECTION CABLES





- ▶ Monopolar HF connection cables

### HF CONNECTION CABLES; **MONOPOLAR**

- ▶ to connect working elements to HF generator; **monopolar** mode for resectoscopy
- ▶ to connect flexible **monopolar** HF electrodes to HF generator

| Available for following units:                              | 3.0 m      | Instrument-side                                                                      | Unit-side                                                                             |
|-------------------------------------------------------------|------------|--------------------------------------------------------------------------------------|---------------------------------------------------------------------------------------|
| Erbe/Storz; Ø 5.0 mm                                        | 582-531-02 |  |  |
| Valleylab, Conmed; Bowa; Ø 8.0 mm                           | 582-532-03 |                                                                                      |  |
| TONTARRA mod. PWT-400; Equipment with banana plug; Ø 4.0 mm | 582-533-04 |                                                                                      |  |

### HF CONNECTION CABLES; NEUTRAL ELECTRODES

| Description                                             | length | Art. No.   | Electrode side                                                                        | Unit-Side                                                                             |
|---------------------------------------------------------|--------|------------|---------------------------------------------------------------------------------------|---------------------------------------------------------------------------------------|
| TONTARRA mod. PWT-400 for reusable Neutral Electrodes   | 4.5 m  | 289-215-45 |   |  |
| TONTARRA mod. PWT-400 for single-use Neutral Electrodes | 4.5 m  | 289-025-45 |  |  |

## HF CONNECTION CABLES

► Bipolar HF connection cables



HF CONNECTION CABLES; **BIPOLAR** ► to connect working element to HF generator;  
**bipolar** mode for resectoscopy

| Description                                                                    | Length | Art. No.     | Instrument-side | Unit-side |
|--------------------------------------------------------------------------------|--------|--------------|-----------------|-----------|
| Erbe mod. ICC/ACC; Storz                                                       | 3.0 m  | 287-200-30BR |                 |           |
| Berchthold/Martin mod. Maxium                                                  | 3.0 m  | 287-205-30BR |                 |           |
| TONTARRA mod. PWT-400; International Models; 2-pins                            | 3.0 m  | 287-215-30BR |                 |           |
| Covidien mod. ForceTriad™; Valleylab™ FT10                                     | 3.0 m  | 287-240-30BR |                 |           |
| Erbe mod. VIO300D with multi-contact connector; Karl Storz mod. Autocon II 400 | 3.0 m  | 287-220-30BR |                 |           |
| Erbe mod. VIO 3 with MF-U socket                                               | 4.5 m  | 287-235-30BR |                 |           |
| Emed-HF mod. Spectrum                                                          | 4.0 m  | 287-225-30BR |                 |           |
| Bowa mod. ARC 350 & 400                                                        | 4.5 m  | 287-230-30BR |                 |           |

HF CONNECTION CABLES; **BIPOLAR** ► to connect semi-flexible **bipolar** HF electrodes to HF generator

| Available for following units:                                      | 3.0 m      | 5.0 m      | Instrument-side  | Unit-side |
|---------------------------------------------------------------------|------------|------------|------------------|-----------|
| Erbe, Storz/unit side round plug                                    | 287-200-30 | 287-200-50 | <p>flat plug</p> |           |
| Berchthold/ Martin/unit side round plug                             | 287-205-30 | 287-205-50 |                  |           |
| Us-Models; 2-pins/unit side banana plugs; Ø 4.0 mm                  | 287-210-30 | 287-210-50 |                  |           |
| TONTARRA PWT-400; Valleylab; International Models; 2 pins; Ø 4.0 mm | 287-215-30 | 287-215-50 |                  |           |



# ACCESSORIES

**ACCESSORIES**



► Dilating Bougies; Catheter Introduction; Penis Clamps





**VAN BUREN; DILATING BOUGIES** ► 275 mm

| Size   | Art. No.   | Size   | Art. No.   | Size   | Art. No.   |
|--------|------------|--------|------------|--------|------------|
| 8 Fr.  | 170-620-08 | 18 Fr. | 170-620-18 | 28 Fr. | 170-620-28 |
| 10 Fr. | 170-620-10 | 20 Fr. | 170-620-20 | 30 Fr. | 170-620-30 |
| 12 Fr. | 170-620-12 | 22 Fr. | 170-620-22 | 32 Fr. | 170-620-32 |
| 14 Fr. | 170-620-14 | 24 Fr. | 170-620-24 | 34 Fr. | 170-620-34 |
| 16 Fr. | 170-620-16 | 26 Fr. | 170-620-26 | 36 Fr. | 170-620-36 |

**GUYON-CATHETER INTRODUCING INSTRUMENTS**

| Curved; 35 cm (13.8")                                                               | Straight; 39 cm (15.4")                                                              |
|-------------------------------------------------------------------------------------|--------------------------------------------------------------------------------------|
|  |  |
| 170-268-36                                                                          | 170-268-39                                                                           |

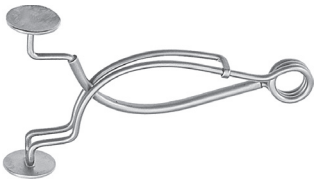
**PENIS CLAMPS**

| STOCKMANN; 8 cm (3.2")                                                              | STRAUSS; 11 cm (4.4")                                                                |
|-------------------------------------------------------------------------------------|--------------------------------------------------------------------------------------|
|  |  |
| 170-345-08                                                                          | 170-349-11                                                                           |







## ACCESSORIES

- ▶ Evacuators; Bladder Syringes; Tubing Connectors & Sealing caps







### ELLIK EVACUATOR & SHEATH CONNECTIONS

| Description                                                                                                 |                                                                                     | Art. No.     |
|-------------------------------------------------------------------------------------------------------------|-------------------------------------------------------------------------------------|--------------|
| ELLIK EVACUATOR<br>without connection; glass<br>Content: Glass 582-400-20; Ball 582-400-25                  |  | 582-400-05   |
| SHEATH CONNECTION<br>with locking<br>Conus length: 36 mm; Tube length: 115 mm                               |  | 582-400-10   |
| SHEATH CONNECTION for ELLIK evacuator<br>with <b>Quick Lock</b><br>Conus length: 36 mm; Tube length: 115 mm |  | 582-400-10QL |
| SHEATH CONNECTION with cone<br>Conus length: 32.7 mm; Tube length: 115 mm                                   |  | 582-400-15   |

### BLADDER SYRINGES

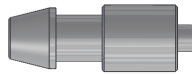
| Size   | With sheath connection                                                              | Glass cylinder only                                            |
|--------|-------------------------------------------------------------------------------------|----------------------------------------------------------------|
|        |  | For your convenience we also offer the cylinder as spare part. |
| 50 ml  | 582-410-05                                                                          | 582-410-05Z                                                    |
| 75 ml  | 582-410-07                                                                          | 582-410-07Z                                                    |
| 100 ml | 582-410-10                                                                          | 582-410-10Z                                                    |
| 150 ml | 582-410-15                                                                          | 582-410-15Z                                                    |

### TUBING CONNECTORS & SEALING CAPS

| Description                                                                            |                                                                                                | Art. No.   |
|----------------------------------------------------------------------------------------|------------------------------------------------------------------------------------------------|------------|
| LuerLock TUBING CONNECTOR                                                              |           | 087-940-01 |
| LuerLock TUBING CONNECTOR with STOPCOCK                                                |           | 087-940-02 |
| SEALING CAP for instrument channel<br>with special WATER STOP VALVE;<br>10 pc. per box | 3-10 Fr.  | 499-198-00 |
| SEALING CAP for instrument channel; 10 pc. per box                                     |           | 499-199-00 |
| SHAFT SEALING ADAPTER for use in female urethroscopy                                   |           | 582-090-00 |

**ACCESSORIES**

► Light Guide Cables & Connectors



FIBER LIGHT GUIDE CABLES Ø 3.5 mm ► Stability & resistance for a long life time  
 ► without connectors

| Description                                         | Standard Cold Light Line                        | HTT High Temperature Technology Line                                                                                                                                                                                                                                                                           | HP High Performance Line |  |
|-----------------------------------------------------|-------------------------------------------------|----------------------------------------------------------------------------------------------------------------------------------------------------------------------------------------------------------------------------------------------------------------------------------------------------------------|--------------------------|--|
| <b>Cold light sources</b>                           | <b>HALOGEN</b><br><i>careful w/Xenon light!</i> | for all cold light sources (excellent light transmission)<br>optimized for <b>XENON</b> optimized for <b>LED</b>                                                                                                                                                                                               |                          |  |
| <b>Sizes</b>                                        | <b>Art. No.'s</b>                               |                                                                                                                                                                                                                                                                                                                |                          |  |
| Ø 3.5 x 1800 mm Length                              | 540-803-18                                      | 540-813-18                                                                                                                                                                                                                                                                                                     | 540-823-18               |  |
| Ø 3.5 x 2300 mm Length                              | 540-803-23                                      | 540-813-23                                                                                                                                                                                                                                                                                                     | 540-823-23               |  |
| Ø 3.5 x 3000 mm Length                              | 540-803-30                                      | 540-813-30                                                                                                                                                                                                                                                                                                     | 540-823-30               |  |
| Ø 3.5 x 5000 mm Length                              | 540-803-50                                      | 540-813-50                                                                                                                                                                                                                                                                                                     | 540-823-50               |  |
| Ø 2.5 x 1800 mm Length                              |                                                 | 540-812-18                                                                                                                                                                                                                                                                                                     | 540-822-18               |  |
| Ø 2.5 x 2300 mm Length                              |                                                 | 540-812-23                                                                                                                                                                                                                                                                                                     | 540-822-23               |  |
| Ø 2.5 x 3000 mm Length                              |                                                 | 540-812-30                                                                                                                                                                                                                                                                                                     | 540-822-30               |  |
| Ø 2.5 x 5000 mm Length                              |                                                 | 540-812-50                                                                                                                                                                                                                                                                                                     | 540-822-50               |  |
| <b>Tube colours</b><br>The Standard colour is grey. | Only available in grey                          | ● LL (Lilac)    ● YW (Yellow)    ● GN (Green)<br>Colour Coding made easy:<br>If you want to order one of the shown colours Lilac, Yellow or Green, please indicate the corresponding extensions shown in the column to the right (f.e. for a green cable add „GN“, the article number then reads 540-XXX-XXGN) |                          |  |
| Colour of introduction piece                        | Black                                           | Blue                                                                                                                                                                                                                                                                                                           | White                    |  |

For further information please ask for our Light Guide Cable brochure.

**LIGHT CABLE CONNECTORS**

| Projector-Side (light input) |            |  | Telescope-Side (light output)         |            |  |
|------------------------------|------------|--|---------------------------------------|------------|--|
| Storz/Aesculap               | 540-890-02 |  | TONTARRA/Storz/Aesculap/Olympus (old) | 540-880-02 |  |
| Olympus/ACMI                 | 540-890-10 |  |                                       | 540-880-04 |  |
| Olympus new (switch)         | 540-890-14 |  | Olympus new                           | 540-880-04 |  |
| Wolf                         | 540-890-04 |  | Wolf/HSW/Dyonics snap                 | 540-880-13 |  |
| ACMI/British/Codman          | 540-890-01 |  | ACMI/British/Codman                   | 540-880-01 |  |

**LIGHT GUIDE ADAPTERS [spare parts]**

| Description                          | Art. No.   |  | Description                                      | Art. No.   |  |
|--------------------------------------|------------|--|--------------------------------------------------|------------|--|
| RICHARD WOLF<br>Light guide adapter  | 601-900-10 |  | Universal<br>Light guide adapter<br>► 90° angled | 601-900-15 |  |
| STORZ/OLYMPUS<br>Light guide adapter | 601-900-00 |  |                                                  |            |  |



## ACCESSORIES

- ▶ Maintenance; storage & sterilization
- ▶ Protection

### MAINTENANCE; STORAGE & STERILIZATION

| Description                                                                                                                      | Art. No.        |
|----------------------------------------------------------------------------------------------------------------------------------|-----------------|
| <b>TAP &amp; STOPCOCK LUBRICANT</b><br>▶ special grease for surgical instruments (especially for stopcocks)<br>▶ 5 gram per tube | 582-095-00      |
| <b>INSTRUMENT OIL</b><br>▶ 500 ml                                                                                                | DRSO/00-108-005 |
| <b>POLISHING PASTE FOR ENDOSCOPES</b><br>▶ 5 pcs.                                                                                | 601-900-20      |

### PROTECTION



| Description                                                                                                           | Art. No.                    |
|-----------------------------------------------------------------------------------------------------------------------|-----------------------------|
| <b>PROTECTING SLEEVE FOR ALL TELESCOPES</b><br>▶ easy handling;<br>▶ up to Ø 5.5 mm<br>▶ reusable<br>▶ Plastic sleeve | 590-000-01<br>(10 pcs./box) |
| <b>PROTECTING SLEEVE for ELECTRODES</b><br>for storage and sterilization<br>for up to 8 electrodes, reusable          | 590-000-03                  |

**ACCESSORIES**

▶ Wire Baskets

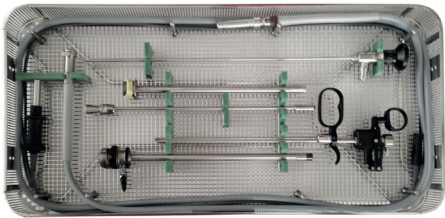
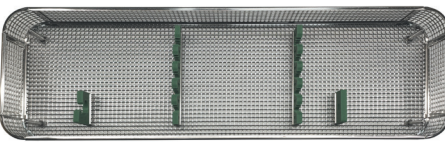

**WIRE BASKETS**

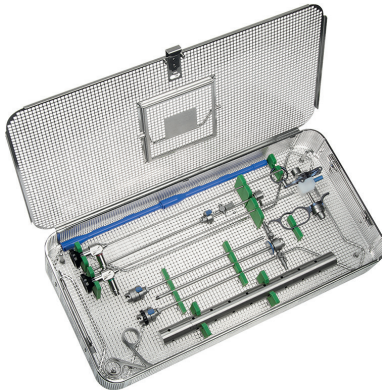
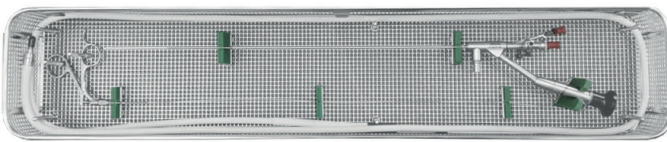
| Description                                                                                                                                                | Art. No.            |
|------------------------------------------------------------------------------------------------------------------------------------------------------------|---------------------|
| <p>WIRE BASKET WITH LID FOR RESECTOSCOPY SETS<br/>▶ 480x240x50 mm</p>    | <p>CBMO/74TRP</p>   |
| <p>WIRE BASKET WITH LID FOR SCOPE AND SHEATHS<br/>▶ 480x150x50 mm</p>    | <p>CBMO/66/1RES</p> |
| <p>WIRE BASKET WITH LID FOR SCOPE AND SHEATHS<br/>▶ 480x150x50 mm</p>  | <p>CBMO/66/1K</p>   |
| <p>WIRE BASKET FOR GUBBINI SYSTEM<br/>▶ 480x245x80 mm</p>              | <p>582-150-60GU</p> |
| <p>WIRE BASKET FOR URETERORENOSCOPES;<br/>▶ 750x150x80 mm</p>          | <p>260-690-01</p>   |

ACCESSORIES

- ▶ Stopcock handle and nut



SPARE PART SET: STOPCOCK HANDLE AND NUT

| Description                                                                   | Art. No.   |
|-------------------------------------------------------------------------------|------------|
| SPARE PART SET <b>MIDDLE</b> :<br>stopcock handle and nut for stopcock handle | 087-940-03 |
| SPARE PART SET <b>BIG</b> :<br>stopcock handle and nut for stopcock handle    | 087-940-04 |





**INDEX**

|                     |     |               |     |               |    |                |    |               |    |
|---------------------|-----|---------------|-----|---------------|----|----------------|----|---------------|----|
| 087-940-01          | 97  | 540-822-50    | 98  | 582-533-04    | 42 | 583-410-16LL   | 66 | 601-104-70HD  | 16 |
| 087-940-02          | 97  | 540-823-18    | 98  | 582-533-04    | 89 | 583-410-16LLA  | 66 | 601-104-70HD2 | 6  |
| 087-940-03          | 101 | 540-823-23    | 98  | 582-533-04    | 93 | 583-460-12     | 66 | 601-104-70HD2 | 15 |
| 087-940-04          | 101 | 540-823-30    | 98  | 582-610-02    | 64 | 583-460-12A    | 66 | 601-104-70HD2 | 16 |
| 087-940-07          | 7   | 540-823-50    | 98  | 582-610-03    | 64 | 583-460-12LL   | 66 | 601-104-70HD2 | 18 |
| 170-268-36          | 96  | 582-090-00    | 97  | 582-610-05    | 64 | 583-460-12LLA  | 66 | 601-110-05    | 7  |
| 170-268-39          | 96  | 582-095-00    | 99  | 582-720-00    | 62 | 583-460-16     | 66 | 601-110-05    | 64 |
| 170-345-08          | 96  | 582-150-02GUB | 27  | 582-720-01    | 62 | 583-460-16A    | 66 | 601-110-10    | 7  |
| 170-349-11          | 96  | 582-150-02GUB | 47  | 582-720-02    | 62 | 583-460-16LL   | 66 | 601-110-10    | 64 |
| 170-620-08          | 96  | 582-150-60GU  | 100 | 582-720-03    | 62 | 583-460-16LLA  | 66 | 601-110-15    | 7  |
| 170-620-10          | 96  | 582-180-00B   | 47  | 582-720-05    | 62 | 583-472-12     | 66 | 601-110-15    | 64 |
| 170-620-12          | 96  | 582-180-01B   | 47  | 583-010-16    | 17 | 583-472-12A    | 66 | 601-110-20    | 7  |
| 170-620-14          | 96  | 582-180-15    | 46  | 583-010-16A   | 17 | 583-472-12LL   | 66 | 601-110-20    | 64 |
| 170-620-16          | 96  | 582-180-21    | 45  | 583-010-23    | 17 | 583-472-12LLA  | 66 | 601-120-10    | 75 |
| 170-620-18          | 96  | 582-180-22    | 45  | 583-010-23A   | 17 | 583-472-16     | 66 | 601-120-12    | 72 |
| 170-620-20          | 96  | 582-180-23    | 46  | 583-010-30    | 17 | 583-472-16A    | 66 | 601-130-45    | 71 |
| 170-620-22          | 96  | 582-180-23    | 55  | 583-010-30A   | 17 | 583-472-16LL   | 66 | 601-130-90    | 71 |
| 170-620-24          | 96  | 582-180-24    | 45  | 583-020-16    | 17 | 583-472-16LLA  | 66 | 601-135-45    | 75 |
| 170-620-26          | 96  | 582-180-24    | 55  | 583-020-16A   | 17 | 583-473-12     | 65 | 601-135-90    | 75 |
| 170-620-28          | 96  | 582-180-26    | 45  | 583-020-23    | 17 | 583-473-12A    | 65 | 601-140-45    | 71 |
| 170-620-30          | 96  | 582-180-26    | 55  | 583-020-23A   | 17 | *583-480-12    | 66 | 601-140-90    | 71 |
| 170-620-32          | 96  | 582-180-38    | 45  | 583-020-30    | 17 | *583-480-12A   | 66 | 601-145-30    | 78 |
| 170-620-34          | 96  | 582-180-39    | 45  | 583-020-30A   | 17 | *583-480-12LL  | 66 | 601-150-01    | 72 |
| 170-620-36          | 96  | 582-180-40B   | 47  | 583-030-16    | 17 | *583-480-12LLA | 66 | 601-150-01    | 75 |
| 260-690-01          | 100 | 582-180-40B-S | 47  | 583-030-16A   | 17 | 583-480-16     | 66 | 601-150-03    | 72 |
| 287-200-30          | 94  | 582-180-41B   | 47  | 583-030-23    | 17 | 583-480-16A    | 66 | 601-150-03    | 75 |
| 287-200-30          | 22  | 582-180-41B-S | 47  | 583-030-23A   | 17 | 583-480-16LL   | 66 | 601-150-08    | 72 |
| 287-200-30BR        | 94  | 582-180-42B   | 47  | 583-030-30    | 17 | 583-480-16LLA  | 66 | 601-150-09    | 72 |
| 287-200-50          | 94  | 582-180-42B-S | 47  | 583-030-30A   | 17 | 583-490-16     | 66 | 601-150-09    | 75 |
| 287-200-50          | 22  | 582-180-43B   | 47  | 583-050-16    | 17 | 583-490-16A    | 66 | 601-150-10    | 78 |
| 287-205-30          | 94  | 582-180-43B-S | 47  | 583-050-16A   | 17 | 583-490-16LL   | 66 | 601-150-11    | 78 |
| 287-205-30          | 22  | 582-180-44B   | 47  | 583-050-23    | 17 | 583-490-16LLA  | 66 | 601-160-02    | 78 |
| 287-205-30BR        | 94  | 582-400-05    | 97  | 583-050-23A   | 17 | 590-000-01     | 99 | 601-160-03    | 78 |
| 287-205-50          | 94  | 582-400-10    | 97  | 583-050-30    | 17 | 590-000-03     | 99 | 601-203-00HD  | 6  |
| 287-205-50          | 22  | 582-400-10QL  | 97  | 583-050-30A   | 17 | 601-102-00     | 6  | 601-203-30HD  | 6  |
| 287-210-30          | 94  | 582-400-15    | 97  | 583-060-16    | 17 | 601-102-30     | 6  | 601-900-20    | 99 |
| 287-210-30          | 22  | 582-410-05    | 97  | 583-060-16A   | 17 | 601-103-00HD2  | 6  | 630-012-17    | 13 |
| 287-210-50          | 94  | 582-410-05Z   | 97  | 583-060-23    | 17 | 601-103-00HD2  | 54 | 630-012-19    | 13 |
| 287-210-50          | 22  | 582-410-07    | 97  | 583-060-23A   | 17 | 601-103-12HD2  | 6  | 630-012-21    | 13 |
| 287-215-30          | 22  | 582-410-07Z   | 97  | 583-060-30    | 17 | 601-103-12HD2  | 54 | 630-012-23    | 13 |
| 287-215-30          | 94  | 582-410-10    | 97  | 583-060-30A   | 17 | 601-103-30HD2  | 6  | 630-012-25    | 13 |
| 287-215-30BR        | 94  | 582-410-10Z   | 97  | 583-070-16    | 17 | 601-103-30HD2  | 20 | 630-017-17    | 13 |
| 287-215-50          | 22  | 582-410-15    | 97  | 583-070-16A   | 17 | 601-103-30HD2  | 54 | 630-017-19    | 13 |
| 287-215-50          | 94  | 582-410-15Z   | 97  | 583-110-10    | 85 | 601-103-30HD2  | 19 | 630-017-21    | 13 |
| 287-220-30BR        | 94  | 582-510-03    | 22  | 583-160-10    | 85 | 601-103-70     | 6  | 630-017-23    | 13 |
| 287-225-30BR        | 94  | 582-510-03    | 85  | 583-310-10    | 65 | 601-104-00HD   | 6  | 630-017-25    | 13 |
| 287-230-30BR        | 94  | 582-510-05    | 22  | 583-310-10A   | 65 | 601-104-00HD   | 16 | 630-020-17    | 13 |
| 287-235-30BR        | 94  | 582-510-07    | 22  | 583-310-16    | 65 | 601-104-00HD2  | 6  | 630-020-19    | 13 |
| 287-240-30BR        | 94  | 582-511-05    | 22  | 583-310-16A   | 65 | 601-104-00HD2  | 16 | 630-020-21    | 13 |
| 289-025-45          | 93  | 582-511-07    | 22  | 583-320-16    | 65 | 601-104-00HD2  | 60 | 630-020-23    | 13 |
| 289-215-45          | 93  | 582-514-05    | 22  | 583-320-16A   | 65 | 601-104-12HD   | 6  | 630-020-25    | 13 |
| 499-196-00          | 7   | 582-514-07    | 22  | 583-350-16    | 65 | 601-104-12HD   | 16 | 630-025-17    | 13 |
| 499-198-00          | 97  | 582-515-05    | 22  | 583-350-16A   | 65 | 601-104-12HD   | 16 | 630-025-19    | 13 |
| 499-199-00          | 97  | 582-516-05    | 22  | 583-360-10    | 65 | 601-104-12HD2  | 6  | 630-025-21    | 13 |
| 540-280-50(PWT-400) | 93  | 582-517-05    | 22  | 583-360-10A   | 65 | 601-104-12HD2  | 16 | 630-025-23    | 13 |
| 540-284-50          | 93  | 582-518-05    | 22  | 583-360-16    | 65 | 601-104-12HD2  | 16 | 630-025-25    | 13 |
| 540-803-18          | 98  | 582-531-02    | 22  | 583-360-16A   | 65 | 601-104-12HD2  | 19 | 630-030-00    | 14 |
| 540-803-23          | 98  | 582-531-02    | 34  | 583-370-12    | 65 | 601-104-12HD2  | 18 | 630-030-01    | 14 |
| 540-803-30          | 98  | 582-531-02    | 36  | 583-370-12A   | 65 | 601-104-30HD   | 6  | 630-030-02    | 14 |
| 540-803-50          | 98  | 582-531-02    | 42  | 583-370-16    | 65 | 601-104-30HD   | 13 | 630-030-21    | 15 |
| 540-812-18          | 98  | 582-531-02    | 89  | 583-370-16A   | 65 | 601-104-30HD   | 16 | 630-030-22    | 15 |
| 540-812-23          | 98  | 582-531-02    | 93  | 583-380-12    | 65 | 601-104-30HD   | 16 | 630-035-00    | 16 |
| 540-812-30          | 98  | 582-532-03    | 22  | 583-380-12A   | 65 | 601-104-30HD   | 18 | 630-035-05    | 16 |
| 540-812-50          | 98  | 582-532-03    | 34  | 583-380-16    | 65 | 601-104-30HD2  | 6  | 630-035-10    | 16 |
| 540-813-18          | 98  | 582-532-03    | 36  | 583-380-16A   | 65 | 601-104-30HD2  | 13 | 630-035-13    | 16 |
| 540-813-23          | 98  | 582-532-03    | 42  | 583-410-12    | 66 | 601-104-30HD2  | 16 | 630-035-15    | 16 |
| 540-813-30          | 98  | 582-532-03    | 89  | 583-410-12A   | 66 | 601-104-30HD2  | 16 | 630-035-20    | 16 |
| 540-813-50          | 98  | 582-532-03    | 93  | 583-410-12LL  | 66 | 601-104-30HD2  | 18 | 630-035-25    | 16 |
| 540-822-18          | 98  | 582-533-04    | 22  | 583-410-12LLA | 66 | 601-104-30HD2  | 15 | 630-035-25    | 29 |
| 540-822-23          | 98  | 582-533-04    | 34  | 583-410-16    | 66 | 601-104-70HD   | 6  | 630-035-25    | 35 |
| 540-822-30          | 98  | 582-533-04    | 36  | 583-410-16A   | 66 | 601-104-70HD   | 15 | 630-035-30    | 18 |



**INDEX**

|             |    |               |    |              |    |                 |     |
|-------------|----|---------------|----|--------------|----|-----------------|-----|
| 630-035-35  | 18 | 630-240-00    | 33 | 630-352-55   | 38 | 630-500-14      | 85  |
| 630-035-85  | 18 | 630-240-00B   | 30 | 630-352-90   | 38 | 630-500-15      | 85  |
| 630-040-00  | 19 | 630-240-00BPI | 30 | 630-400-21   | 60 | 630-500-20      | 85  |
| 630-040-05  | 19 | 630-240-00B-S | 30 | 630-400-30   | 60 | 630-500-25      | 85  |
| 630-040-10  | 19 | 630-240-01    | 36 | 630-400-40   | 60 | 630-502-13      | 85  |
| 630-040-15  | 19 | 630-240-05    | 33 | 630-400-50   | 60 | 630-505-07      | 86  |
| 630-042-01  | 20 | 630-240-05B   | 30 | 630-400-60   | 60 | 630-505-10      | 86  |
| 630-042-02  | 20 | 630-240-06    | 36 | 630-400-65   | 60 | 630-505-12      | 86  |
| 630-042-15  | 20 | 630-240-10    | 33 | 630-400-70   | 60 | 630-507-07      | 86  |
| 630-042-20  | 20 | 630-240-10B   | 30 | 630-401-15   | 61 | 630-507-09      | 86  |
| 630-042-21  | 21 | 630-240-10B-S | 30 | 630-401-26   | 61 | 630-507-11      | 86  |
| 630-042-22  | 21 | 630-240-11    | 36 | 630-401-30   | 61 | 630-510-13      | 87  |
| 630-042-23  | 21 | 630-240-15    | 33 | 630-405-05   | 61 | 630-510-14      | 87  |
| 630-042-25  | 21 | 630-240-15B   | 30 | 630-405-10   | 61 | 630-510-20      | 87  |
| 630-045-23  | 50 | 630-240-15B-S | 30 | 630-405-15   | 61 | 630-510-25      | 87  |
| 630-045-30  | 50 | 630-240-20    | 33 | 630-405-20   | 61 | 630-510-25      | 90  |
| 630-045-35  | 50 | 630-240-20B   | 30 | 630-405-60BU | 61 | 630-510-50      | 89  |
| 630-045-40  | 50 | 630-240-25    | 33 | 630-406-01   | 61 | 630-510-55      | 89  |
| 630-046-08  | 52 | 630-240-25B   | 30 | 630-406-06   | 61 | 630-510-60      | 89  |
| 630-046-12  | 52 | 630-240-30    | 33 | 630-406-16   | 61 | 630-510-65      | 89  |
| 630-047-08  | 52 | 630-240-30B   | 30 | 630-420-12   | 73 | 630-510-70      | 89  |
| 630-047-12  | 52 | 630-240-35    | 33 | 630-420-14   | 73 | 630-511-13      | 87  |
| 630-047-25  | 52 | 630-240-35B   | 30 | 630-420-17   | 73 | 630-511-14      | 87  |
| 630-047-25  | 54 | 630-240-40    | 33 | 630-420-22   | 74 | 630-511-25      | 87  |
| 630-047-26  | 52 | 630-240-40B   | 30 | 630-420-24   | 74 | 630-511-25      | 90  |
| 630-047-26  | 54 | 630-240-40B-S | 30 | 630-420-27   | 74 | 630-511-50      | 89  |
| 630-047-30  | 52 | 630-240-41    | 36 | 630-420-32   | 73 | 630-511-55      | 89  |
| 630-047-30  | 54 | 630-240-45    | 33 | 630-420-34   | 73 | 630-511-60      | 89  |
| 630-048-00  | 51 | 630-240-45B   | 31 | 630-420-37   | 73 | 630-511-65      | 89  |
| 630-048-08  | 51 | 630-240-50    | 33 | 630-420-44   | 74 | 630-511-70      | 89  |
| 630-048-10  | 51 | 630-240-55    | 33 | 630-420-47   | 74 | 630-512-09      | 88  |
| 630-048-12  | 51 | 630-240-55B   | 31 | 630-420-52   | 73 | 630-512-13      | 88  |
| 630-048-14  | 51 | 630-240-60    | 33 | 630-420-54   | 73 | 630-512-14      | 88  |
| 630-048-58  | 51 | 630-240-60B   | 31 | 630-420-57   | 73 | 630-512-50      | 89  |
| 630-048-60  | 51 | 630-240-65    | 33 | 630-420-64   | 74 | 630-512-55      | 89  |
| 630-048-62  | 51 | 630-240-70    | 33 | 630-420-67   | 74 | 630-512-60      | 89  |
| 630-048-64  | 51 | 630-240-75B   | 31 | 630-423-12   | 76 | 630-512-65      | 89  |
| 630-049-00  | 54 | 630-240-90    | 34 | 630-423-17   | 76 | 630-512-70      | 89  |
| 630-200-24  | 32 | 630-240-95    | 34 | 630-430-00   | 76 | 630-515-13      | 90  |
| 630-200-27  | 36 | 630-300-19    | 41 | 630-430-09   | 76 | 630-515-14      | 90  |
| 630-202-24  | 32 | 630-304-01    | 41 | 630-430-12   | 76 | 630-515-50      | 90  |
| 630-202-27  | 36 | 630-304-21    | 41 | 630-430-15   | 76 | 630-515-55      | 90  |
| 630-204-06  | 28 | 630-309-01    | 41 | 630-430-18   | 76 | 630-515-60      | 90  |
| 630-204-07  | 28 | 630-309-21    | 41 | 630-430-21   | 76 | 630-515-65      | 90  |
| 630-204-08  | 35 | 630-315-19    | 41 | 630-430-24   | 76 | 630-516-13      | 90  |
| 630-204-26  | 28 | 630-325-19    | 41 | 630-430-27   | 76 | 630-516-14      | 90  |
| 630-204-26  | 28 | 630-335-10    | 40 | 630-430-30   | 76 | 630-516-50      | 90  |
| 630-204-28  | 35 | 630-335-10B   | 40 | 630-432-05   | 76 | 630-516-55      | 90  |
| 630-209-06  | 28 | 630-335-60    | 40 | 630-432-10   | 76 | 630-516-60      | 90  |
| 630-209-07  | 28 | 630-335-60B   | 40 | 630-435-15   | 79 | 630-516-65      | 90  |
| 630-209-08  | 35 | 630-340-00    | 42 | 630-435-20   | 79 | CBMO/66/1K      | 100 |
| 630-209-26  | 28 | 630-340-00B   | 42 | 630-435-25   | 79 | CBMO/66/1RES    | 100 |
| 630-209-26  | 28 | 630-340-00B-S | 42 | 630-435-30   | 79 | CBMO/74TRP      | 100 |
| 630-209-28  | 35 | 630-340-05    | 42 | 630-435-35   | 79 | DRSO/00-108-005 | 99  |
| 630-209-99  | 72 | 630-340-05B   | 42 | 630-435-40   | 79 | EMTO/FCS-5523R  | 7   |
| 630-215-24  | 29 | 630-340-05B-S | 42 | 630-435-45   | 79 | EMTO/FURS-2812R | 7   |
| 630-215-27  | 35 | 630-340-10    | 42 | 630-450-35   | 77 |                 |     |
| 630-220-24  | 29 | 630-340-10B   | 42 | 630-450-38   | 77 |                 |     |
| 630-220-27  | 35 | 630-340-10B-S | 42 | 630-451-35   | 77 |                 |     |
| 630-225-24  | 29 | 630-340-15    | 42 | 630-451-38   | 77 |                 |     |
| 630-225-27  | 35 | 630-340-15B   | 42 | 630-452-35   | 77 |                 |     |
| 630-230-09  | 88 | 630-340-15B-S | 42 | 630-452-38   | 77 |                 |     |
| 630-230-24  | 29 | 630-340-20    | 42 | 630-453-18   | 80 |                 |     |
| 630-230-27  | 35 | 630-350-05    | 38 | 630-454-18   | 80 |                 |     |
| 630-235-10  | 32 | 630-350-55    | 38 | 630-455-18   | 80 |                 |     |
| 630-235-10B | 27 | 630-350-90    | 38 | 630-461-16   | 80 |                 |     |
| 630-235-11  | 32 | 630-351-05    | 38 | 630-461-30   | 77 |                 |     |
| 630-235-60  | 32 | 630-351-55    | 38 | 630-470-35   | 77 |                 |     |
| 630-235-60B | 27 | 630-351-90    | 38 | 630-471-18   | 80 |                 |     |
| 630-235-61  | 32 | 630-352-05    | 38 | 630-471-30   | 77 |                 |     |



· WORLD WIDE DISTRIBUTION NETWORK ·



**TONTARRA Medizintechnik GmbH**

Daimlerstr. 15 · 78573 Wurmlingen/Germany

Tel: +49(0) 74 61/9 65 76 -0

Fax: +49(0) 74 61/9 65 76 -26

info@tontarra.de

[www.tontarra.de](http://www.tontarra.de)



The current digital e-catalogues  
can be found on our website:

<https://tontarra.de/en/products/e-catalogues>

All rights are reserved. Technical alterations are possible. This folder may be used for no other purpose than offering, buying and selling of our products. No part may be copied or reproduced in any form. In the case of misuse, we retain the rights to recall our catalogs and pricelists and to take legal actions.  
999-400-03E · Rev. 09/13.04.2023